

BALANCES & TEST SERVICE

Laboratory | Industry | Food Industry



PROFESSIONAL MEASURING

2025

It's so easy to order from KERN:

 Tel. +49 7433 9933-0

 E-Mail
info@kern-sohn.com

 Online Shop
www.kern-sohn.com

We look forward to meeting you
in our online shop – simply use the
QR Code:



Your Advantages – our Philosophy. All KERN Advantages at a Glance

Online Shop

www.kern-sohn.com

For convenient ordering you will find a huge selection of products and services in our KERN online shop, 24/7.

Advice from the experts

Our KERN experts will offer you individual advice in a range of languages and will be pleased to assist you:
Mon - Fri from 8.00 am to 5.00 pm

100 % product availability and dispatch service

With KERN you can be sure that you will have immediate access to the products you need – provided that they are in stock. Our 24-hour dispatch service will send your products immediately. Ordered today, on their way tomorrow!

Warranty

We offer you as the customer up to 3 years warranty on all products in our entire range, as an option the warranty can be extended for a small fee. Because our products deliver on their promises!

Customer service

Our customer service is personally available by telephone, e-mail or video call. We speak more than 7 languages and we will be happy to help with your requests.

Trust through experience

Experience counts in terms of weighing and measuring technology and this has been the case for 180 years – for the benefit of our customers. Put us to the test!

Accreditations/certification

- DAkkS accreditation
DIN EN ISO/IEC 17025
- Certified QM system DIN EN ISO 9001
- Conformity assessment in accordance with NAWID 2014/31/EU
- Medical certifications DIN EN ISO 13485 and 93/42/EEC or VO (EU) 2017/745

DAkkS calibrations

In the modern, accredited KERN calibration laboratory, we perform DAkkS calibrations for balances, test weights as well as for numerous other measuring devices. In addition we can offer calibrations on your premises. Of course, all services are in accordance with international standards.

Verification service

Our professional verification service offers conformity assessments and verification of balances and weights – for a feeling of security in compliance with legal requirements.

Individual customer solutions

We are the right partner for special customer requirements. KERN offers numerous modular system solutions for your very individual weighing requirements. Please contact us!

Service Portal

You can find aftersales support in our online service portal: Technical Support, help with questions or problems, etc.
www.kern-sohn.com/shop/en/Serviceportal/

Spare parts and repair service

In spite of reliable KERN quality: If you should ever need to make a complaint about our products, we will help you quickly, flexibly and in an unbureaucratic manner.

No storage costs

You have no storage costs – we maintain the storage. Direct dispatch of ordered goods to your customer is available, invoice will be issued to you (third party business).

Still got questions?

You can find all KERN Service Hotlines on page 5.

KERN Pictograms



Internal adjusting
Quick setting up of the balance's accuracy with internal adjusting weight (motordriven)



Adjusting program CAL
For quick setting up of the balance's accuracy. External adjusting weight required



EasyTouch
Suitable for the connection, data transmission and control through PC or tablet



Memory
Balance memory capacity, e.g. for article data, weighing data, tare weights, PLU etc.



Alibi memory
Secure, electronic archiving of weighing results, complying with the 2014/31/EU standard.



KERN Universal Port (KUP)
allows the connection of external KUP interface adapters, e.g. RS-232, RS-485, SB, Bluetooth, WIFI, Analogue, Ethernet etc. for the exchange of data and control commands, without installation effort



RS-232 Data interface
To connect the balance to a printer, PC or network



RS-485 Data interface
To connect the balance to a printer, PC or other peripherals. Suitable for data transfer over large distances. Network in bus topology is possible



USB Data interface
To connect the balance to a printer, PC or other peripherals



Bluetooth* Data interface
To transfer data from the balance to a printer, PC or other peripherals



WIFI Data interface
To transfer data from the balance to a printer, PC or other peripherals



Control outputs
(optocoupler, digital I/O)
To connect relays, signal lamps, valves, etc.



Analogue interface
to connect a suitable peripheral device for analogue processing of the measurements



Interface for second balance
For direct connection of a second balance



Network interface
For connecting the scale to an Ethernet network



KERN Communication Protocol (KCP)
It is a standardized interface command set for KERN balances and other instruments, which allows retrieving and controlling all relevant parameters and functions of the device. KERN devices featuring KCP are thus easily integrated with computers, industrial controllers and other digital systems



GLP/ISO log intern
The balance displays weight, date and time, independent of a printer connection



GLP/ISO log Printer
With weight, date and time. Only with KERN printers.



Piece counting
Reference quantities selectable. Display can be switched from piece to weight



Recipe level A
The weights of the recipe ingredients can be added together and the total weight of the recipe can be printed out



Recipe level B
Internal memory for complete recipes with name and target value of the recipe ingredients. User guidance through display



Totalising level A
The weights of similar items can be added together and the total can be printed out



Percentage determination
Determining the deviation in % from the target value (100 %)



Weighing units
Can be switched to e.g. nonmetric units. See balance model. Please refer to KERN's website for more details



Weighing with tolerance range (Checkweighing)
Upper and lower limiting can be programmed individually, e.g. for sorting and dosing. The process is supported by an audible or visual signal, see the relevant model



Hold function
(Animal weighing program)
When the weighing conditions are unstable, a stable weight is calculated as an average value



Protection against dust and water splashes IPxx
The type of protection is shown in the pictogram



Suspended weighing
Load support with hook on the underside of the balance



Battery operation
Ready for battery operation. The battery type is specified for each device



Rechargeable battery pack
Rechargeable set



Universal plug-in power supply
with universal input and optional input socket adapters for
A) EU, CH, GB
B) EU, CH, GB, US
C) EU, CH, GB, US, AUS



Plug-in power supply
230V/50Hz in standard version for EU, CH. On request GB, USA or AUS version available



Integrated power supply unit
Integrated in balance. 230V/50Hz standard EU. More standards e.g. GB, USA or AUS on request



Weighing principle Strain gauges
Electrical resistor on an elastic deforming body



Weighing principle Tuning fork
A resonating body is electromagnetically excited, causing it to oscillate



Weighing principle Electromagnetic force compensation
Coil inside a permanent magnet. For the most accurate weighings



Weighing principle Single cell technology
Advanced version of the force compensation principle with the highest level of precision



Conformity Assessment
The time required for conformity assessment is specified in the pictogram



DAkks calibration possible (DKD)
The time required for DAkks calibration is shown in days in the pictogram



Factory calibration (ISO)
The time required for Factory calibration is shown in days in the pictogram



Package shipment
The time required for internal shipping preparations is shown in days in the pictogram



Pallet shipment
The time required for internal shipping preparations is shown in days in the pictogram

KERN Models A-Z

| | |
|---------------------------------------|---------|
| 572 | 31 |
| A | |
| ABP | 50-51 |
| ABP-A | 52 |
| ABT-NM | 48 |
| ACS / ACJ | 46-47 |
| ADB / ADJ | 43 |
| ADS / ADT <small>NEW</small> | 49 |
| ALS-A / ALJ-A | 44-45 |
| B | |
| BFC | 120-121 |
| BIC | 117 |
| BID | 118-119 |
| BXC <small>NEW</small> | 122 |
| C | |
| CB Q1 / CB Q2 / CB P1 | 156 |
| CCA | 90-91 |
| CCS | 92-93 |
| CDS | 89 |
| CE Hx | 134 |
| CFS | 86 |
| CH | 165 |
| CIB | 83 |
| CJ P / CJ X | 159 |
| CKE | 87 |
| CO Y1 / CO Y2 / CO Y5 | 158 |
| CP P4 / CP Y4 / CP P1 / CP Y1 / CP P3 | 153 |
| CP P2 / CP P7 / CP P8 | 154 |
| CR Q1 / CR P1 / CR Y1 | 155 |
| CT Q1 / CT P1 / CT P2 | 157 |
| CPB | 85 |
| CXB/CXB-NM | 84 |
| D | |
| DAB | 54 |
| DBS | 55 |
| DE | 102-103 |
| DLB | 56 |
| DS | 111 |
| E | |
| ECB-N / ECE-N | 59 |
| EFS | 11 |
| EHA | 15 |
| EMB | 12 |
| EMB-V | 13 |
| EMS | 14 |
| EOB | 100 |
| EOC | 104-105 |
| EOE | 99 |
| EOS | 101 |
| EW-N / EG-N | 34 |
| EWJ | 30 |

| | |
|----------------|----|
| F | |
| FCB | 61 |
| FCE-N | 60 |
| FCF | 67 |
| FES / FEJ | 40 |
| FFN | 72 |
| FGE | 66 |
| FKB | 62 |
| FOB-LM | 68 |
| FOB-S / FOB-NS | 69 |
| FOB / FOB-NL | 70 |
| FXN / FXN-M | 73 |

| | |
|----------------|---------|
| H | |
| HCB | 167 |
| HCD | 169 |
| HCN | 168 |
| HDB-N / HDB-XL | 166 |
| HFA | 170 |
| HFC | 171 |
| HFD | 172-173 |
| HFM | 174 |

| | |
|----------|---------|
| I | |
| IFB | 110 |
| IFC | 108-109 |
| IFS | 88 |
| IOC | 106-107 |
| IXC | 112-113 |

| | |
|--------------|-----|
| K | |
| KBP-V20 IP65 | 148 |
| KDP | 135 |
| KFA-V20 | 150 |
| KFB-TM | 145 |
| KFC-TM | 146 |
| KFD-V20 | 149 |
| KFD-V40 IP68 | 151 |
| KFN-TM | 145 |
| KFP-V20 IP65 | 148 |
| KFP-V20 IP67 | 149 |
| KFP-V30 | 150 |
| KFP-V40 IP68 | 151 |
| KFS-TM | 144 |
| KFU-V20 | 150 |
| KFU-V30 | 150 |
| KGP | 132 |
| KIB-TM | 145 |
| KIP-V20M | 149 |
| KXC-TM | 147 |
| KXP-V20 IP65 | 148 |

| | |
|------------------------|-----|
| N | |
| NFC <small>NEW</small> | 129 |
| NIB | 128 |
| NXC <small>NEW</small> | 130 |

| | |
|-----------|-------|
| P | |
| PBJ / PBS | 37 |
| PCB | 26-27 |
| PCD | 24 |
| PCJ | 28-29 |
| PDS / PDT | 38-39 |
| PEJ / PES | 36 |
| PFB | 25 |
| PLJ / PLS | 32 |
| PNS / PNJ | 33 |
| PWS | 35 |

| | |
|----------|----|
| R | |
| RIB | 78 |
| RPB | 79 |

| | |
|-------------|-------|
| S | |
| SCD-4.0 | 179 |
| SCD-4.0-PRO | 180 |
| SFB / SFB-H | 76 |
| SFE | 114 |
| SXC | 74-75 |

| | |
|----------|---|
| T | |
| TGC | 9 |
| TGD | 9 |

| | |
|------------------------|-----|
| U | |
| UFA | 123 |
| UFC <small>NEW</small> | 126 |
| UIB | 124 |
| UID | 125 |
| UXC <small>NEW</small> | 127 |

| | |
|----------|-----|
| V | |
| VHB | 161 |

| | |
|----------|----|
| W | |
| WTB | 71 |

| | |
|--------------------|-----|
| Y | |
| YKV | 133 |
| YRO-01 / -02 / -03 | 185 |



KERN Quick-Finder

How I quickly find the product I am looking for

Ahead of each product group allows you to base the search for a certain target group on weighing data you need such as readout, weighing capacity and main features for each model.

And it's as simple as that – find the product you want in 2 steps:

1. Go to the product group index on page 3
2. Pick the appropriate product group and find the product you want using the Quick-Finder

Product Group Index 2025

Pocket Balances

1

8–9



School Balances

2

10–19



Precision Balances

3

20–41



Analytical Balances

4

42–52



Moisture Analysers

5

53–56



Bench Scales

6

57–62



Food (Kitchen, Stainless steel, IP65...68 Protection)

7

63–76



Price Computing Scales

8

77–79



Counting Scales, Counting Systems

9

80–94



Parcel Scales, Platform Scales

10

95–114



Floor Scales, Pallet Scales, Drive-through Scales

11

115–130

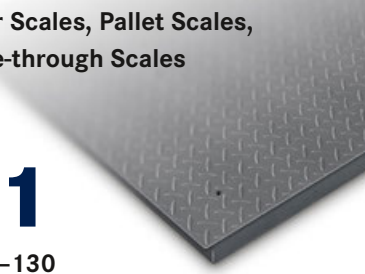

System Solutions KERN Industry 4.0, EasyTouch

12

131–139



Display Devices, Platforms, Weighing Bridges, Load Cells

13

140–159



Pallet Truck Scales

14

160–162



Hanging Scales, Crane Scales

15

163–174



Accessories, Software

16

175–185



Test Weights

17

186–215



Accredited Calibration, Verification Service

18

216–228



Do you have questions about our products?

Our customer consultants will be pleased to assist you

UK, BE, IE, IS, LU, NL



Maren Neff
Area Sales Manager
Tel. +49 7433 9933-132
Mobil +49 151 46143240
maren.neff@kern-sohn.com

UK, IE IS



Leila Kenan
Back Office
Tel. +49 7433 9933-153
leila.kenan@kern-sohn.com

PL, LV, LT, EE, SK, CZ, HU



Mark Hauder
Area Sales Manager
Tel. +49 7433 9933-310
Mobil +49 160 3378426
mark.hauder@kern-sohn.com



Rebecca Schäfer
Back Office
Tel. +49 7433 9933-119
rebecca.schaefer@kern-sohn.com

GR, CY, BG, RO, AL, Ex-Yugoslavia, GUS

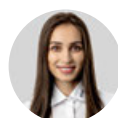

Ariana Sevcenco
Area Sales Manager
Tel. +49 7433 9933-203
Mobil +49 151 72434692
ariana.sevcenco@kern-sohn.com



Inna Wandler
Back Office
Tel. +49 7433 9933-167
inna.wandler@kern-sohn.com



Rebecca Schäfer
Back Office
Tel. +49 7433 9933-119
rebecca.schaefer@kern-sohn.com

North America, Near- & Middle East, Africa, Asia, Oceania, TR



Corinna Matthes
Area Sales Manager
Tel. +49 7433 9933-215
Mobil +49 151 44568364
corinna.matthes@kern-sohn.com



Corinna Matthes
Back Office
Tel. +49 7433 9933-215
Mobil +49 151 44568364
corinna.matthes@kern-sohn.com

DAkkS Calibration Service Inhouse, Test weights, balances & measuring instruments



Lars Wagner
Tel. +49 7433 9933-255
lars.wagner@kern-sohn.com



Karl-Richard Fuchs
Tel. +49 7433 9933-136
testservices-onsite@kern-sohn.com

General Manager



Albert Sauter
Tel. +49 7433 9933-157
albert.sauter@kern-sohn.com

Head of Division
Sales and Marketing



Stephan Ade
Tel. +49 7433 9933-121
Mobil +49 171 3060086
ade@kern-sohn.com

Marketing Manager,
Deputy Sales Manager



Hendrik Neff
Tel. +49 7433 9933-161
Mobil +49 171 3059946
hendrik.neff@kern-sohn.com

Team Manager
Marketing & Communications



Katharina Faradacco
Tel. +49 7433 9933-192
katharina.faradacco@kern-sohn.com

KERN Category Manager

You need advice and help or have special requests? Our service for you: our category managers advise you on all topics and look for the right product solution for your individual requirements. By telephone or by e-mail, just as it is most convenient for you.



Laboratory

Aleksandar Delić
Team Leader
Tel. +49 7433 9933-120
Mobil +49 151 11196197
aleksandar.delic@kern-sohn.com



Test Weights

Taras Mikitisin
Tel. +49 7433 9933-143
Mobil +49 171 5590115
mikitisin@kern-sohn.com



Medical Sector

Jobst Kamal
Tel. +49 7433 9933-268
Mobil +49 151 67010975
jobst.kamal@kern-sohn.com



Software EasyTouch

Wolfgang Schäfer
Tel. +49 7433 9933-324
Mobil +49 170 2723266
etsales@kern-sohn.com

KERN Hotlines

Technical questions about our products?

You will find assistance here quickly: +49 7433 9933- ...



Service Hotline

for general technical questions about your KERN product

→ 199

System Solutions Industry 4.0

for all technical questions concerning the interlocking of the latest information and communication technology with our scales, load cells and measuring devices as well as questions about KERN software

→ 200

Industrial Scales

for all technical questions concerning our basic scales (laboratory & industry), pocket balances, school balances, bench scales, price-computing scales, platform scales, counting scales, counting systems, floor scales, pallet truck scales, crane scales, veterinary scales

→ 333

Laboratory and Analytical Balances

for all technical questions concerning our high quality precision balances, analytical balances (especially with electromagnetic force-compensated measuring systems, tuning fork and high application density)

→ 444

Medical Scales

for all technical questions concerning our baby scales, personal scales, handrail scales, chair scales, wheelchair scales, dynamometers

→ 499

SAUTER measuring instruments

for all technical questions concerning our SAUTER measuring instruments, test benches, force measuring accessories (clamps etc.), SAUTER software

→ 555

Moisture Analysers

for all technical questions concerning our moisture analysers

→ 599

Optical Devices

for all technical questions concerning our microscopes, microscope cameras, refractometers, etc.

→ 777

EasyTouch (Software)

for all technical questions about the installation and commissioning of the EasyTouch software

→ 322

NEW IN → 2025



Innovative technology, new features, outstanding performance. In the Food and Industry sectors we have gone all out for you. You will be impressed by our new products for 2025!

NEW



Versatile, precise, accurate

→ **Precision Balance KERN PDS/PDT**

Precision balance with innovative touch display combines the most modern technology and versatile functions such as statistics, counting function and percentage weighing. Ideal for the pharmaceutical industry, it supports the highest data integrity in accordance with FDA standards. Interfaces mean that weight values can be transferred easily. Includes draft shield and suspended weighing for maximum precision.

For details, see *Precision Balances*

NEW

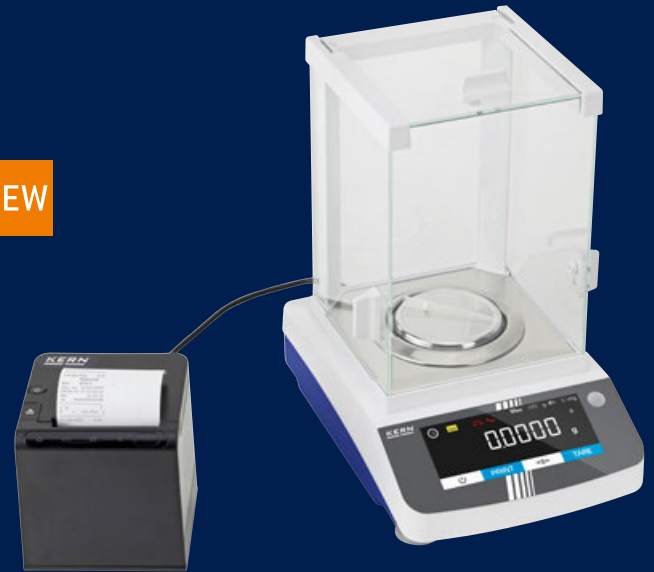

Precision redefined

→ **Analytical Balance KERN ADS/ADT**

Our analytical balance with touch display offers a wide range of functions, from statistics to percentage weighing. Ideal for the pharmaceutical industry and the laboratory.

For details, see *Analytical Balances*

NEW



Compact and reliable

→ **Thermal Printer KERN YKC-01**

The ideal addition to your scales. Perfect for documenting weighing data and for daily use.

For details, see *Accessories*

NEW



Perfect protection for precision

→ **Clean Room Boxes**

The KERN weight boxes made of high-quality polyoxymethylene (POM) have been specially developed for cleanroom and laboratory environments and provide optimum protection for test weights. Thanks to the robust, edge-free design, the cases are particularly hygienic and easy to clean.

Suitable for weight classes E1 to M1, they fulfil the highest cleanliness standards, are resistant to numerous cleaning agents and disinfectants and are even suitable for thermal disinfection. Antistatic versions are also available on request.

For details, see *Test weights*

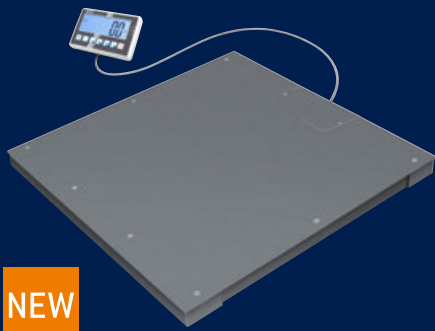

NEW

The precise solution for heavy loads
→ **Floor Scale KERN BFC**

Ideal for the highest demands – with stable XXL weighing plate and IoT functionality.

For details, see *Floor Scales*

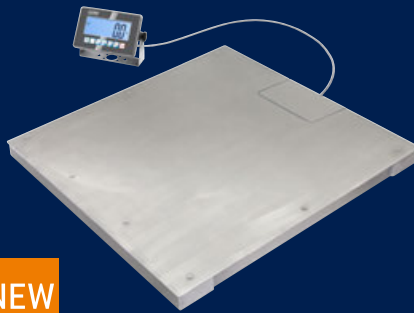

NEW

Robust performance for any challenge
→ **Stainless Steel Floor Scale**
KERN BXC

With various interfaces and optional alibi memory, it adapts to individual requirements and is therefore the perfect partner for industrial applications.

For details, see *Floor Scales*

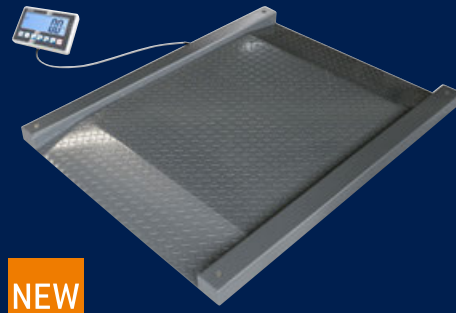

NEW

Efficiency through networking
→ **Drive-Through Scale KERN NFC**

Especially suitable for the rapid weighing seasonings, ingredients etc. Thanks to the robust anti-slip corrugated steel and IP67 protection of the weighing bridge, it is ideally equipped for daily use.

For details, see *Drive-Through Scales*

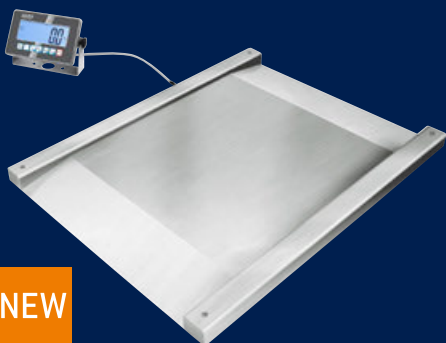

NEW

Flexible, robust, networkable
→ **Stainless Steel Drive-Through Scale**
KERN NXC

Optimise your processes with our IoT-enabled stainless-steel drive-on scale. Thanks to the flexible interfaces and robust design, it is suitable for a wide range of applications.

For details, see *Drive-Through Scales*



NEW

Flexible and mobile for any location
→ **Pallet Scale KERN UFC**

Perfect for flexible use. The robust steel load support and the silicone-coated load cells ensure a long service life and precise results.

For details, see *Pallet Scales*



NEW

Hygiene meets engineering
→ **Stainless Steel Pallet Scale**
KERN UXC

The perfect solution for the food industry. The stainless-steel load support and the high IP protection classes ensure maximum hygiene and durability.

For details, see *Pallet Scales*

1







POCKET BALANCES

Pocket size precision

Pocket balances are the ideal helpers whenever mobility and high precision are required. Since they have fewer keys, operation is simple and fast. Different weighing units stored in the pocket balance, such as g, oz, ct, gn, etc., make them universally usable. Compact in size and well protected with a flap or protective cover, which can be used as a convenient taring container, the pocket balance is always a useful tool for mobile weighing.

- In production, to control of production weights or during the picking of small parts
- In quality control for the quick testing of small parts like plastic parts from injection moulding machines, milled parts, screws, etc.
- For mobile weighing, on-site sampling, and fast analysis wherever there's no power outlet
- In hobbies and sports, e.g. when filling gun powder, weighing parts from modelling kits etc.
- In commerce, for the fast determination of the weights of coins, jewellery, precious stones, etc.
- In the veterinary sector for the weighing of small animals, the mixing of food, etc.
- In the food sector for the preparation of spice or tea mixes, for the weighing of food in line with a diet sheet

Quick-Finder Pocket Balances

| Readout | Weighing capacity | Model | Price | Page |  |  |  |
|---------|-------------------|---|--------------|------|---|---|---|
| [d] | [Max] | KERN | excl. of VAT | | For an explanation on the pictos, see the front flap | | |
| g | g | | ex works | | | | |
| | | | € | | | | |
| 0,001 | 50 | TGD 50-3C  | 72,- | 9 | ● | ● | ● |
| 0,01 | 150 | TGC 150-2 | 40,- | 9 | ● | ● | ● |
| 0,1 | 500 | TGC 500-1 | 35,- | 9 | ● | ● | ● |
| 1 | 1000 | TGC 1K-3 | 40,- | 9 | ● | ● | ● |

 = Carat balance

● Standard ○ Option



Slim pocket balance with large stainless steel weighing plate and practical tare pan

Features

- High-resolution pocket balance with particularly rapid reaction and stabilisation time, which means that you can work extremely efficiently
- Particularly flat design
- **1** Cover made of shock proof plastic as protection against pressure and dust. Can also be used as a tare cup
- Stainless steel weighing plate, which makes cleaning easy and hygienic
- Ready for use: Batteries included, 2×CR2032, operating time up to 8,75 h. Integrated AUTO-OFF function after 4 minutes to preserve the batteries



STANDARD OPTION

CAL EXT
 UNIT
 BATT
 1 DAY
 DAkkS
 +3 DAYS



Compact pocket carat balance for precision weighing of jewellery and precious stones

Features

- Simple and convenient 4-key operation
- Can be switched over from g to ct, gn, dwt, ozt, oz at the touch of a key
- Large touch-sensitive, backlit touch display with very good contrast for easy operation and convenient reading
- Hard case cover as protection against pressure and dust
- Stainless steel weighing plate, which makes cleaning easy and hygienic
- Weighing pan standard
- Powder scale with Grain division (gn), ideal for sport shooters, reloaders etc. for self-filling cartridge cases
- USB cable for power supply as standard
- Ready for use: Batteries included, 4×1.5 V AAA, operating time up to 150 h. Integrated AUTO-OFF function after 5 minutes to preserve the batteries
- **2** Delivered in single design packaging



| KERN Model | TGC 150-2 | TGC 500-1 | TGC 1K-3 | TGD 50-3C |
|---|-------------|------------------|-------------|------------------|
| Weighing capacity [Max] g | 150 | 500 | 1000 | 50 250 ct |
| Readability [d] g | 0,01 | 0,1 | 1 | 0,001 0,005 ct |
| LCD display - backlit | | yes | | yes |
| LCD display - digit height | | 12 mm | | 20 mm |
| Dimensions of weighing surface W×D | | 81 mm | | 65 mm |
| Overall dimensions W×D×H | | 100×130×18 mm | | 96×150×64 mm |
| Net weight | 200 g | 150 g | 150 g | 250 g |
| Permissible ambient temperature | | 0 °C - 40 °C | | 5 °C - 35 °C |
| Price, excl. of VAT, ex works, € | 40,- | 35,- | 40,- | 72,- |
| Option DAkkS Calibr. Certificate | | 963-127, € 103,- | | 963-127, € 103,- |

2



SCHOOL BALANCES

As entry-level models, KERN school balances cover the most important basic applications of laboratory balances and offer simple operation, easy readability and an optimal price-performance ratio. The KERN School balances can be used flexibly and independent of location thanks to battery operation and are therefore the ideal choice for school or teaching purposes.

Our recommendation: the KERN EFS school balance in our product range, a space-saving and inexpensive allrounder for school teaching programs and universities.

Quick-Finder School Balances

| Readout | Weighing capacity | Model | Price excl. of VAT | Page | | | | | | |
|----------|-------------------|---------------|--------------------|------|--|---|---|---|---|---|
| [d] g | [Max] g | KERN | € | | For an explanation on the pictos, see the front flap | | | | | |
| 0,001 | 100 | EMB 100-3 | 225,- | 12 | ● | | | | ○ | ● |
| 0,001 | 200 | EMB 200-3 | 240,- | 12 | ● | | | | ○ | ● |
| 0,001 | 200 | EMB 200-3V | 275,- | 13 | ● | ● | | | ○ | ● |
| 0,001 | 300 | EMS 300-3 | 300,- | 14 | ● | | ● | | ○ | ● |
| 0,01 | 200 | EMB 200-2 | 135,- | 12 | ● | | | | ○ | ● |
| 0,01 | 500 | EHA 500-2 | 93,- | 15 | ● | | ● | ● | | ● |
| 0,01 | 500 | EFS 500-2 | 120,- | 11 | ● | | | | ○ | ● |
| 0,01 | 600 | EMB 600-2 | 175,- | 12 | ● | | | | ○ | ● |
| 0,01 | 1000 | EMB 1000-2 | 220,- | 12 | ● | | | | ○ | ● |
| 0,01 | 2000 | EMB 2000-2 | 235,- | 12 | ● | | | | ○ | ● |
| 0,01 | 2000 | EMB 2000-2V | 270,- | 13 | ● | ● | | | ○ | ● |
| 0,01 | 3000 | EMS 3000-2 | 260,- | 14 | ● | | ● | | ○ | ● |
| 0,1 | 220 | EFS 200-1S05 | 194,- | 11 | ● | | | | ○ | ● |
| 0,1 | 500 | EMB 500-1 | 60,- | 12 | ● | | | | ○ | ● |
| 0,1 | 500 | EMB 500-1BE | 60,- | 12 | ● | | | | ○ | ● |
| 0,1 | 500 | EHA 500-1 | 68,- | 15 | ● | | ● | ● | ○ | ● |
| 0,1 | 620 | EFS 600-1S05 | 200,- | 11 | ● | | | | ○ | ● |
| 0,1 | 1000 | EHA 1000-1 | 73,- | 15 | ● | | ● | ● | | ● |
| 0,1 | 1200 | EMB 1200-1 | 80,- | 12 | ● | | | | ○ | ● |
| 0,1 | 3000 | EHA 3000-1 | 93,- | 15 | ● | | ● | ● | | ● |
| 0,1 | 3000 | EFS 3000-1 | 100,- | 11 | ● | | | | ○ | ● |
| 0,1 | 3000 | EMB 3000-1 | 135,- | 12 | ● | | | | ○ | ● |
| 0,1 | 6000 | EMB 6000-1 | 175,- | 12 | ● | | | | ○ | ● |
| 0,1 | 6000 | EMS 6K0.1 | 185,- | 14 | ● | | ● | | ○ | ● |
| 0,1 | 12000 | EMS 12K0.1 | 230,- | 14 | ● | | ● | | ○ | ● |
| 1 | 2200 | EMB 2200-0 | 60,- | 12 | ● | | | | ○ | ● |
| 1 | 2200 | EFS 2000-0S05 | 194,- | 11 | ● | | | | ○ | ● |
| 1 | 3000 | EHA 3000-0 | 68,- | 15 | ● | | ● | ● | | ● |
| 1 | 5200 | EMB 5.2K1 | 60,- | 12 | ● | | | | ○ | ● |
| 1 | 5200 | EFS 5000-0S05 | 200,- | 11 | ● | | | | ○ | ● |
| 1 | 6000 | EMS 6K1 | 95,- | 14 | ● | | ● | | ○ | ● |
| 1 | 12000 | EMS 12K1 | 100,- | 14 | ● | | ● | | ○ | ● |
| 5 | 5200 | EMB 5.2K5 | 56,- | 12 | ● | | | | ○ | ● |

● Standard ○ Option

SET
5x



2



Perfect school balances for experimental teaching – easy to use, space-saving, stackable

Features

- Simple and convenient 2-key operation, making them ideal for use in schools and universities
- Tare function facilitates formulation work
- Particularly flat design
- Secure and non-slip positioning with rubber feet
- **1** Stackable for space-saving storage
- **2** Practical battery operation using standard batteries ensures a high level of flexibility and freedom from mains adapters, sockets, chargers, etc.

Technical data

- Large LCD display, digit height 15 mm
- Dimensions weighing surface, plastic, WxD 134x127 mm
- Overall dimensions WxDxH 145x205x46,5 mm
- Battery operation, 4x1.5 V AA standard, operating time up to 200 h. Integrated AUTO-OFF function to preserve the batteries
- Net weight approx. 0,45 kg
- Permissible ambient temperature 10 °C/40 °C

Accessories

- External universal mains adapter, with universal input and optional input socket adapters for EU, CH, GB, US, KERN YKA-27, **€ 43,-**

Note: The models with the suffix -S05 are delivered in a set of 5 units. i.e. the price given in the table refers to 5 items. Cannot be delivered individually

STANDARD



OPTION



| Model | Weighing capacity [Max] g | Readability [d] g | Reproducibility g | Linearity g | Quantity delivered (balance) | Price excl. of VAT ex works € | Options | |
|----------------|---------------------------------|-------------------------|----------------------|----------------|---------------------------------|--|---------------|--------------------------|
| | | | | | | | DAkKS KERN | Calibr. Certificate € |
| KERN EFS 500-2 | 500 | 0,01 | 0,01 | ± 0,03 | 1 | 120,- | 963-127 | 103,- |
| EFS 200-1S05 | 220 | 0,1 | 0,1 | ± 0,3 | 5 | 194,- | 963-127S05 | 515,- |
| EFS 600-1S05 | 620 | 0,1 | 0,1 | ± 0,3 | 5 | 200,- | 963-127S05 | 515,- |
| EFS 3000-1 | 3000 | 0,1 | 0,1 | ± 0,3 | 1 | 100,- | 963-127 | 103,- |
| EFS 2000-0S05 | 2200 | 1 | 1 | ± 3 | 5 | 194,- | 963-127S05 | 515,- |
| EFS 5000-0S05 | 5200 | 1 | 1 | ± 3 | 5 | 200,- | 963-128S05 | 620,- |



Entry level laboratory balance with tremendous weighing performance

Features

- Simple and convenient 2-key operation
- Tare function facilitates formulation work
- Particularly flat design
- Ready for use: Batteries included
- **A** Ring-shaped draught shield standard, only for models with weighing plate size **A**, weighing space $\varnothing \times H$ 96×35 mm
- Hook for underfloor weighing standard
- **1** Also available as KERN EMB 500-1BE Black Edition
- Note: With the optional auxiliary set for density determination KERN YDB-04 also well suited for school and teaching operation, see *Accessories*

Technical data

- Large LCD display, digit height 15 mm
- Dimensions weighing surface
 - A** \varnothing 82 mm, plastic, with conductive lacquer
 - B** \varnothing 105 mm, plastic
 - C** \varnothing 150 mm, plastic, see larger picture
- Overall dimensions W×D×H
 - A** 170×244×54 mm
 - B, C** 170×244×39 mm
- Batteries included, 9 V block, respectively 2×1.5 V AA
- Net weight approx. 0,85 kg
- Permissible ambient temperature 5 °C/35 °C

Accessories

- Stainless steel weighing plate, only for models with weighing plate size **B**, KERN EMB-A02, **€ 29,-**
- Rechargeable battery pack external, operating time up to 50 h without backlight, charging time approx. 10 h, KERN KS-A01, **€ 180,-**
- External universal mains adapter, with universal input and optional input socket adapters for EU, CH, GB, US, KERN YKA-03N, **€ 38,-**
- **2** Suitable for models with weighing plate size **A**: Ancillary kit for density determination of liquids and solids with density > 1. Scope of supplies: Bridge for holding the beaker (\varnothing 102 mm), hook (H 139 mm), KERN YDB-04, **€ 27,-**

STANDARD



OPTION

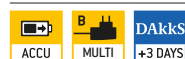

| Model | Weighing capacity [Max] g | Readability [d] g | Reproducibility g | Linearity g | Weighing plate | Price excl. of VAT ex works € | Options | |
|--------------------|---------------------------------|-------------------------|----------------------|----------------|----------------|--|---------------|--------------------------|
| | | | | | | | DAKKS KERN | Calibr. Certificate € |
| KERN | | | | | | | | |
| EMB 100-3 | 100 | 0,001 | 0,001 | ± 0,005 | A | 225,- | 963-127 | 103,- |
| EMB 200-3 | 200 | 0,001 | 0,001 | ± 0,005 | A | 240,- | 963-127 | 103,- |
| EMB 200-2 | 200 | 0,01 | 0,01 | ± 0,02 | B | 135,- | 963-127 | 103,- |
| EMB 600-2 | 600 | 0,01 | 0,01 | ± 0,03 | B | 175,- | 963-127 | 103,- |
| EMB 1000-2 | 1000 | 0,01 | 0,01 | ± 0,05 | C | 220,- | 963-127 | 103,- |
| EMB 2000-2 | 2000 | 0,01 | 0,01 | ± 0,05 | C | 235,- | 963-127 | 103,- |
| EMB 500-1 | 500 | 0,1 | 0,1 | ± 0,2 | C | 60,- | 963-127 | 103,- |
| EMB 500-1BE | 500 | 0,1 | 0,1 | ± 0,2 | C | 60,- | 963-127 | 103,- |
| EMB 1200-1 | 1200 | 0,1 | 0,1 | ± 0,3 | C | 80,- | 963-127 | 103,- |
| EMB 3000-1 | 3000 | 0,1 | 0,1 | ± 0,3 | C | 135,- | 963-127 | 103,- |
| EMB 6000-1 | 6000 | 0,1 | 0,1 | ± 0,3 | C | 175,- | 963-128 | 124,- |
| EMB 2200-0 | 2200 | 1 | 1 | ± 2 | C | 60,- | 963-127 | 103,- |
| EMB 5.2K1 | 5200 | 1 | 1 | ± 3 | C | 60,- | 963-128 | 124,- |
| EMB 5.2K5 | 5200 | 5 | 5 | ± 10 | C | 56,- | 963-128 | 124,- |



School balance with integrated density determination function

Features

- Self-explanatory, graphic control panel
 - no learning time = reduces costs
 - ideal for untrained users
 - visualised process avoids operating errors.
- Note: Balance and appropriate set for density determination should be ordered at the same time, see *Accessories*
- Hook for underfloor weighing standard
- Self-explanatory, graphic control panel, the workings steps can be understood immediately, even without operating instructions
 - no learning time = reduces costs
 - ideal for untrained users
 - visualised process avoids operating errors
- The 4 steps are carried out from left to right:
 - 1 Tare the balance by pressing the [TARE] key
 - 2 Select density determination mode (solids/liquids)
 - 3 Weighing of samples/plummet in air
 - 4 Weighing of samples/plummet in liquid. The density will be shown on the display right away
- Particularly flat design

Technical data

- Large LCD display, digit height 15 mm
- Dimensions weighing surface, plastic
 - A** \varnothing 82 mm
 - B** \varnothing 150 mm, see larger picture
- Overall dimensions WxDxH 175x250x55 mm
- Batteries included, 9 V block, operating time up to 12 h, AUTO-OFF function preserves the battery
- Net weight approx. 0,85 kg
- Permissible ambient temperature 5 °C/35 °C
- Also with carat weighing unit:
 EMB 200-3V: [Max] 1000 ct/[d] 0,005 ct
 EMB 2000-2V: [Max] 10000 ct/[d] 0,05 ct

Accessories

- Rechargeable battery pack external, operating time up to 50 h without backlight, charging time approx. 10 h, KERN KS-A01, **€ 180,-**

KERN EMB 200-3V:

- **5** Ancillary kit for density determination of liquids and solids with density > 1. Scope of supplies: Bridge for holding the beaker (\varnothing 102 mm), hook (H 139 mm), KERN YDB-04, **€ 27,-**
- **6** Set for density determination of liquids and solids with density \leq/ \geq 1. Scope of delivery: Weighing plate, beaker (Hx \varnothing 71x51 mm), sample holder, plummet, KERN YDB-01, **€ 270,-**
- DAkkS-Calibration certificate for the plummet (20 g), KERN 962-335V, **€ 175,-**

KERN EMB 2000-2V:

- **7** Set for density determination of liquids and solids with density \leq/ \geq 1. Scope of delivery: Weighing plate, beaker (Hx \varnothing 135x100 mm), sample holder, plummet KERN YDB-02, **€ 470,-**
- DAkkS-Calibration certificate for the plummet (200 g), KERN 962-338V, **€ 172,-**
- Thermometer, KERN YDB-A03, **€ 38,-**

STANDARD



OPTION

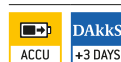

| Model | Weighing capacity [Max] | Readability [d] | Reproducibility g | Linearity g | Weighing plate | Price excl. of VAT ex works € | Options | |
|-------------|----------------------------|--------------------|----------------------|----------------|----------------|--|---------------|--------------------------|
| | | | | | | | DAkkS KERN | Calibr. Certificate € |
| KERN | | | | | | | | |
| EMB 200-3V | 200 | 0,001 | 0,002 | \pm 0,005 | A | 275,- | 963-127 | 103,- |
| EMB 2000-2V | 2000 | 0,01 | 0,02 | \pm 0,05 | B | 270,- | 963-127 | 103,- |



Entry level model in the low-cost range with large weighing plate

Features

- Especially suitable for use in schools and universities, for example for biology, chemistry, physics
- Large, shock proof weighing plate made of plastic
- Particularly flat design
- Ergonomically optimised key pad with large keys and a high-contrast LCD display
- Secure and non-slip positioning with rubber feet
- Adjusting program CAL for quick setting of the balance accuracy, external test weights at an additional price, see *Test Weights*
- **A** Draught shield standard for models with weighing plate size **A**, weighing space W×D×H 145×145×65 mm

Technical data

- Large LCD display, digit height 25 mm
- Dimensions weighing surface
 - A** ø 105 mm, plastic, with conductive lacquer
 - B** W×D 175×190 mm, plastic, see larger picture
- Overall dimensions W×D×H 200×280×65 mm
- Optional battery operation, 9 V block not included in scope of delivery, operating time up to 40 h
- Mains adapter external, standard
- Net weight approx. 1,4 kg
- Permissible ambient temperature 5 °C/35 °C

Accessories

- **1** Stainless steel weighing plate, only for models with weighing plate size **B**, KERN EMS-A01, **€ 33,-**
- Rechargeable battery pack external, operating time up to 50 h without backlight, charging time approx. 10 h, KERN KS-A01, **€ 180,-**

STANDARD



OPTION



| Model | Weighing capacity [Max] g | Readability [d] g | Reproducibility g | Linearity g | Weighing plate | Price excl. of VAT ex works € | Options | |
|-----------------|---------------------------------|-------------------------|----------------------|----------------|----------------|--|---------------|--------------------------|
| | | | | | | | DAkKS KERN | Calibr. Certificate € |
| KERN EMS 300-3 | 300 | 0,001 | 0,002 | ± 0,005 | A | 300,- | 963-127 | 103,- |
| KERN EMS 3000-2 | 3000 | 0,01 | 0,02 | ± 0,05 | B | 260,- | 963-127 | 103,- |
| KERN EMS 6K0.1 | 6000 | 0,1 | 0,1 | ± 0,3 | B | 185,- | 963-128 | 124,- |
| KERN EMS 12K0.1 | 12000 | 0,1 | 0,1 | ± 0,3 | B | 230,- | 963-128 | 124,- |
| KERN EMS 6K1 | 6000 | 1 | 1 | ± 3 | B | 95,- | 963-128 | 124,- |
| KERN EMS 12K1 | 12000 | 1 | 1 | ± 3 | B | 100,- | 963-128 | 124,- |



The compact all-round model with robust stainless steel weighing plate for use in laboratories, industries, and for teaching

| | | |
|-----------------|-----------------------|--------------------|
| Features | Technical data | Accessories |
|-----------------|-----------------------|--------------------|

- Thanks to its compact, robust design, its bright display and high precision, this range is ideal for use in laboratories, quality control, production as well in schools and universities for teaching
- Large, shock proof weighing plate made from stainless steel, can be removed and therefore is hygienic and easy to clean
- **1** Particularly flat design
- Ergonomically optimised key pad with large keys and a high-contrast LCD display
- **2** Secure and non-slip positioning with rubber feet
- Level indicator and levelling feet for precise levelling of the scale, fitted as standard, to give the most accurate weighing result
- Adjusting program CAL for quick setting of the balance accuracy, external test weights at an additional price, see *Test weights*

- Large backlit LCD display, digit height 22 mm
- Dimensions weighing surface, stainless steel
 - A** \varnothing 105 mm
 - B** WxD 120x120 mm, see larger picture
- Overall dimensions WxDxH 225x160x50 mm
- Optional battery operation, 2x1.5 V AA not included in scope of delivery, operating time up to 70 h
- Mains adapter external, standard
- Net weight approx. 0,50 kg
- Permissible ambient temperature 5 °C/40 °C

- US-Plug, KERN YKA-40-US, € 26,-

| | | | | | | | | | |
|---|---------------|--|--|--|--|--|--|---|--|
| STANDARD | OPTION | | | | | | | | |
| <table border="0" style="width: 100%;"> <tr> <td></td> <td></td> <td></td> <td></td> <td></td> <td></td> <td></td> </tr> </table> | | | | | | | | <table border="0" style="width: 100%;"> <tr> <td></td> </tr> </table> | |
| | | | | | | | | | |
| | | | | | | | | | |

| Model | Weighing capacity [Max] g | Readability [d] g | Reproducibility g | Linearity g | Weighing plate | Price excl. of VAT ex works € | Options | |
|------------|---------------------------------|-------------------------|----------------------|----------------|----------------|--|---------------|--------------------------------|
| | | | | | | | DAkkS KERN | DAkkS Calibr. Certificate € |
| EHA 500-2 | 500 | 0,01 | 0,03 | ± 0,03 | A | 93,- | 963-127 | 103,- |
| EHA 500-1 | 500 | 0,1 | 0,3 | ± 0,3 | A | 68,- | 963-127 | 103,- |
| EHA 1000-1 | 1000 | 0,1 | 0,3 | ± 0,3 | B | 73,- | 963-127 | 103,- |
| EHA 3000-1 | 3000 | 0,1 | 0,3 | ± 0,3 | B | 93,- | 963-127 | 103,- |
| EHA 3000-0 | 3000 | 1 | 3 | ± 2 | B | 68,- | 963-127 | 103,- |

WHEN DESIGN MEETS PERFORMANCE

Experience the KERN brand universe of the future with the innovative models in the KERN IoT Line – for modern, effective weighing. New pioneering KERN design, standardised and simplified operation, high levels of connectivity and stunning performance, and it works consistently across all devices. This is how we weigh today!



Performance

- + Cross-device functionality and protocols
- + Consistently reliable performance
- + The latest technologies
- + Cross-device functionality and protocols



Design

- + Trend-setting, high-quality KERN design
- + Recognisability through uniform product range
- + Reliable brand values are reflected visually and functionally in the product



Philosophy

- + Sustainable due to high energy efficiency
- + Standardisation of design components across all units
- + Controlled value chain
- + Tested and monitored technology for maximum user safety





Are you curious about the models in the KERN IoT range and what opportunities they offer?

Then take a look at the following pages, because thanks to new technologies such as KUP and KCP these models are perfectly equipped for the wide range of challenges of Industry 4.0



User Interface

- + Uniform, simplified user guidance
- + Problem-free commissioning, use and expansion
- + Cross-model software



Service

- + Fast and competent help from our IoT specialists
- + Even more efficient repair process
- + Accessories can be flexibly combined



Note: Our KERN IoT accessories can be easily combined with all our IoT models.

Find the right printer and other practical accessories in *Accessories* and on the internet www.kern-sohn.com

ARE YOU READY?

With the KERN Universal Port (KUP) or the KERN Universal Module (KUM) and the KERN Communication Protocol (KCP) we ensure the perfect integration of your KERN balance into production or process chains for a complete, simplified work process. Can also be easily retrofitted without affecting the conformity evaluation.

Our products will make sure you are prepared for the future of weighing in the Internet of Things. Get IoT ready – with the IoT models from KERN.

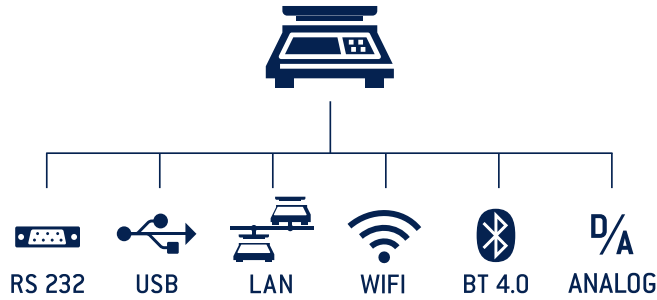

Robust industrial models from KERN for the very best integration into workflows



KERN Universal Port (KUP)

The KERN Universal Port (KUP) allows the connection of external KUP interface adapters such as RS-232, USB, Bluetooth, WiFi, Analogue, Ethernet etc.

The outstanding advantage here is that the KUP interface adapters are simply plugged in, i.e. retrofitting interfaces is conveniently possible without opening the scale housing or complicated installation.

The interface adapters enable convenient transmission of weighing data to networks, PCs, smartphones, tablets, laptops, printers etc. In addition, control commands and data inputs can also be sent to the scale via the connected devices.

The KERN Universal Module (KUM) is already built into the device and is particularly suitable for use in wet areas up to IP68.

KERN interface adapter

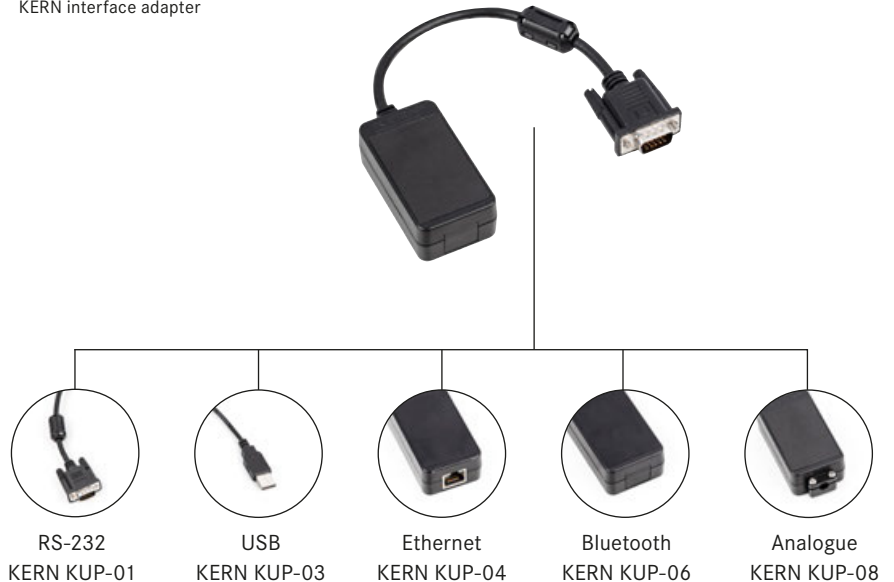

Still have questions?

We will be happy to give you more comprehensive information on this topic – talk to us:

Hotline +49 7433 9933-0
www.kern-sohn.com



Tip: With the KERN KUP-13 extension box, up to three KUP interface adapters can be operated in parallel on the scale.

KERN Communication Protocol (KCP)

The KERN Communication Protocol (KCP) permits searching and remote control of the balance through computers or CRM/ERP systems using the KERN Communication Protocol. KCP is a standardised interface command structure for KERN balances and other measuring instruments which allows you to recall and manage all relevant parameters and device functions. You can therefore simply connect KERN models with KCP to computers, industrial control systems and other digital systems.

In a large number of cases the KERN Communication Protocol is compatible with the MT-SICS protocol. KCP is available through all KUPs and KUMs.

KCP – Export (“Outbound”) – the Highlights

- Stable, immediate weight
- Live transfer of weights
- Storing of gross weight, tare weight, net weight, stability, date, time etc., in the tamper-proof Alibi memory
- Output of the weighing result in all available units, in percent and a free factor
- Output of the weighing result in pieces (piece counting function)
- Output of the weighing value at freely definable intervals
- and much more

KCP – Import (“Inbound”) – the Highlights

- Recall of the central device data
- Setup or recall of an individual device ID number
- Setting or searching for a tare value (pre-tare value) externally
- Recall of stored weighing results from the alibi memory
- Setting the reference values in the balance for outputting the weighing result in percent or in pieces
- Setting a network address for the balance (IP) – also for WiFi
- and much more

3



PRECISION BALANCES

Here you'll find a complete summary of the KERN laboratory scales series and their positioning within the precision scales segment on the basis of application, price-performance ratio and functional volume

KERN Basic laboratory balances

are used in laboratory applications mostly as single-user balances for sample preparation, etc. They are fitted with all useful laboratory functions which will support the user in a helpful way. With their strain gauge measuring principle, they are used anywhere where individual weighings are carried out, such as, for example, checkweighing. These devices are often connected to printers or local PCs using the standard, integrated RS-232 data interface.

KERN Basic standard laboratory balances

offer you all the tools you would need for effective and accurate work in your laboratory environment. All important laboratory functions such as a recipe weighing function or data interfaces are on board at all times. But above all, the high-quality measuring principles of these balances such as force compensation or tuning fork measuring principle, allow them to be used in dosing procedures with very small weight changes and rapid display. In addition these balances are often fitted with automatic internal adjustment, which means the balance can be used in any location.

KERN premium laboratory balances

are right at the top of the precision balance segment. The numerous equipment features of the standard balances are complemented by high-quality materials with robust, sturdy construction, high-quality, high-performance weighing systems, optimised operating sequences, speed benefits.

Tip: Together with the innovative KERN EasyTouch app, a premium laboratory balance supports its users in their typical workflows and increases the range of functions of the balance. In this way these scales can be operated more efficiently and quickly than devices from other quality classes. In particular, these balances are used in demanding laboratory applications and anywhere where the environmental conditions are not ideal because of vibrations or other interference, but where, naturally, the balance is expected to provide accurate weighing results. Another field of application for these balances is the pharmaceutical industry, which is subject to particularly demanding requirements such as, for example, the GLP (Good Laboratory Practice).

If you have further questions on the subject of "Which balance is best for my application?", then please ask your personal KERN Category Manager who will be happy to help you.



Digital weighing data – with KERN EasyTouch

Discover KERN EasyTouch - innovative software, which combines the precision of our tried and tested KERN balances with the versatility of Windows or Android environments.

What benefits does KERN EasyTouch offer?

- Digital processing and saving of weighing data directly in the process
- Greater efficiency through streamlined workflows
- Increased safety for critical processes
- Unlimited master data memory
- Central, secure data storage (tamper-proof and traceable at any time)
- Interfaces to Excel, ERP, PPS and CRM systems

This is how KERN EasyTouch works:

1. Collection of weighing and measuring data using an appropriate measuring device
2. Transfer, saving and processing in relation to master data such as item data, order data, batch data and user data
3. Output or transfer of data to connected systems or peripheral devices

Tip: Turn your balance into a powerful weighing system!

Using the KERN EasyTouch App even a simple single balance can be made into a powerful weighing system, which offers a range of functions. To do this you simply have to install the KERN EasyTouch App on your PC or tablet (Windows® or Android™), connect the balance (either with cable or wireless), activate the App and you will be able to control your balance using your PC or tablet straightaway (see page 136).

This symbol will show you which balances are compatible with EasyTouch



Quick-finder Precision Balances

| Readability [d] g | Weighing capacity [Max] g | Model | Price excl. of VAT ex works € | Page |  For an explanation on the pictos, see the front flap | | | | | | | | | | | | | | | | |
|-------------------------|---------------------------------|-------------|--|------|--|---|--|--|--|--|--|--|--|--|--|--|--|--|--|--|--|
| | | | | | KERN | | | | | | | | | | | | | | | | |
| 0,001 | 120 | PFB 120-3 | 370,- | 25 | | | | | | | | | | | | | | | | | |
| 0,001 | 200 | PCB 200-3 | 310,- | 26 | | | | | | | | | | | | | | | | | |
| 0,001 | 200 | PFB 200-3 | 390,- | 25 | | | | | | | | | | | | | | | | | |
| 0,001 | 220 | EW 220-3NM | 840,- | 34 | | | | | | | | | | | | | | | | | |
| 0,001 | 220 | EG 220-3NM | 1060,- | 34 | ○ | ● | | | | | | | | | | | | | | | |
| 0,001 | 240 | 572-30 | 750,- | 31 | | | | | | | | | | | | | | | | | |
| 0,001 | 250 | PCD 250-3 | 350,- | 24 | | | | | | | | | | | | | | | | | |
| 0,001 | 300 | PFB 300-3 | 420,- | 25 | | | | | | | | | | | | | | | | | |
| 0,001 | 300 | EWJ 300-3 | 580,- | 30 | | | | | | | | | | | | | | | | | |
| 0,001 | 300 | EWJ 300-3H | 600,- | 30 | | | | | | | | | | | | | | | | | |
| 0,001 | 300 | 572-31 | 765,- | 31 | | | | | | | | | | | | | | | | | |
| 0,001 | 320 | PDS 300-3 | 1200,- | 38 | | | | | | | | | | | | | | | | | |
| 0,001 | 320 | PDT 300-3 | 1400,- | 38 | | | | | | | | | | | | | | | | | |
| 0,001 | 350 | PCD 300-3 | 390,- | 24 | | | | | | | | | | | | | | | | | |
| 0,001 | 360 | PCB 300-3 | 320,- | 26 | | | | | | | | | | | | | | | | | |
| 0,001 | 420 | 572-32 | 775,- | 31 | | | | | | | | | | | | | | | | | |
| 0,001 | 420 | PLS 420-3F | 860,- | 32 | | | | | | | | | | | | | | | | | |
| 0,001 | 420 | PLJ 420-3F | 960,- | 32 | | | | | | | | | | | | | | | | | |
| 0,001 | 420 | EW 420-3NM | 970,- | 34 | | | | | | | | | | | | | | | | | |
| 0,001 | 420 | EG 420-3NM | 1160,- | 34 | ○ | ● | | | | | | | | | | | | | | | |
| 0,001 | 600 | PFB 600-3 | 500,- | 25 | | | | | | | | | | | | | | | | | |
| 0,001 | 600 | EWJ 600-3 | 690,- | 30 | | | | | | | | | | | | | | | | | |
| 0,001 | 620 | PNS 600-3 | 820,- | 33 | | | | | | | | | | | | | | | | | |
| 0,001 | 620 | PNJ 600-3M | 950,- | 33 | ○ | ● | | | | | | | | | | | | | | | |
| 0,001 | 620 | EW 620-3NM | 1080,- | 34 | | | | | | | | | | | | | | | | | |
| 0,001 | 620 | EG 620-3NM | 1300,- | 34 | ○ | ● | | | | | | | | | | | | | | | |
| 0,001 | 620 | PES 620-3M | 1500,- | 36 | | | | | | | | | | | | | | | | | |
| 0,001 | 620 | PBS 620-3M | 1750,- | 37 | | | | | | | | | | | | | | | | | |
| 0,001 | 620 | PEJ 620-3M | 1800,- | 36 | ○ | ● | | | | | | | | | | | | | | | |
| 0,001 | 620 | PBJ 620-3M | 2050,- | 37 | ○ | ● | | | | | | | | | | | | | | | |
| 0,001 | 620 | PDS 600-3 | 1740,- | 38 | | | | | | | | | | | | | | | | | |
| 0,001 | 620 | PDT 600-3 | 1940,- | 38 | | | | | | | | | | | | | | | | | |
| 0,001 | 720 | PLS 720-3A | 1170,- | 32 | | | | | | | | | | | | | | | | | |
| 0,001 | 720 | PLJ 720-3A | 1280,- | 32 | | | | | | | | | | | | | | | | | |
| 0,001 | 1020 | PDS 1000-3 | 2100,- | 38 | | | | | | | | | | | | | | | | | |
| 0,001 | 1020 | PDT 1000-3 | 2300,- | 38 | | | | | | | | | | | | | | | | | |
| 0,001 | 1200 | PLS 1200-3A | 1200,- | 32 | | | | | | | | | | | | | | | | | |
| 0,001 | 1200 | PLJ 1200-3A | 1360,- | 32 | | | | | | | | | | | | | | | | | |
| 0,001 | 2100 | PLJ 2000-3A | 1880,- | 32 | | | | | | | | | | | | | | | | | |
| 0,01 | 300 | PCB 300-2 | 250,- | 26 | | | | | | | | | | | | | | | | | |
| 0,01 | 600 | PFB 600-2 | 320,- | 25 | | | | | | | | | | | | | | | | | |
| 0,01 | 600 | PCJ 600-2M | 420,- | 28 | ○ | ● | | | | | | | | | | | | | | | |
| 0,01 | 600 | EWJ 600-2SM | 470,- | 30 | ○ | ● | | | | | | | | | | | | | | | |
| 0,01 | 600 | EWJ 600-2M | 500,- | 30 | ○ | ● | | | | | | | | | | | | | | | |
| 0,01 | 820 | EW 820-2NM | 760,- | 34 | | | | | | | | | | | | | | | | | |
| 0,01 | 820 | PWS 800-2 | 1160,- | 35 | | | | | | | | | | | | | | | | | |
| 0,01 | 1200 | PFB 1200-2 | 320,- | 25 | | | | | | | | | | | | | | | | | |
| 0,01 | 1200 | PCB 1000-2 | 290,- | 26 | | | | | | | | | | | | | | | | | |
| 0,01 | 1600 | 572-33 | 735,- | 31 | | | | | | | | | | | | | | | | | |
| 0,01 | 2000 | PFB 2000-2 | 340,- | 25 | | | | | | | | | | | | | | | | | |
| 0,01 | 2200 | EW 2200-2NM | 930,- | 34 | | | | | | | | | | | | | | | | | |
| 0,01 | 2200 | PES 2200-2M | 1060,- | 36 | | | | | | | | | | | | | | | | | |
| 0,01 | 2200 | EG 2200-2NM | 1110,- | 34 | ○ | ● | | | | | | | | | | | | | | | |
| 0,01 | 2200 | PEJ 2200-2M | 1350,- | 36 | ○ | ● | | | | | | | | | | | | | | | |
| 0,01 | 2200 | PDS 2000-2 | 1300,- | 38 | | | | | | | | | | | | | | | | | |
| 0,01 | 2200 | PDT 2000-2 | 1500,- | 38 | | | | | | | | | | | | | | | | | |
| 0,01 | 2400 | 572-35 | 750,- | 31 | | | | | | | | | | | | | | | | | |
| 0,01 | 2500 | PCD 2500-2 | 350,- | 24 | | | | | | | | | | | | | | | | | |
| 0,01 | 3000 | PFB 3000-2 | 370,- | 25 | | | | | | | | | | | | | | | | | |
| 0,01 | 3000 | EWJ 3000-2 | 530,- | 30 | | | | | | | | | | | | | | | | | |
| 0,01 | 3000 | 572-37 | 765,- | 31 | | | | | | | | | | | | | | | | | |
| 0,01 | 3200 | PNS 3000-2 | 740,- | 33 | | | | | | | | | | | | | | | | | |
| 0,01 | 3200 | PNJ 3000-2M | 890,- | 33 | ○ | ● | | | | | | | | | | | | | | | |
| 0,01 | 3500 | PCD 3000-2 | 390,- | 24 | | | | | | | | | | | | | | | | | |
| 0,01 | 3600 | PCB 3000-2 | 310,- | 26 | | | | | | | | | | | | | | | | | |
| 0,01 | 4200 | 572-39 | 775,- | 31 | | | | | | | | | | | | | | | | | |
| 0,01 | 4200 | PLS 4200-2F | 820,- | 32 | | | | | | | | | | | | | | | | | |
| 0,01 | 4200 | PLJ 4200-2F | 930,- | 32 | | | | | | | | | | | | | | | | | |
| 0,01 | 4200 | EW 4200-2NM | 1030,- | 34 | | | | | | | | | | | | | | | | | |
| 0,01 | 4200 | EG 4200-2NM | 1220,- | 34 | ○ | ● | | | | | | | | | | | | | | | |
| 0,01 | 4200 | PES 4200-2M | 1250,- | 36 | | | | | | | | | | | | | | | | | |

Quick-finder Precision Balances

| Readability [d] g | Weighing capacity [Max] g | Model KERN | Price excl. of VAT ex works € | Page | | | | | | | | | | |
|-------------------------|---------------------------------|-------------------|--|------|---|---|--|---|--|--|--|--|--|---|
| 0,01 | 4200 | PBS 4200-2M | 1540,- | 37 | | | | | | | | | | |
| 0,01 | 4200 | PEJ 4200-2M | 1550,- | 36 | ○ | ● | | | | | | | | |
| 0,01 | 4200 | PBJ 4200-2M | 1900,- | 37 | ○ | ● | | | | | | | | |
| 0,01 | 4200 | PDS 4000-2 | 1500,- | 38 | | | | | | | | | | |
| 0,01 | 4200 | PDT 4000-2 | 1700,- | 38 | | ● | | | | | | | | |
| 0,01 | 6000 | PFB 6000-2 | 450,- | 25 | | | | | | | | | | |
| 0,01 | 6000 | EWJ 6000-2 | 640,- | 30 | | ● | | | | | | | | ○ |
| 0,01 | 6200 | EW 6200-2NM | 1120,- | 34 | | | | | | | | | | ○ |
| 0,01 | 6200 | PLS 6200-2A | 1150,- | 32 | | | | | | | | | | |
| 0,01 | 6200 | PLJ 6200-2A | 1280,- | 32 | | ● | | | | | | | | |
| 0,01 | 6200 | PES 6200-2M | 1550,- | 36 | | | | | | | | | | |
| 0,01 | 6200 | PBS 6200-2M | 1850,- | 37 | | | | | | | | | | |
| 0,01 | 6200 | PBJ 6200-2M | 2300,- | 37 | ○ | ● | | | | | | | | |
| 0,01 | 6200 | PDS 6000-2 | 1720,- | 38 | | | | | | | | | | |
| 0,01 | 6200 | PDT 6000-2 | 1920,- | 38 | | ● | | | | | | | | |
| 0,01 | 8200 | PLS 8000-2A | 1400,- | 32 | | | | | | | | | | |
| 0,05 | 12000 | 572-45 | 750,- | 31 | | | | ○ | | | | | | ○ |
| 0,05 | 20000 | 572-55 | 770,- | 31 | | | | | | | | | | ○ |
| 0,1 | 2000 | PCB 2000-1 | 230,- | 26 | | | | ○ | | | | | | ○ |
| 0,1 | 3200 | PWS 3000-1 | 1020,- | 35 | | | | | | | | | | ○ |
| 0,1 | 6000 | PCD 6K-4 | 270,- | 24 | | | | | | | | | | ○ |
| 0,1 | 6000 | PCB 6000-1 | 250,- | 26 | | | | ○ | | | | | | ○ |
| 0,1 | 6000 | PFB 6000-1 | 300,- | 25 | | | | | | | | | | ○ |
| 0,1 | 6000 | PCJ 6000-1M | 440,- | 28 | ○ | ● | | ○ | | | | | | ○ |
| 0,1 | 6000 | EWJ 6000-1SM | 450,- | 30 | ○ | ● | | | | | | | | ○ |
| 0,1 | 6000 | EWJ 6000-1M | 480,- | 30 | ○ | ● | | | | | | | | ○ |
| 0,1 | 8200 | PWS 8000-1 | 1150,- | 35 | | | | | | | | | | ○ |
| 0,1 | 8200 | PBJ 8200-1M | 1890,- | 37 | ○ | ● | | | | | | | | ○ |
| 0,1 | 10000 | PCD 10K0.1 | 290,- | 24 | | | | | | | | | | ○ |
| 0,1 | 10000 | PCB 10000-1 | 260,- | 26 | | | | ○ | | | | | | ○ |
| 0,1 | 10000 | 572-43 | 730,- | 31 | | | | | | | | | | ○ |
| 0,1 | 12000 | PNS 12000-1 | 720,- | 33 | | | | | | | | | | |
| 0,1 | 12000 | PNJ 12000-1M | 870,- | 33 | ○ | ● | | | | | | | | |
| 0,1 | 12000 | EW 12000-1NM | 880,- | 34 | | | | | | | | | | ○ |
| 0,1 | 15000 | PES 15000-1M | 1480,- | 36 | | | | | | | | | | |
| 0,1 | 16000 | 572-49 | 735,- | 31 | | | | ○ | | | | | | ○ |
| 0,1 | 17000 | FES 17K-4 | 2850,- | 40 | | | | | | | | | | ○ |
| 0,1 | 17000 | FEJ 17K-4M | 3080,- | 40 | ○ | ● | | | | | | | | ○ |
| 0,1 | 20000 | PLS 20000-1F | 750,- | 32 | | | | | | | | | | |
| 0,1 | 24000 | 572-57 | 760,- | 31 | | | | | | | | | | ○ |
| 0,1 | 31000 | PES 31000-1M | 2450,- | 36 | | | | | | | | | | |
| 0,1 | 33000 | FES 33K-4 | 3000,- | 40 | | | | | | | | | | ○ |
| 0,1 | 33000 | FEJ 33K-4M | 3340,- | 40 | ○ | ● | | | | | | | | ○ |
| 0,1 1 | 6200 62000 | FES 62K-4D | 3300,- | 40 | | | | | | | | | | ○ |
| 0,1 1 | 6200 62000 | FEJ 62K-4DM | 3650,- | 40 | ○ | ● | | | | | | | | ○ |
| 1 | 6000 | PCB 6000-0 | 170,- | 26 | | | | | | | | | | ○ |
| 1 | 10000 | PCD 10K-3 | 210,- | 24 | | | | | | | | | | ○ |

News 2025

● Standard ○ Option



For an explanation on the pictos, see the front flap

3



High-resolution precision balance with removable display for maximum flexibility

Features

- Laboratory balance with separate platform: Ideal when working in a glove bag or fume cupboard. Particularly practical for weighing toxic, volatile or contaminated substances
- PRE-TARE function for manual subtraction of a known container weight, useful for checking fill-levels
- Freely programmable weighing unit, e.g. display direct in special units such as length of thread g/m, paper weight g/m², or similar
- Level indicator and levelling feet for precise levelling of the scale, fitted as standard, to give the most accurate weighing result
- **A** Draught shield standard for models with weighing plate size **A**, weighing space W×D×H 146×146×80 mm
- Protective working cover included with delivery

Technical data

- Large backlit LCD display, digit height 21 mm
- Dimensions weighing surface
 - A** ø 105 mm, plastic, with conductive lacquer
 - B** W×D 160×160 mm, stainless steel, see larger picture
- Optional battery operation, 9 V block not included in scope of delivery, operating time up to 12 h, AUTO-OFF function to preserve the battery
- Dimensions of display device W×D×H 140×82×46 mm
- Cable length of display device approx. 1,2 m
- Net weight approx. 1,2 kg
- Permissible ambient temperature 5 °C/35 °C

Accessories

- Protective working cover over the display device, scope of delivery 5 items, KERN PCD-A05S05, **€ 52,-**
- **2** Stand to elevate display device, height of stand approx. 250 mm, KERN PCD-A03, **€ 66,-**
- Internal rechargeable battery pack, operating time up to 24 h without backlight, charging time approx. 10 h, KERN PCD-A04, **€ 60,-**
- **3** Foot switch, ideal when the application requires two free hands. TARE or PRINT function can be selected. Scope of delivery: foot switch, junction box, connection cable. For the PRINT function you will need the RS-232 interface cable, KERN YKF-01, **€ 100,-**
- Individual header data: the free software can be used to print 4 header lines on the printout when using printers 911-013 and YKN-01
- Further details, plenty of further accessories and suitable printers see *Accessories*

STANDARD



OPTION

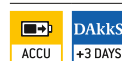

| Model | Weighing capacity [Max] | Readability [d] | Reproducibility | Linearity | Overall dimensions W×D×H mm | Weighing plate | Price excl. of VAT ex works € | Options | |
|-----------------|-------------------------|-----------------|-----------------|-----------|-----------------------------|----------------|-------------------------------|------------|-----------------------|
| | | | | | | | | DAKKS KERN | Calibr. Certificate € |
| KERN PCD 250-3 | 250 | 0,001 | 0,002 | ± 0,005 | 165×280×141 | A | 350,- | 963-127 | 103,- |
| KERN PCD 300-3 | 350 | 0,001 | 0,002 | ± 0,005 | 165×280×141 | A | 390,- | 963-127 | 103,- |
| KERN PCD 2500-2 | 2500 | 0,01 | 0,02 | ± 0,05 | 165×280×75 | B | 350,- | 963-127 | 103,- |
| KERN PCD 3000-2 | 3500 | 0,01 | 0,02 | ± 0,05 | 165×280×75 | B | 390,- | 963-127 | 103,- |
| KERN PCD 6K-4 | 6000 | 0,1 | 0,1 | ± 0,3 | 165×280×75 | B | 270,- | 963-128 | 124,- |
| KERN PCD 10K0.1 | 10000 | 0,1 | 0,1 | ± 0,3 | 165×280×75 | B | 290,- | 963-128 | 124,- |
| KERN PCD 10K-3 | 10000 | 1 | 1 | ± 3 | 165×280×75 | B | 210,- | 963-128 | 124,- |



Quick-display precision balance with user-friendly concept of operation mode – now also with checkweighing function

Features

- KERN PFB 600-3, PFB 6000-2: The measuring system's exceptionally high resolution of 600.000 points ensures the highest level of accuracy with large weighing ranges
- Weighing with tolerance range: a visual and audible signal helps with portioning, dispensing or grading
- Standardised, convenient KERN concept of operation: All primary functions have their own key on the keypad
- Compact size
- Capacity display: A bargraph display lights up to show how much of the weighing range is still available
- Level indicator and levelling feet for precise levelling of the scale, fitted as standard, to give the most accurate weighing result

- Draught shield standard for models with weighing plate size **A**, **B**, removable, weighing space W×D×H 140×150×65 mm

Technical data

- Backlit LCD display, digit height 21 mm
- Dimensions weighing surface, stainless steel
 - A** Ø 80 mm
 - B** Ø 120 mm
 - C** W×D 190×180 mm, see larger picture
- Overall dimensions W×D×H 210×315×90 mm
- Permissible ambient temperature 15 °C/30 °C

Accessories

- Protective working cover, scope of delivery 5 items, KERN PFB-A12S05, **€ 52,-**
- Internal rechargeable battery pack, operating time up to 72 h without backlight, charging time approx. 6,5 h, must be ordered at purchase, KERN EWJ-A06, **€ 45,-**
- Bluetooth data interface for wireless data transfer to PC or tablets, supports Bluetooth 2.0 and 4.0, must be ordered at purchase, KERN PFB-A10, **€ 100,-**
- Further details, plenty of further accessories and suitable printers see *Accessories*

STANDARD

| | | | | | | | | | | | | |
|---------|--------|-----|-----|-----|--------|---------|------|-----|------|-------|-----|-------|
| CAL EXT | RS 232 | KCP | GLP | PCS | RECIPE | PERCENT | UNIT | TOL | MOVE | MULTI | DMS | 1 DAY |
|---------|--------|-----|-----|-----|--------|---------|------|-----|------|-------|-----|-------|

OPTION

| | |
|-------|---------|
| DAkKS | +3 DAYS |
|-------|---------|

FACTORY

| | |
|----|------|
| BT | ACCU |
|----|------|

| Model | Weighing capacity [Max] | Readability [d] | Reproducibility | Linearity | Resolution | Weighing plate | Price excl. of VAT ex works € | Options | |
|-------------------|-------------------------|-----------------|-----------------|-----------|------------|----------------|-------------------------------|------------|-----------------------------|
| | | | | | | | | DAkKS KERN | DAkKS Calibr. Certificate € |
| PFB 120-3 | 120 | 0,001 | 0,002 | ± 0,003 | 120.000 | A | 370,- | 963-127 | 103,- |
| PFB 200-3 | 200 | 0,001 | 0,002 | ± 0,004 | 200.000 | A | 390,- | 963-127 | 103,- |
| PFB 300-3 | 300 | 0,001 | 0,003 | ± 0,005 | 300.000 | A | 420,- | 963-127 | 103,- |
| PFB 600-3 | 600 | 0,001 | 0,005 | ± 0,005 | 600.000 | B | 500,- | 963-103 | 170,- |
| PFB 600-2 | 600 | 0,01 | 0,01 | ± 0,02 | 60.000 | B | 320,- | 963-127 | 103,- |
| PFB 1200-2 | 1200 | 0,01 | 0,02 | ± 0,03 | 120.000 | B | 320,- | 963-127 | 103,- |
| PFB 2000-2 | 2000 | 0,01 | 0,02 | ± 0,04 | 200.000 | B | 340,- | 963-127 | 103,- |
| PFB 3000-2 | 3000 | 0,01 | 0,03 | ± 0,05 | 300.000 | B | 370,- | 963-127 | 103,- |
| PFB 6000-2 | 6000 | 0,01 | 0,05 | ± 0,07 | 600.000 | C | 450,- | 963-104 | 193,- |
| PFB 6000-1 | 6000 | 0,1 | 0,1 | ± 0,2 | 60.000 | C | 300,- | 963-128 | 124,- |



3



The standard in the laboratory, ideal for a wide range of applications for Industry 4.0

Features

- Compatible with school-specific software solutions such as, for example, Vernier® or LabQuest®. Thanks to the KERN School Protocol, as part of technical experiments, weighing data can be transferred to a PC, laptop, etc. for evaluation and display using the USB data interface
- KERN Universal Port (KUP): permits the connection of an external KUP interface adapter, such as, for example, RS-232, USB, Bluetooth, WiFi or Ethernet, for the exchange of data and control commands, without any installation outlay
- KERN Communication Protocol (KCP): The KCP permits searching and remote control of the balance using external control devices or computers
- For further information on KUP and KCP see page 18/19
- Standardised, simplified concept of operation
- PRE-TARE function for manual subtraction of a known container weight, useful for checking fill-levels
- With the recipe function you can weigh the different ingredients of a mixture. As a check, you can also call up the total weight of all the ingredients
- Weighing with tolerance range: a visual and audible signal helps with portioning, dispensing or grading
- Freely programmable weighing unit, e.g. display direct in special units such as length of thread g/m, paper weight g/m², or similar
- A special Anti-Shock system between the weighing plate and weighing cell reduces vibrations during the weighing process and in this way ensures rapid, reliable weighing results
- **A** Ring-shaped draught shield standard, only for models with weighing plate size **A**, weighing space $\varnothing \times H$ 90×40 mm
- Protective working cover included with delivery



Technical data

- Backlit LCD display, digit height 21 mm
- Dimensions weighing surface
 - A** ϕ 82 mm
 - B** ϕ 105 mm
 - C** WxD 130x130 mm
 - D** WxD 150x170 mm, see larger picture
- Weighing plate material
 - A** plastic, with conductive lacquer
 - B, C, D** stainless steel
- Overall dimensions (without draught shield) WxDxH 163x245x65 mm
- Optional battery operation, 4x1.5 V AA not included in scope of delivery, operating time up to 20 h. AUTO-OFF function to preserve the battery
- Permissible ambient temperature -10 °C/40 °C

Accessories

- Protective working cover, scope of delivery 5 items, KERN YBA-A12S05, **€ 52,-**
- Internal rechargeable battery pack, operating time up to 48 h without backlight, charging time approx. 8 h, KERN YKR-01, **€ 35,-**
- RS-232 interface adapter, KERN KUP-01, **€ 60,-**
- USB interface adapter, KERN KUP-03, **€ 75,-**
- Ethernet interface adapter, KERN KUP-04, **€ 115,-**
- WiFi interface adapter, KERN KUP-05, **€ 75,-**
- Bluetooth interface adapter, KERN KUP-06, **€ 99,-**
- Extension box for connecting up to three interfaces in parallel, KERN KUP-13, **€ 75,-**
- BalanceConnection software for flexible measured value recording or transmission, compatible with Microsoft® Excel, Access and other applications, Scope of supplies: Download link for 1 license, KERN SCD-4.0-DL, **€ 210,-**
- Further details, plenty of further accessories and suitable printers see *Accessories*

STANDARD



OPTION



| Model | Weighing capacity [Max] | Readability [d] | Reproducibility | Linearity | Resolution | Weighing plate | Price excl. of VAT ex works € | Options | |
|-------------------------|-------------------------|-----------------|-----------------|-----------|------------|----------------|-------------------------------|------------|-----------------------------|
| | | | | | | | | DAKkS KERN | DAKkS Calibr. Certificate € |
| KERN PCB 200-3 | 200 | 0,001 | 0,001 | ± 0,005 | 200.000 | A | 310,- | 963-127 | 103,- |
| KERN PCB 300-3 | 360 | 0,001 | 0,001 | ± 0,005 | 360.000 | A | 320,- | 963-127 | 103,- |
| KERN PCB 300-2 | 300 | 0,01 | 0,01 | ± 0,02 | 30.000 | B | 250,- | 963-127 | 103,- |
| KERN PCB 1000-2 | 1200 | 0,01 | 0,01 | ± 0,03 | 120.000 | C | 290,- | 963-127 | 103,- |
| KERN PCB 3000-2 | 3600 | 0,01 | 0,02 | ± 0,05 | 360.000 | C | 310,- | 963-127 | 103,- |
| KERN PCB 2000-1 | 2000 | 0,1 | 0,1 | ± 0,2 | 20.000 | C | 230,- | 963-127 | 103,- |
| KERN PCB 6000-1 | 6000 | 0,1 | 0,1 | ± 0,3 | 60.000 | D | 250,- | 963-128 | 124,- |
| KERN PCB 10000-1 | 10000 | 0,1 | 0,1 | ± 0,3 | 100.000 | D | 260,- | 963-128 | 124,- |
| KERN PCB 6000-0 | 6000 | 1 | 1 | ± 2 | 6.000 | D | 170,- | 963-128 | 124,- |



PCJ 600-2M

PCJ 6000-1M



Precision balance with alibi memory and optional verification



Internal adjustment using the rotary control on the side guarantees a high degree of accuracy and means it can be used in any location

Features

- With alibi memory for paperless archiving of weighing results. This also means the results of weighings with mandatory verification can be electronically evaluated and processed further
- The balance can be adjusted in battery operation without the need for mains power
- Standardised, convenient KERN concept of operation, consistency across products in terms of design, menu structure, button functions, interface connection and interface protocol
- Menu with a large number of settings which can be adapted to your requirements. For example, you can specify button tones, assign a button with different functions for rapid access and adapt the print protocol as necessary
- Menu block prevents access by unauthorised users
- Ideal for connection to laboratory information systems (LIMS)
- GLP/ISO record keeping of weighing data, balance adjustment, etc. with date, time and identification number
- KERN Universal Port (KUP): permits the connection of an external KUP interface adapter, such as, for example, RS-232, USB, Bluetooth, WiFi or Ethernet, for the exchange of data and control commands, without any installation outlay
- KERN Communication Protocol (KCP): The KCP permits searching and remote control of the balance using external control devices or computers
- For further information on KUP and KCP see page 18/19
- Hook for underfloor weighing included with the delivery
- Protective working cover included with delivery

Technical data

- Backlit LCD display, digit height 21 mm
- Dimensions weighing surface, stainless steel
 - A** WxD 131x131 mm
 - B** WxD 150x170 mm
- Overall dimensions WxDxH 163x245x80 mm
- Battery operation, 4x1.5 V AA standard, operating time up to 20 h
- Permissible ambient temperature 15 °C/35 °C

Accessories

- Protective working cover, scope of delivery 5 items, KERN YBA-A12S05, **€ 52,-**
- Internal rechargeable battery pack, operating time up to 48 h without backlight, charging time approx. 8 h, KERN YKR-01, **€ 35,-**
- External universal mains adapter, with universal input and optional input socket adapters for EU, CH, GB, US, KERN YKA-24, **€ 43,-**
- RS-232 interface adapter, KERN KUP-01, **€ 60,-**
- USB interface adapter, KERN KUP-03, **€ 75,-**
- Ethernet interface adapter, KERN KUP-04, **€ 115,-**
- WiFi interface adapter, KERN KUP-05, **€ 75,-**
- Bluetooth interface adapter, KERN KUP-06, **€ 99,-**
- Extension box for connecting up to three interfaces in parallel, KERN KUP-13, **€ 75,-**
- BalanceConnection software for flexible measured value recording or transmission, compatible with Microsoft® Excel, Access and other applications, Scope of supplies: Download link for 1 license, KERN SCD-4.0-DL, **€ 210,-**
- Further details, plenty of further accessories and suitable printers see *Accessories*

The main scope of applications is:

- Laboratories
- Chemists
- Jewellers
- Pharmaceutical industry

STANDARD

OPTION

FACTORY

| Model | Weighing capacity [Max] | Readability [d] | Verification value [e] | Minimal load [Min] | Linearity | Weighing plate | Net weight | Price excl. of VAT ex works € | Options | | | |
|------------------|-------------------------|-----------------|------------------------|--------------------|-----------|----------------|------------|-------------------------------|--------------|------|---------------------------|-------|
| | | | | | | | | | Verification | € | DAkKS Calibr. Certificate | € |
| KERN PCJ 600-2M | 600 | 0,01 | 0,1 | 0,5 | ± 0,03 | A | 2,0 | 420,- | 965-216 | 85,- | 963-127 | 103,- |
| KERN PCJ 6000-1M | 6000 | 0,1 | 1 | 5 | ± 0,3 | B | 2,8 | 440,- | 965-217 | 99,- | 963-128 | 124,- |

Note: For devices that require verification (conformity assessment according to NAWI 2014/31/EU), please include the verification when placing your order. The initial verification is not possible after delivery. Please inform the full address of the location of use for the initial verification.



High-quality precision balance with automatic internal adjustment, verification optional

Features

- EWJ 600-3/EWJ 6000-2: The measuring system's exceptionally high resolution of 600.000 points ensures the highest level of accuracy with large weighing ranges
- Weighing with tolerance range: a visual and audible signal helps with portioning, dispensing or grading
- Standardised, convenient KERN concept of operation: All primary functions have their own key on the keypad
- Automatic internal adjustment, time-controlled every 2 h, guarantees high degree of accuracy and makes the balance independent of its location

- Capacity display: A bargraph display lights up to show how much of the weighing range is still available
- KERN EWJ/-H/-M: USB data interface for transferring weighing data to the PC, printer etc.
- Small draught shield as standard for models with weighing plate size **A**, **B**, removable, weighing space W×D×H 134×128×80 mm
- 1** KERN EWJ 300-3H: Large glass draught shield with 3 sliding doors for easy access to the items being weighed. Weighing space W×D×H 155×175×217 mm
- Protective working cover included with delivery



Technical data

- Large LCD display, digit height 21 mm
- Dimensions weighing surface, stainless steel
 - A** ø 80 mm
 - B** ø 120 mm
 - C** ø 135 mm, see larger picture
 - D** W×D 155×145 mm
- Permissible ambient temperature
 - KERN EWJ: 10 °C/35 °C
 - KERN EWJ-M: 10 °C/35 °C

Accessories

- Protective working cover, scope of delivery 5 items, KERN EWJ-A04S05, **€ 52,-**
- Internal rechargeable battery pack, operating time up to 57 h without backlight, charging time approx. 6,5 h, KERN EWJ-A06, **€ 45,-**
- Bluetooth data interface for wireless data transfer to PC or tablets, supports Bluetooth 2.0 and 4.0, must be ordered at purchase, KERN PFB-A10, **€ 100,-**
- KERN EWJ/-H/-M: BalanceConnection software for flexible measured value recording or transmission, compatible with Microsoft® Excel, Access and other applications, Scope of supplies: Download link for 1 license, KERN SCD-4.0-DL, **€ 210,-**
- Further details, plenty of further accessories and suitable printers see *Accessories*

STANDARD

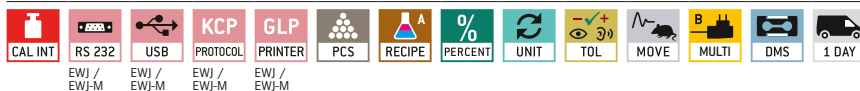

OPTION



FACTORY

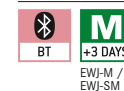

| Model | Weighing capacity [Max] g | Readability [d] g | Verification value [e] g | Minimal load [Min] g | Linearity g | Overall dimensions W×D×H mm | Weighing plate | Price excl. of VAT ex works € | Options | | | |
|---|---------------------------|-------------------|--------------------------|----------------------|-------------|-----------------------------|----------------|-------------------------------|--------------|------|---------|---------------------|
| | | | | | | | | | Verification | € | DAkKS | Calibr. Certificate |
| KERN EWJ 300-3H | 300 | 0,001 | - | - | ± 0,005 | 220×340×321 | A | 600,- | - | - | 963-127 | 103,- |
| KERN EWJ 300-3 | 300 | 0,001 | - | - | ± 0,005 | 220×340×90 | A | 580,- | - | - | 963-127 | 103,- |
| KERN EWJ 600-3 | 600 | 0,001 | - | - | ± 0,005 | 220×340×105 | B | 690,- | - | - | 963-103 | 170,- |
| KERN EWJ 3000-2 | 3000 | 0,01 | - | - | ± 0,05 | 220×340×105 | C | 530,- | - | - | 963-127 | 103,- |
| KERN EWJ 6000-2 | 6000 | 0,01 | - | - | ± 0,05 | 220×340×105 | D | 640,- | - | - | 963-104 | 193,- |
| Note: For devices that require verification (conformity assessment according to NAWI 2014/31/EU), please include the verification when placing your order. The initial verification is not possible after delivery. Please inform the full address of the location of use for the initial verification. | | | | | | | | | | | | |
| KERN EWJ 600-2M | 600 | 0,01 | 0,1 | 0,5 | ± 0,03 | 220×340×90 | B | 500,- | 965-216 | 85,- | 963-127 | 103,- |
| KERN EWJ 6000-1M | 6000 | 0,1 | 1 | 5 | ± 0,3 | 220×340×105 | D | 480,- | 965-217 | 99,- | 963-128 | 124,- |
| Variants without data interfaces | | | | | | | | | | | | |
| KERN EWJ 600-2SM | 600 | 0,01 | 0,1 | 0,5 | ± 0,03 | 220×340×90 | B | 470,- | 965-216 | 85,- | 963-127 | 103,- |
| KERN EWJ 6000-1SM | 6000 | 0,1 | 1 | 5 | ± 0,3 | 220×340×105 | D | 450,- | 965-217 | 99,- | 963-128 | 124,- |



All-rounder, e.g. as precision balance in the laboratory or in harsh industrial applications, ideal for the diverse possibilities of Industry 4.0 applications

Features

- Thanks to the many typical laboratory functions combined with the high level of precision, the KERN 572 is a reliable partner for day-to-day work in the laboratory
- Many typical industrial functions, such as piece-counting and vibrationfree weighing also make these balances ideal for all industrial applications, where a high level of precision is required
- KERN Universal Port (KUP): permits the connection of an external KUP interface adapter, such as, for example, RS-232, USB, Bluetooth, WiFi or Ethernet, for the exchange of data and control commands, without any installation outlay

- KERN Communication Protocol (KCP): The KCP permits searching and remote control of the balance using external control devices or computers
- For further information on KUP and KCP see page 18/19
- Standardised, simplified concept of operation
- Freely programmable weighing unit, e.g. display direct in special units such as length of thread g/m, paper weight g/m², or similar
- The robust aluminium diecast housing maintains the stability, protects the weighing technology elements and is robust enough to cope with everyday use

STANDARD



OPTION



FACTORY



- **A** Ring-shaped draught shield standard, only for models with weighing plate size **A**, weighing space $\varnothing \times H$ 157×43 mm
- Level indicator to level the balance precisely
- Load support on the underside of the balance for models. Loop for underfloor weighing, standard for models with weighing plate size **A**
- Protective working cover included with delivery

Technical data

- Large backlit LCD display, digit height 21 mm
- Dimensions weighing surface, stainless steel
A \varnothing 106 mm
B \varnothing 150 mm
C W×D 160×200 mm, see larger picture
- Overall dimensions W×D×H 180×310×85 mm
- Net weight **A**, **B** approx. 2,4 kg **C** approx. 2,8 kg
- Permissible ambient temperature -10 °C/40 °C

Accessories

- Protective working cover, scope of delivery 5 items, KERN 572-A02S05, **€ 52,-**
- Internal rechargeable battery pack, operating time up to 48 h without backlight, charging time approx. 8 h, KERN YKR-01, **€ 35,-**
- Interface adapter, RS-232, KERN KUP-01, **€ 60,-**
USB, KERN KUP-03, **€ 75,-**
Ethernet, KERN KUP-04, **€ 115,-**
WiFi, KERN KUP-05, **€ 75,-**
Bluetooth, KERN KUP-06, **€ 99,-**
- Extension box for connecting up to three interfaces in parallel, KERN KUP-13, **€ 75,-**
- **B**, **C** Hook for underfloor weighing, KERN 572-A03, **€ 25,-**
- Large glass draught shield with 3 sliding doors for easy access to the items being weighed for models with weighing plate size **A**, weighing space W×D×H 150×140×130 mm, KERN 572-A05, **€ 250,-**

| Model | Weighing capacity [Max] | Readability [d] | Reproducibility | Linearity | Resolution | Weighing plate | Price excl. of VAT ex works € | Options | |
|--------|-------------------------|-----------------|-----------------|-----------|------------|----------------|-------------------------------|---------|---------------------|
| | | | | | | | | DAkKS | Calibr. Certificate |
| KERN | g | g | g | g | Points | | € | KERN | € |
| 572-30 | 240 | 0,001 | 0,001 | ± 0,003 | 240.000 | A | 750,- | 963-127 | 103,- |
| 572-31 | 300 | 0,001 | 0,002 | ± 0,005 | 300.000 | A | 765,- | 963-127 | 103,- |
| 572-32 | 420 | 0,001 | 0,002 | ± 0,005 | 420.000 | A | 775,- | 963-127 | 103,- |
| 572-33 | 1600 | 0,01 | 0,01 | ± 0,03 | 160.000 | B | 735,- | 963-127 | 103,- |
| 572-35 | 2400 | 0,01 | 0,01 | ± 0,03 | 240.000 | B | 750,- | 963-127 | 103,- |
| 572-37 | 3000 | 0,01 | 0,02 | ± 0,05 | 300.000 | B | 765,- | 963-127 | 103,- |
| 572-39 | 4200 | 0,01 | 0,02 | ± 0,05 | 420.000 | B | 775,- | 963-127 | 103,- |
| 572-45 | 12000 | 0,05 | 0,05 | ± 0,15 | 240.000 | C | 750,- | 963-128 | 124,- |
| 572-55 | 20000 | 0,05 | 0,1 | ± 0,25 | 400.000 | C | 770,- | 963-128 | 124,- |
| 572-43 | 10000 | 0,1 | 0,1 | ± 0,3 | 100.000 | C | 730,- | 963-128 | 124,- |
| 572-49 | 16000 | 0,1 | 0,1 | ± 0,3 | 160.000 | C | 735,- | 963-128 | 124,- |
| 572-57 | 24000 | 0,1 | 0,1 | ± 0,3 | 240.000 | C | 760,- | 963-128 | 124,- |



3



High-quality precision scale with comfortable graphic display and enormous weighing range

Features

- **1** Convenient recipe-weighing with the recipe database, up to 99 recipes can be stored, each with up to 20 recipe ingredients with name and target value
- Internal memory for complete recipes with name and target value of the recipe ingredients
- Dosage aid: High stability mode and other filter settings can be selected
- Rapid and efficient operation thanks to the graphics display
- Simple, clear user interface on the display in the following languages: DE, EN, FR, IT, ES, PT

- KERN PLJ: Automatic internal adjustment, guarantees high degree of accuracy and makes the balance independent of its location of use. Ideal for applications which require verification
- **2** KERN PLJ 2000-3A: High-quality milligram balance with enormous weighing range up to 2100 g – ideal for large samples or heavy tare containers. Large glass draught shield for easy access to the items being weighed. Weighing space W×D×H 160×170×225 mm
- **A** Ring-shaped draught shield standard, only for models with weighing plate size **A**, weighing space $\phi \times H$ 150×60 mm
- Protective working cover included with delivery

Technical data

- Backlit LCD graphic display, digit height 15 mm
- Dimensions weighing surface, stainless steel
 - A** ϕ 110 mm
 - B** ϕ 160 mm, see larger picture
 - C** W×D 200×175 mm
- Permissible ambient temperature 15 °C/35 °C

Accessories

- Protective working cover, scope of delivery 5 items, KERN PLJ-A01S05, **€ 52,-**
- **3** Hook for underfloor weighing, KERN PLJ-A02, **€ 32,-**
- Set for density determination of liquids and solids for models with [d] = 0,001 g, KERN ALT-A02, **€ 750,-**
- Minimum weight of sample, depending on the required process accuracy, only in combination with a DAkkS calibration certificate, KERN 969-103, **€ 10,-**
- Equipment qualification: compliant qualification concept with Installation and Operating Qualification (IQ, OQ), for details see page 222

STANDARD



OPTION



FACTORY



| Model | Weighing capacity [Max] g | Readability [d] g | Reproducibility g | Linearity g | Overall dimensions W×D×H mm | Net weight kg | Weighing plate | Price excl. of VAT ex works € | Options | |
|---------------------------------|---------------------------|-------------------|-------------------|-------------|-----------------------------|---------------|----------------|-------------------------------|------------|-----------------------|
| | | | | | | | | | DAkkS KERN | Calibr. Certificate € |
| Models with external adjustment | | | | | | | | | | |
| PLS 420-3F | 420 | 0,001 | 0,001 | ± 0,004 | 210×340×160 | 3,2 | A | 860,- | 963-127 | 103,- |
| PLS 720-3A | 720 | 0,001 | 0,001 | ± 0,002 | 210×340×160 | 4,8 | A | 1170,- | 963-103 | 170,- |
| PLS 1200-3A | 1200 | 0,001 | 0,001 | ± 0,003 | 210×340×160 | 4,8 | A | 1200,- | 963-103 | 170,- |
| PLS 4200-2F | 4200 | 0,01 | 0,01 | ± 0,04 | 210×340×120 | 3,2 | B | 820,- | 963-127 | 103,- |
| PLS 6200-2A | 6200 | 0,01 | 0,01 | ± 0,03 | 210×340×120 | 4,8 | B | 1150,- | 963-104 | 193,- |
| PLS 8000-2A | 8200 | 0,01 | 0,01 | ± 0,04 | 210×340×120 | 4,8 | B | 1400,- | 963-104 | 193,- |
| PLS 20000-1F | 20000 | 0,1 | 0,1 | ± 0,4 | 210×340×120 | 3,2 | C | 750,- | 963-128 | 124,- |
| Models with internal adjustment | | | | | | | | | | |
| PLJ 420-3F | 420 | 0,001 | 0,001 | ± 0,003 | 210×340×160 | 5,0 | A | 960,- | 963-127 | 103,- |
| PLJ 720-3A | 720 | 0,001 | 0,001 | ± 0,002 | 210×340×160 | 5,0 | A | 1280,- | 963-103 | 170,- |
| PLJ 1200-3A | 1200 | 0,001 | 0,001 | ± 0,003 | 210×340×160 | 5,0 | A | 1360,- | 963-103 | 170,- |
| PLJ 2000-3A | 2100 | 0,001 | 0,002 | ± 0,004 | 210×340×330 | 7 | A | 1880,- | 963-103 | 170,- |
| PLJ 4200-2F | 4200 | 0,01 | 0,02 | ± 0,04 | 210×340×120 | 5,0 | B | 930,- | 963-127 | 103,- |
| PLJ 6200-2A | 6200 | 0,01 | 0,01 | ± 0,05 | 210×340×120 | 5,0 | B | 1280,- | 963-104 | 193,- |



The new standard in the laboratory with robust tuning fork weighing system, with optional verification

Features

- KERN PNS: Adjusting program CAL for quick setting of the balance accuracy, external test weights at an additional price, see test weights
- KERN PNJ; Automatic internal adjustment, guarantees high degree of accuracy and makes the balance independent of its location of use. Ideal for applications which require verification
- High-quality tuning fork weighing system for rapid display of the weight, very precise dispensing and a high level of mechanical robustness
- Capacity display: A bargraph display lights up to show how much of the weighing range is still available
- The automatic reference weight optimisation of reference weight gradually improves the average piece weight value
- Compact size
- Large, shock proof weighing plate made of stainless steel

- **A** Large glass draught shield with 3 sliding doors for easy access to the items being weighed: for models with weighing plate size **A**, weighing space W×D×H 172×171×160 mm
- Protective working cover included with delivery

Technical data

- Large LCD display, digit height 16,5 mm
- Dimensions weighing surface, stainless steel
 - A** ø 140 mm
 - B** W×D 190×190 mm, see larger picture
- Overall dimensions W×D×H
 - A** 196×293×266 mm
 - B** 196×293×89 mm
- Permissible ambient temperature 5 °C/40 °C

Accessories

- Protective working cover, scope of delivery 5 items, KERN PNJ-A01S05, **€ 52,-**
- **T** Gemstones plate, aluminium with practical spout, W×D×H 130×80×30 mm, KERN AEJ-A05, **€ 43,-**
- Minimum weight of sample, depending on the required process accuracy, only in combination with a DAkkS calibration certificate, KERN 969-103, **€ 10,-**
- Equipment qualification: compliant qualification concept with Installation and Operating Qualification (IQ, OQ), for details see page 222
- Further details, plenty of further accessories and suitable printers see *Accessories*

STANDARD OPTION FACTORY

| | | | | | | | | | | | | |
|---------|---------|--------|-----|----|---------|------|-----|-------|--------|-------|---------|-----|
| | | | | | | | | | | | | |
| CAL INT | CAL EXT | RS 232 | GLP | PC | PERCENT | UNIT | TOL | MULTI | T-FORK | 1 DAY | DAkkS | M |
| PNJ | PNS | | | | | | | | | | +3 DAYS | PNJ |

| Model | Weighing capacity [Max] | Readability [d] | Verification value [e] | Minimal load [Min] | Linearity | Weighing plate | Net weight | Price excl. of VAT ex works | Options | | | |
|---|-------------------------|-----------------|------------------------|--------------------|-----------|----------------|------------|-----------------------------|--------------|------|---------------------------|-------|
| | | | | | | | | | Verification | € | DAkkS Calibr. Certificate | € |
| KERN | g | g | g | g | g | kg | kg | € | | € | DAkkS KERN | € |
| PNS 600-3 | 620 | 0,001 | - | - | ± 0,004 | A | 2,2 | 820,- | - | - | 963-103 | 170,- |
| PNS 3000-2 | 3200 | 0,01 | - | - | ± 0,02 | B | 2,8 | 740,- | - | - | 963-127 | 103,- |
| PNS 12000-1 | 12000 | 0,1 | - | - | ± 0,2 | B | 2,8 | 720,- | - | - | 963-128 | 124,- |
| Note: For devices that require verification (conformity assessment according to NAWI 2014/31/EU), please include the verification when placing your order. The initial verification is not possible after delivery. Please inform the full address of the location of use for the initial verification. | | | | | | | | | | | | |
| PNJ 600-3M | 620 | 0,001 | 0,01 | 0,02 | ± 0,004 | A | 4,2 | 950,- | 965-216 | 85,- | 963-103 | 170,- |
| PNJ 3000-2M | 3200 | 0,01 | 0,1 | 0,5 | ± 0,02 | B | 3,6 | 890,- | 965-216 | 85,- | 963-127 | 103,- |
| PNJ 12000-1M | 12000 | 0,1 | 1 | 5 | ± 0,2 | B | 3,8 | 870,- | 965-217 | 99,- | 963-128 | 124,- |



The classic balance with robust tuning fork measuring system

Features

- **1** KERN EG: Internal adjustment in the case of a change in temperature and time-controlled at defined intervals, guarantees high degree of accuracy and makes the balance independent of its location of use
- Stable temperature behaviour
- Short stabilisation time
- Shock proof construction
- High corner load performance
- Capacity display: A bargraph display lights up to show how much of the weighing range is still available
- Totalising of pieces when counting

- **A** Draught shield standard for models with weighing plate size **A**, weighing space W×D×H 158×130×78 mm
- Protective working cover included with delivery

Technical data

- Large LCD display, digit height 17 mm
- Dimensions weighing surface, stainless steel
 - A** Ø 118 mm, see larger picture
 - B** W×D 170×140 mm
 - C** W×D 180×160 mm
- Overall dimensions W×D×H
 - A** 185×235×165 mm
 - B, C** 180×235×75 mm
- Permissible ambient temperature 10 °C/30 °C



Accessories

- Protective working cover, scope of delivery 5 items, for models with weighing plate size
 - A, B** KERN EG-A05S05, € 52,-
 - C** KERN EG-A09S05, € 52,-
- Internal rechargeable battery pack, operating time up to 12 h with backlight, charging time approx. 12 h, for models with weighing plate size
 - A, B** KERN EG-A04, € 130,-
 - C** KERN EG-A06, € 130,-
- **2** Large glass draught shield with 3 sliding doors for easy access to the items being weighed. Weighing space W×D×H 150×140×130 mm, KERN EG-A03, € 260,-
- Loop for underfloor weighing, for models with weighing plate size
 - A, B** KERN EG-A07, € 46,-
 - C** KERN EG-A08, € 46,-
- Minimum weight of sample, depending on the required process accuracy, only in combination with a DAkkS calibration certificate, KERN 969-103, € 10,-
- Equipment qualification: compliant qualification concept with Installation and Operating Qualification (IQ, OQ), for details see page 222
- Further details, plenty of further accessories and suitable printers see *Accessories*

STANDARD



OPTION



FACTORY



| Model | Weighing capacity [Max] g | Readability [d] g | Verification value [e] g | Minimal load [Min] g | Linearity g | Weighing plate | Net weight kg | Price excl. of VAT ex works € | Options | | | |
|------------------------|---------------------------|-------------------|--------------------------|----------------------|-------------|----------------|---------------|-------------------------------|---------------------|---|--------------------------------|-------|
| | | | | | | | | | Verification M KERN | € | DAkkS Calibr. Certificate KERN | € |
| KERN EW 220-3NM | 220 | 0,001 | - | - | ± 0,002 | A | 1,4 | 840,- | - | - | 963-127 | 103,- |
| EW 420-3NM | 420 | 0,001 | - | - | ± 0,003 | A | 1,4 | 970,- | - | - | 963-127 | 103,- |
| EW 620-3NM | 620 | 0,001 | - | - | ± 0,003 | A | 1,4 | 1080,- | - | - | 963-103 | 170,- |
| EW 820-2NM | 820 | 0,01 | - | - | ± 0,01 | B | 1,6 | 760,- | - | - | 963-127 | 103,- |
| EW 2200-2NM | 2200 | 0,01 | - | - | ± 0,01 | C | 3,0 | 930,- | - | - | 963-127 | 103,- |
| EW 4200-2NM | 4200 | 0,01 | - | - | ± 0,02 | C | 3,0 | 1030,- | - | - | 963-127 | 103,- |
| EW 6200-2NM | 6200 | 0,01 | - | - | ± 0,03 | C | 3,0 | 1120,- | - | - | 963-104 | 193,- |
| EW 12000-1NM | 12000 | 0,1 | - | - | ± 0,2 | C | 3,0 | 880,- | - | - | 963-128 | 124,- |

Note: For devices that require verification (conformity assessment according to NAWI 2014/31/EU), please include the verification when placing your order.

The initial verification is not possible after delivery. Please inform the full address of the location of use for the initial verification.

| | | | | | | | | | | | | |
|--------------------|------|-------|------|------|---------|----------|-----|---------------|---------|-------|---------|-------|
| EG 220-3NM | 220 | 0,001 | 0,01 | 0,02 | ± 0,002 | A | 2,0 | 1060,- | 965-216 | 85,- | 963-127 | 103,- |
| EG 420-3NM | 420 | 0,001 | 0,01 | 0,02 | ± 0,003 | A | 1,8 | 1160,- | 965-216 | 85,- | 963-127 | 103,- |
| EG 620-3NM | 620 | 0,001 | 0,01 | 0,1 | ± 0,004 | A | 2,0 | 1300,- | 965-201 | 150,- | 963-103 | 170,- |
| EG 2200-2NM | 2200 | 0,01 | 0,1 | 0,5 | ± 0,01 | C | 4,0 | 1110,- | 965-216 | 85,- | 963-127 | 103,- |
| EG 4200-2NM | 4200 | 0,01 | 0,1 | 0,5 | ± 0,02 | C | 4,0 | 1220,- | 965-216 | 85,- | 963-127 | 103,- |



High-resolution precision balance made of stainless steel with IP protection

Features

- High-quality tuning fork weighing system for rapid display of the weight, very precise dispensing and a high level of mechanical robustness
- Thanks to the stainless steel design of the housing and platform with smooth surface, the scale is rust-free and easy to clean
- IP65 dust and spray protection (in accordance with EN 60529)
- Level indicator and levelling feet for precise levelling of the scale, fitted as standard
- **1** RS-232 data interface for connection to a printer as standard

Technical data

- Large LCD display, digit height 16,5 mm
- Dimensions weighing surface, stainless steel
 - A** ø 140 mm
 - B** WxD 190x190 mm, see larger picture
- Overall dimensions WxDxH 320x205x90 mm
- Net weight approx. 3,0 kg
- Permissible ambient temperature 10 °C/30 °C

Accessories

- Loop for underfloor weighing, KERN EG-A07, **€ 46,-**
- BalanceConnection software for flexible measured value recording or transmission, compatible with Microsoft® Excel, Access and other applications, scope of supplies: Download link for 1 license, KERN SCD-4.0-DL, **€ 210,-**
- **2** Battery insert, enables mobile weighing, 4x1.5 V AA batteries (not included in delivery), Operating time 200 h, KERN PWS-A01, **€ 118,-**
- **3** Interface cable RS-232 to connect an external device, IP65 dust and spray protection (in accordance with EN 60529), KERN PWS-A02, **€ 300,-**
- Further details, plenty of further accessories and suitable printers see *Accessories*



3

| | | | | | | | | | | | | |
|----------|--------|---------|-----|---------|-----|-------|-------|--------|-------|--------|------|---------|
| STANDARD | | | | | | | | | | OPTION | | |
| | | | | | | | | | | | | |
| CAL EXT | RS 232 | PRINTER | PCS | PERCENT | TOL | IP 65 | MULTI | T-FORK | 1 DAY | UNDER | BATT | +3 DAYS |

| Model | Weighing capacity [Max] g | Readability [d] g | Reproducibility g | Linearity g | Weighing plate | Price excl. of VAT ex works € | Options | |
|-------------------|---------------------------------|-------------------------|----------------------|----------------|----------------|--|---------------|--------------------------|
| | | | | | | | DAkKS KERN | Calibr. Certificate € |
| PWS 800-2 | 820 | 0,01 | 0,01 | ± 0,01 | A | 1160,- | 963-127 | 103,- |
| PWS 3000-1 | 3200 | 0,1 | 0,1 | ± 0,1 | B | 1020,- | 963-127 | 103,- |
| PWS 8000-1 | 8200 | 0,1 | 0,1 | ± 0,1 | B | 1150,- | 963-128 | 124,- |



Robust laboratory and industrial precision scale for heavy items, verification optional

Features

- KERN PEJ: Automatic internal adjustment, guarantees high degree of accuracy and makes the balance independent of its location of use
- KERN PES: Adjusting program CAL for quick setting of the balance accuracy, external test weights at an additional price, see test weights
- Metal housing: robust and sturdy
- Weighing with tolerance range: a visual and audible signal helps with portioning, dispensing or grading
- Draught shield standard for models with weighing plate size **A**, weighing space W×D×H 170×150×100 mm
- **A**, **B** Underfloor weighing: load support with hook on the underside of the balance for models
- **A**, **B** Protective working cover included with delivery

Technical data

- Fluorescent display, bright with high contrast, digit height 14 mm
- Dimensions weighing surface, stainless steel
 - A** W×D 140×120 mm
 - B** W×D 200×200 mm, see larger picture
 - C** W×D 250×220 mm
- Overall dimensions (without draught shield) W×D×H
 - A**, **B** 220×333×93 mm
 - C** 260×330×113 mm
- Permissible ambient temperature 10 °C/30 °C

Accessories

- **A**, **B** Protective working cover, scope of delivery 5 items, KERN PES-A04S05, € 52,-
- Relay output to connect relays, signal lamps, valves etc., 5 outputs for weighing in 3 tolerance ranges, must be ordered at purchase, KERN PES-A02, € 550,-
- Minimum weight of sample, depending on the required process accuracy, only in combination with a DAkkS calibration certificate, KERN 969-103, € 10,-
- Equipment qualification: compliant qualification concept with Installation and Operating Qualification (IQ, OQ), for details see page 222
- Further details, plenty of further accessories and suitable printers see *Accessories*

STANDARD

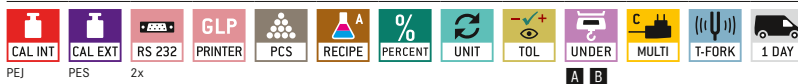

OPTION



FACTORY



| Model | Weighing capacity [Max] | Readability [d] | Verification value [e] | Minimal load [Min] | Linearity | Weighing plate | Net weight | Price excl. of VAT ex works € | Options | | | |
|---------------------|-------------------------|-----------------|------------------------|--------------------|-----------|----------------|------------|-------------------------------|---------------------|---|--------------------------------------|-------|
| | | | | | | | | | Verification M KERN | € | DAkkS Calibr. Certificate DAKKS KERN | € |
| PES 620-3M | 620 | 0,001 | - | - | ± 0,003 | A | 3,4 | 1500,- | - | - | 963-103 | 170,- |
| PES 2200-2M | 2200 | 0,01 | - | - | ± 0,02 | B | 4,4 | 1060,- | - | - | 963-127 | 103,- |
| PES 4200-2M | 4200 | 0,01 | - | - | ± 0,02 | B | 4,4 | 1250,- | - | - | 963-127 | 103,- |
| PES 6200-2M | 6200 | 0,01 | - | - | ± 0,03 | B | 4,4 | 1550,- | - | - | 963-104 | 193,- |
| PES 15000-1M | 15000 | 0,1 | - | - | ± 0,2 | B | 4,4 | 1480,- | - | - | 963-128 | 124,- |
| PES 31000-1M | 31000 | 0,1 | - | - | ± 0,4 | C | 10 | 2450,- | - | - | 963-128 | 124,- |

Note: For devices that require verification (conformity assessment according to NAWI 2014/31/EU), please include the verification when placing your order. The initial verification is not possible after delivery. Please inform the full address of the location of use for the initial verification.

| | | | | | | | | | | | | |
|--------------------|------|-------|------|-----|---------|----------|-----|---------------|---------|-------|---------|-------|
| PEJ 620-3M | 620 | 0,001 | 0,01 | 0,1 | ± 0,003 | A | 4,4 | 1800,- | 965-201 | 150,- | 963-103 | 170,- |
| PEJ 4200-2M | 4200 | 0,01 | 0,1 | 0,5 | ± 0,02 | B | 6 | 1550,- | 965-216 | 85,- | 963-127 | 103,- |
| PEJ 2200-2M | 2200 | 0,01 | 0,1 | 0,5 | ± 0,02 | B | 6 | 1350,- | 965-216 | 85,- | 963-127 | 103,- |



Multifunctional laboratory balance with single-cell weighing system, verification optional

Features

- KERN PBS: Adjusting program CAL for quick setting of the balance accuracy, external test weights at an additional price, see test weights
- KERN PBJ: Internal adjustment in the case of a change in temperature and time-controlled at defined intervals, guarantees high degree of accuracy and makes the balance independent of its location of use
- Metal housing: robust and sturdy
- Dosage aid: High stability mode and other filter settings can be selected
- Weighing with tolerance range: a visual signal helps with portioning, dispensing or grading
- Summation of weight values
- Identification number: 4 digits, printed on calibration protocol freely programmable
- Automatic data output to the PC/printer each time the balance is steady

- **A** Draught shield standard for models with weighing plate size **A**, weighing space W×D×H 180×193×87 mm, removable
- Protective working cover included with delivery

Technical data

- Large backlit LCD display, Digit height 14 mm
- Dimensions weighing surface, stainless steel
 - A** W×D 112×112 mm
 - B** W×D 180×190 mm, see larger picture
- Overall dimensions (without draught shield) W×D×H: 210×330×70 mm
- Net weight approx. 4,2 kg
- Permissible ambient temperature 10 °C/30 °C



2 Single-cell advanced technology:

- Fully automatic manufactured weighing cell from one piece of material
- Stable temperature behaviour
- Short stabilisation time: steady weight values within approx. 3 s under laboratory conditions
- Shock proof construction
- High corner load performance

Accessories

- Protective working cover, scope of delivery 5 items, for models with weighing plate size
 - A** KERN PBS-A01S05, € 52,-
 - B** KERN PBS-A02S05, € 52,-
- **1** Set for density determination of liquids and solids with density ≥ 1, for models with weighing plate size
 - A** KERN PBS-A04, € 1950,-
 - B** KERN PBS-A03, € 1950,-
- Minimum weight of sample, depending on the required process accuracy, only in combination with a DAkkS calibration certificate, KERN 969-103, € 10,-
- Equipment qualification: compliant qualification concept with Installation and Operating Qualification (IQ, OQ), for details see page 222
- Further details, plenty of further accessories and suitable printers see *Accessories*

STANDARD

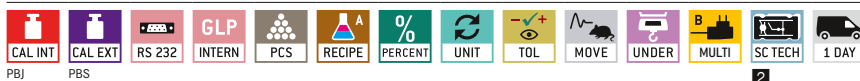

OPTION



FACTORY



| Model | Weighing capacity [Max] | Readability [d] | Verification value [e] | Minimal load [Min] | Linearity | Weighing plate | Net weight | Price excl. of VAT ex works € | Options | | | | |
|--------------------|-------------------------|-----------------|------------------------|--------------------|-----------|----------------|------------|-------------------------------|--------------|---|---------------------------|-------|--|
| | | | | | | | | | Verification | € | DAkkS Calibr. Certificate | € | |
| KERN | g | g | g | g | g | kg | kg | € | M KERN | € | DAkkS KERN | € | |
| PBS 620-3M | 620 | 0,001 | - | - | ± 0,002 | A | 3,2 | 1750,- | - | - | 963-103 | 170,- | |
| PBS 4200-2M | 4200 | 0,01 | - | - | ± 0,02 | B | 3,2 | 1540,- | - | - | 963-127 | 103,- | |
| PBS 6200-2M | 6200 | 0,01 | - | - | ± 0,02 | B | 3,4 | 1850,- | - | - | 963-104 | 193,- | |

Note: For devices that require verification (conformity assessment according to NAWI 2014/31/EU), please include the verification when placing your order.

The initial verification is not possible after delivery. Please inform the full address of the location of use for the initial verification.

| | | | | | | | | | | | | |
|--------------------|------|-------|------|-----|---------|----------|-----|---------------|---------|-------|---------|-------|
| PBJ 620-3M | 620 | 0,001 | 0,01 | 0,1 | ± 0,002 | A | 4,2 | 2050,- | 965-201 | 150,- | 963-103 | 170,- |
| PBJ 4200-2M | 4200 | 0,01 | 0,1 | 0,5 | ± 0,02 | B | 5,0 | 1900,- | 965-216 | 85,- | 963-127 | 103,- |
| PBJ 6200-2M | 6200 | 0,01 | 0,1 | 1 | ± 0,02 | B | 5,0 | 2300,- | 965-202 | 150,- | 963-104 | 193,- |
| PBJ 8200-1M | 8200 | 0,1 | 1 | 5 | ± 0,2 | B | 5,0 | 1890,- | 965-217 | 99,- | 963-128 | 124,- |

NEW



3

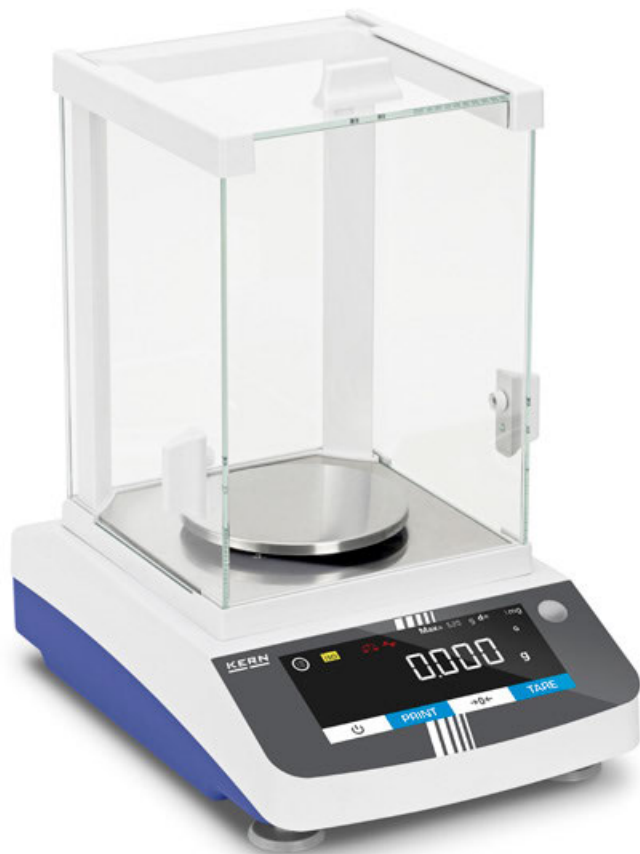

Precision balance with flexible functionality and touch display



The modern touch display enables convenient operation



Also available with a larger weighing surface



In a GLP-compliant print protocol all weights can be documented, including date, time and identification number.

Features

- The wide range of functions of this range of precision balances means that they qualify for use in the pharmaceutical industry as well as other fields. These include, for example, the statistical function, weighing with tolerance range, counting function, percentage weighing, totalizing function and many more
- Modern touch display with convenient operation enables you to, for example, switch the units or start adjustment straight from the display
- The Windows Direct function allows weights to be transferred directly from the balance to a Windows application via a USB device connection, without the need for manual entry
- Draught shield standard for models with [d] = 0,001 g, weighing space W×D×H 174×162×228 mm
- GLP/ISO record keeping with date, time and identification number of balance adjustment or weighing process
- Assists in data integrity in accordance with U.S. FDA 21 Part 11 (for example weighing result, sample ID, user name, scales ID, ...)
- KERN Communication Protocol (KCP): The KCP permits searching and remote control of the balance using external control devices or computers, see page 19
- Underfloor weighing: load support on the underside of the balance for models. Loop for underfloor weighing, standard
- RS 232 data interface and USB (Device) for the transfer of weighing data
- Menu language EN

Technical data

- Backlit LCD display, digit height 20 mm
- Dimensions weighing surface, stainless steel
 - A** ∅ 115 mm
 - B** W×D 185×185 mm
- Overall dimensions W×D×H
 - A** 207×318×360 mm
 - B** 207×318×110 mm
- Permissible ambient temperature 15 °C/25 °C

Accessories

- Protective dust cover, KERN ABS-A08, **€ 32,-**
- Weighing table to absorb vibrations and oscillations, which would otherwise distort the weighing result, KERN YPS-03, **€ 990,-**
- Antivibration plate 400×450×60 mm, KERN YPS-04, **€ 760,-**
565×450×60 mm, KERN YPS-05, **€ 980,-**
- Ioniser to neutralise electrostatic charge, KERN ABP-A01, **€ 1990,-**
- Equipment qualification: compliant qualification concept with Installation and Operating Qualification (IQ, OQ), for details see page 222
- Further details, plenty of further accessories and suitable printers see *Accessories*

3

The main scope of applications is:

- Laboratories
- Pharmaceutical industry
- Chemical industry
- Food industry
- Plastics industry
- Quality laboratories

STANDARD



OPTION



| Model | Weighing capacity [Max] | Readability [d] | Reproducibility | Linearity | Net weight | Weighing plate | Price excl. of VAT ex works € | Options | |
|---------------------------------|-------------------------|-----------------|-----------------|-----------|------------|----------------|-------------------------------|------------|-----------------------|
| | | | | | | | | DAkKS KERN | Calibr. Certificate € |
| Models with external adjustment | | | | | | | | | |
| PDS 300-3 | 320 | 0,001 | 0,003 | ± 0,003 | 6 | A | 1200,- | 963-127 | 103,- |
| PDS 600-3 | 620 | 0,001 | 0,003 | ± 0,003 | 6 | A | 1740,- | 963-103 | 170,- |
| PDS 1000-3 | 1020 | 0,001 | 0,004 | ± 0,005 | 6 | A | 2100,- | 963-103 | 170,- |
| PDS 2000-2 | 2200 | 0,01 | 0,03 | ± 0,03 | 3,6 | B | 1300,- | 963-127 | 103,- |
| PDS 4000-2 | 4200 | 0,01 | 0,03 | ± 0,03 | 3,6 | B | 1500,- | 963-127 | 103,- |
| PDS 6000-2 | 6200 | 0,01 | 0,03 | ± 0,03 | 3,6 | B | 1720,- | 963-104 | 193,- |
| Models with internal adjustment | | | | | | | | | |
| PDT 300-3 | 320 | 0,001 | 0,003 | ± 0,003 | 6 | A | 1400,- | 963-127 | 103,- |
| PDT 600-3 | 620 | 0,001 | 0,003 | ± 0,003 | 6 | A | 1940,- | 963-103 | 170,- |
| PDT 1000-3 | 1020 | 0,001 | 0,004 | ± 0,005 | 6 | A | 2300,- | 963-103 | 170,- |
| PDT 2000-2 | 2200 | 0,01 | 0,03 | ± 0,03 | 3,6 | B | 1500,- | 963-127 | 103,- |
| PDT 4000-2 | 4200 | 0,01 | 0,03 | ± 0,03 | 3,6 | B | 1700,- | 963-127 | 103,- |
| PDT 6000-2 | 6200 | 0,01 | 0,03 | ± 0,03 | 3,6 | B | 1920,- | 963-104 | 193,- |



High-capacity precision balance with password-protected user administration, with optional verification

Features

- KERN FEJ: Automatic internal adjustment, guarantees high degree of accuracy and makes the balance independent of its location of use
- KERN FES: Adjusting program CAL for quick setting of the balance accuracy, external test weights at an additional price, see *Test Weights*
- Stainless steel display device with IP65 protection, hygienic and easy to clean
- Metal housing: robust and sturdy
- User administration enables unique assignment of users and protects against unauthorised access
- Freely-assignable function keys enable individual adjustment of the balance
- IP65 dust and spray protection (in accordance with EN 60529)
- U.S. FDA 21 Part 11: assists in data integrity in accordance with U.S. FDA 21 Part 11 (for example weighing result, sample ID, user name, scales ID, ...)
- Protective working cover included with delivery

Technical data

- Large backlit LCD display, digit height 16,5 mm
- Dimensions weighing surface, stainless steel, WxD 350x400 mm
- Dimensions of display device WxDxH 290x180x80 mm
- Overall dimensions WxDxH 350x520x170 mm
- Net weight approx. 19 kg
- Permissible ambient temperature: 5 °C/35 °C

Accessories

- Protective working cover, scope of delivery 5 items, KERN FEJ-A02S05, € 52,-
- Internal rechargeable battery pack, operating time up to 10 h without backlight, charging time approx. 12 h, KERN FEJ-A01, € 760,-
- Relay output with 5 outputs for weighing in 3 tolerance ranges, KERN FEJ-A07, € 585,-
- 1 Stand to elevate display device, height of stand approx. 700 mm, KERN FEJ-A05, € 250,-
- Interface cable RS-232 to connect an external device, IP65 dust and spray protection (in accordance with EN 60529), KERN PWS-A02, € 300,-
- 2 Loop for underfloor weighing, KERN FEJ-A06, € 240,-
- Further details, plenty of further accessories and suitable printers see *Accessories*

STANDARD



OPTION



FACTORY

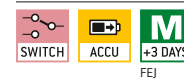

| Model | Weighing capacity [Max] g | Readability [d] g | Verification value [e] g | Minimal load [Min] g | Linearity g | Price excl. of VAT ex works € | Options | | | |
|--|---------------------------------|-------------------------|-----------------------------------|----------------------------|----------------|--|--------------|---------------|---------------------------|-------|
| | | | | | | | Verification | | DAkkS Calibr. Certificate | |
| | | | | | | € | € | DAkkS KERN | € | |
| FES 17K-4 | 17000 | 0,1 | - | - | ± 0,3 | 2850,- | - | - | 963-128 | 124,- |
| FES 33K-4 | 33000 | 0,1 | - | - | ± 0,3 | 3000,- | - | - | 963-128 | 124,- |
| FES 62K-4D | 6200 62000 | 0,1 1 | - | - | ± 0,3 3 | 3300,- | - | - | 963-129 | 153,- |
| Note: For devices that require verification (conformity assessment according to NAWI 2014/31/EU), please include the verification when placing your order. The initial verification is not possible after delivery. Please inform the full address of the location of use for the initial verification. | | | | | | | | | | |
| FEJ 17K-4M | 17000 | 0,1 | 1 | 5 | ± 0,3 | 3080,- | 965-217 | 99,- | 963-128 | 124,- |
| FEJ 33K-4M | 33000 | 0,1 | 1 | 5 | ± 0,3 | 3340,- | 965-217 | 99,- | 963-128 | 124,- |
| FEJ 62K-4DM | 6200 62000 | 0,1 1 | 1 | 5 | ± 0,3 3 | 3650,- | 965-218 | 135,- | 963-129 | 153,- |



All details on DAkkS calibration certificates for test weights, our KERN calibration service and other useful information can be found here: www.kern-lab.com

OUR KERN SERVICE FOR YOUR DAILY LABORATORY LIFE

For quality assurance and easy, compliant sequences in the laboratory, KERN offers you an extensive range of services and plenty of suitable accessories – we will be happy to advise you.

Looking for the right test equipment?

You will find that we have an enormous range of test weights and suitable calibration services – all in accordance with the current DAkkS guidelines.

For example, discover our DAkkS-calibrated KERN Safety Sets each with an appropriate test weight for correct adjusting of the balance, a small test weight for checking the minimum sample weight, plus space for another separate test weight.

Extensive details on all topics see *Test Weights*.

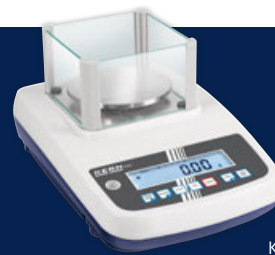

KERN Safety Sets



KERN Clean room boxes

NEW

The benefit of KERN accessories: Count on it – everything fits together!

Our product advisors can recommend the fitting accessories for your KERN devices, so that your individual weighing systems seamlessly work together in a stable and reliable way.

Our accessories tips for all KERN Laboratory balances:



Ioniser to neutralise electrostatic charge, guarantees extremely rapid ionisation. Direct installation when ordering in combination with an ABP model, KERN ABP-A01, see *Analytical Balances*



Thermal printer, KERN YKH-01 other suitable printers, see *Accessories*

Solid weighing table

Professionalism and security for a stable weighing environment. Suitable for all laboratory balances, KERN YPS-03, see *Accessories*



→ Didn't find the right product in the catalogue?

You can find the full range of accessories and available KERN test equipment on the internet under www.kern-sohn.com

4



ANALYTICAL BALANCES

Quick-Finder Analytical Balances

| Readout | Weighing range | Model | Price excl. of VAT | Page | M | CAL INT | CAL EXT | RS 232 | USB | GLP INTERN | GLP PRINTER | RECIPE |
|------------|----------------|--------------|--------------------|------|--|---------|---------|--------|-----|------------|-------------|--------|
| [d] mg | [Max] g | KERN | € | | For an explanation on the pictos, see the front flap | | | | | | | |
| 0,01 0,1 | 42 120 | ABT 120-5DNM | 2550,- | 48 | ● | ● | ● | ● | ● | ● | ● | ● |
| 0,01 0,1 | 52 120 | ABP 100-5DM | 3200,- | 50 | ● | ● | ● | ● | ● | ● | ● | ● |
| 0,01 0,1 | 52 120 | ABP 100-5DAM | 6800,- | 52 | ● | ● | ● | ● | ● | ● | ● | ● |
| 0,01 0,1 | 82 220 | ALJ 200-5DA | 2250,- | 44 | ● | ● | ● | ● | ● | ● | ● | ● |
| 0,01 0,1 | 82 220 | ABT 220-5DNM | 2650,- | 48 | ● | ● | ● | ● | ● | ● | ● | ● |
| 0,01 0,1 | 102 220 | ABP 200-5DM | 3400,- | 50 | ● | ● | ● | ● | ● | ● | ● | ● |
| 0,01 0,1 | 102 220 | ABP 200-5DAM | 9000,- | 52 | ● | ● | ● | ● | ● | ● | ● | ● |
| 0,01 | 101 | ABT 100-5NM | 2500,- | 48 | ● | ● | ● | ● | ● | ● | ● | ● |
| 0,01 | 135 | ABP 100-5M | 4200,- | 50 | ● | ● | ● | ● | ● | ● | ● | ● |
| 0,01 | 135 | ABP 100-5AM | 9200,- | 52 | ● | ● | ● | ● | ● | ● | ● | ● |
| 0,01 | 210 | ALJ 210-5A | 3250,- | 44 | ● | ● | ● | ● | ● | ● | ● | ● |
| 0,01 | 220 | ABP 200-5AM | 11200,- | 52 | ● | ● | ● | ● | ● | ● | ● | ● |
| 0,01 | 220 | ABP 200-5M | 6000,- | 50 | ● | ● | ● | ● | ● | ● | ● | ● |
| 0,1 | 82 | ACS 80-4 | 1230,- | 46 | ● | ● | ● | ● | ● | ● | ● | ● |
| 0,1 | 82 | ACJ 80-4M | 1370,- | 46 | ● | ● | ● | ● | ● | ● | ● | ● |
| 0,1 | 120 | ACS 100-4 | 1330,- | 46 | ● | ● | ● | ● | ● | ● | ● | ● |
| 0,1 | 120 | ACJ 100-4M | 1430,- | 46 | ● | ● | ● | ● | ● | ● | ● | ● |
| 0,1 | 120 | ABT 120-4NM | 1900,- | 48 | ● | ● | ● | ● | ● | ● | ● | ● |
| 0,1 | 120 | ABP 100-4M | 2200,- | 50 | ● | ● | ● | ● | ● | ● | ● | ● |
| 0,1 | 120 | ADB 600-C3 | 720,- | 43 | ● | ● | ● | ● | ● | ● | ● | ● |
| 0,1 | 120 | ADB 100-4 | 740,- | 43 | ● | ● | ● | ● | ● | ● | ● | ● |
| 0,1 | 120 | ADJ 600-C3 | 860,- | 43 | ● | ● | ● | ● | ● | ● | ● | ● |
| 0,1 | 120 | ADS 100-4 | 1550,- | 49 | ● | ● | ● | ● | ● | ● | ● | ● |
| 0,1 | 120 | ADT 100-4 | 1700,- | 49 | ● | ● | ● | ● | ● | ● | ● | ● |
| 0,1 | 120 | ADJ 100-4 | 880,- | 43 | ● | ● | ● | ● | ● | ● | ● | ● |
| 0,1 | 160 | ALS 160-4A | 1370,- | 44 | ● | ● | ● | ● | ● | ● | ● | ● |
| 0,1 | 160 | ALJ 160-4A | 1420,- | 44 | ● | ● | ● | ● | ● | ● | ● | ● |
| 0,1 | 220 | ACS 200-4 | 1430,- | 46 | ● | ● | ● | ● | ● | ● | ● | ● |
| 0,1 | 220 | ACJ 200-4M | 1530,- | 46 | ● | ● | ● | ● | ● | ● | ● | ● |
| 0,1 | 220 | ABT 220-4NM | 2300,- | 48 | ● | ● | ● | ● | ● | ● | ● | ● |
| 0,1 | 220 | ABP 200-4M | 2700,- | 50 | ● | ● | ● | ● | ● | ● | ● | ● |
| 0,1 | 220 | ABP 200-4AM | 5900,- | 52 | ● | ● | ● | ● | ● | ● | ● | ● |
| 0,1 | 220 | ADB 200-4 | 820,- | 43 | ● | ● | ● | ● | ● | ● | ● | ● |
| 0,1 | 220 | ADS 200-4 | 1750,- | 49 | ● | ● | ● | ● | ● | ● | ● | ● |
| 0,1 | 220 | ADT 200-4 | 1900,- | 49 | ● | ● | ● | ● | ● | ● | ● | ● |
| 0,1 | 220 | ADJ 200-4 | 960,- | 43 | ● | ● | ● | ● | ● | ● | ● | ● |
| 0,1 | 250 | ALS 250-4A | 1400,- | 44 | ● | ● | ● | ● | ● | ● | ● | ● |
| 0,1 | 250 | ALJ 250-4A | 1450,- | 44 | ● | ● | ● | ● | ● | ● | ● | ● |
| 0,1 | 310 | ALJ 310-4A | 1500,- | 44 | ● | ● | ● | ● | ● | ● | ● | ● |
| 0,1 | 320 | ACS 300-4 | 1630,- | 46 | ● | ● | ● | ● | ● | ● | ● | ● |
| 0,1 | 320 | ACJ 300-4M | 1730,- | 46 | ● | ● | ● | ● | ● | ● | ● | ● |
| 0,1 | 320 | ABT 320-4NM | 2600,- | 48 | ● | ● | ● | ● | ● | ● | ● | ● |
| 0,1 | 320 | ABP 300-4M | 3000,- | 50 | ● | ● | ● | ● | ● | ● | ● | ● |
| 0,1 | 320 | ABP 300-4AM | 6400,- | 52 | ● | ● | ● | ● | ● | ● | ● | ● |
| 0,1 | 320 | ADS 300-4 | 1950,- | 49 | ● | ● | ● | ● | ● | ● | ● | ● |
| 0,1 | 320 | ADT 300-4 | 2100,- | 49 | ● | ● | ● | ● | ● | ● | ● | ● |
| 0,1 | 510 | ALJ 500-4A | 2200,- | 44 | ● | ● | ● | ● | ● | ● | ● | ● |



The price leader in analytical balances, with internal or external adjustment

Features

- KERN ADJ: Automatic internal adjustment in the case of a change in temperature ≥ 2 °C or time-controlled every 3 h, guarantees high degree of accuracy and makes the balance independent of its location of use
- KERN ADB: Adjusting program CAL for quick setting of the balance accuracy, external test weights at an additional price, see *Test Weights*
- Glass draught shield with 3 sliding doors for easy access to the items being weighed standard
- **1** ADB 600-C3/ADJ 600-C3: Compact, space-saving carat balances with a readout of 0.001 ct and a weighing range of 600 ct. The high level of accuracy saves hard cash wherever you are weighing valuable precious stones
- Level indicator and levelling feet for precise levelling of the scale, fitted as standard, to give the most accurate weighing result
- Simple and convenient 6-key operation

Technical data

- Large backlit LCD display, Digit height 16 mm
- Dimensions weighing surface, stainless steel, \varnothing 90 mm
- Weighing space W×D×H
KERN ADB-C/ADJ-C: 170×160×110 mm
KERN ADB/ADJ: 170×160×205 mm
- Permissible ambient temperature 10 °C/30 °C

Accessories

- **2** Set for density determination of liquids and solids with density $\leq/\geq 1$, KERN YDB-03, **€ 380,-**
- **3** Ioniser to neutralise electrostatic charge, KERN YBI-01A, **€ 950,-**
- **4** Gemstones plate, aluminium with practical spout, W×D×H 130×80×30 mm, KERN AEJ-A05, **€ 43,-**
- **5** Weighing table to absorb vibrations and oscillations, which would otherwise distort the weighing result, KERN YPS-03, **€ 990,-**
- Minimum weight of sample, depending on the required process accuracy, only in combination with a DAkkS calibration certificate, KERN 969-103, **€ 10,-**
- Equipment qualification: compliant qualification concept with Installation and Operating Qualification (IQ, OQ), for details see page 222
- Further details, plenty of further accessories and suitable printers see *Accessories*

STANDARD

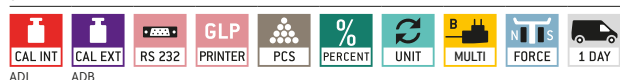

OPTION



| Model | Weighing capacity [Max] | Readability [d] | Reproducibility | Linearity | Overall dimensions W×D×H mm | Net weight kg | Price excl. of VAT ex works € | Options | |
|-----------------|-------------------------|-----------------|-----------------|------------|-----------------------------|---------------|-------------------------------|------------|-----------------------------|
| | | | | | | | | DAkkS KERN | DAkkS Calibr. Certificate € |
| KERN ADB 100-4 | 120 g | 0,1 mg | 0,2 mg | ± 0,4 mg | 230×310×330 | 4,4 | 740,- | 963-101 | 200,- |
| KERN ADB 200-4 | 220 g | 0,1 mg | 0,2 mg | ± 0,4 mg | 230×310×330 | 4,4 | 820,- | 963-101 | 200,- |
| KERN ADB 600-C3 | 600 ct | 0,001 ct | 0,002 ct | ± 0,004 ct | 230×310×210 | 3,8 | 720,- | 963-101 | 200,- |
| KERN ADJ 100-4 | 120 g | 0,1 mg | 0,2 mg | ± 0,4 mg | 230×310×330 | 5,0 | 880,- | 963-101 | 200,- |
| KERN ADJ 200-4 | 220 g | 0,1 mg | 0,2 mg | ± 0,4 mg | 230×310×330 | 5,0 | 960,- | 963-101 | 200,- |
| KERN ADJ 600-C3 | 600 ct | 0,001 ct | 0,002 ct | ± 0,004 ct | 230×310×210 | 4,6 | 860,- | 963-101 | 200,- |



KERN ALJ 200-5DA with optional ioniser **2**, see *Accessories*. High-precision semi-micro analytical balance. Thanks to its high level of precision, it is ideal for calibrating pipettes
 Note: To prevent evaporation we recommend economical capillary tubes (see standard 8655)

Analytical balances with a large weighing range, graphics display and user-friendly recipe weighing function – also as single-range semi-micro balance with unbelievably high resolution

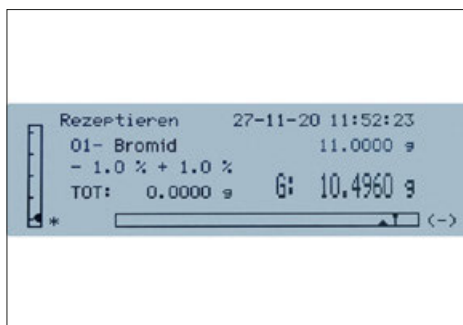

Convenient recipe-weighing with the recipe database, up to 99 recipes can be stored, each with up to 20 recipe ingredients with name and target value



Clear printout with date and time. In addition, the components of the mixture are numbered automatically and printed out with the name and weight



GLP/ISO record keeping: professional, detailed GLP Protocol, so that the balance is completely compliant with the relevant standard requirements in accordance with ISO, GLP and GMP



Features

- ALJ 210-5A: Semi-micro model with just one weighing range with unbelievably high resolution. **2** Particularly advantageous: the ioniser KERN ALJ-A03 for neutralising electrostatic charge is already fitted as standard
- Rapid working thanks to the graphics display and user-friendly, clear user guidance in German, English, French, Italian, Spanish and Portuguese
- KERN ALJ: Automatic internal adjustment, guarantees high degree of accuracy and makes the balance independent of its location of use
- KERN ALS: Adjusting program CAL for quick setting of the balance accuracy using an external test weight at an additional price, see *Test Weights*
- Short stabilisation time: steady weight values within approx. 4 s (Models with [d] = 0,1 mg) 10 s; 6 s (Models with [d] = 0,01 | 0,1 mg) under laboratory conditions
- Weighing with tolerance range: a visual and audible signal helps with portioning, dispensing or grading
- Dosage aid: High stability mode and other filter settings can be selected
- Internal memory for complete recipes with name and target value of the recipe ingredients
- Ergonomically optimised keypad for left and righthanded users
- Large glass draught shield with 3 sliding doors for easy access to the items being weighed. weighing space W×D×H 160×170×225 mm
- Compact size
- Protective working cover included with delivery

Technical data

- Backlit LCD graphic display, digit height 15 mm
- Dimensions weighing surface, stainless steel, Ø 80 mm
- Overall dimensions W×D×H 210×340×330 mm
- Permissible ambient temperature 5 °C/35 °C

Accessories

- Protective working cover, scope of delivery 5 items, KERN ALJ-A01S05, **€ 52,-**
- Protective dust cover, KERN ABS-A08, **€ 32,-**
- **1** Evaporation trap, minimises faults through evaporation when using pipettes for small volumes of 10 µl to 10 ml, KERN ALJ-A02, **€ 700,-**
- **2** Draught shield rear panel with integrated ioniser to neutralise electrostatic charge. Particularly convenient handling as you no longer need a separate device. Simply enable the ionizer fan at the push of a button. Is fitted in place of the existing glass rear panel of the draught shield. Please order at the time you order your balance, the scope of delivery is the rear panel, ionizer, Universal plug-in power supply. Factory Option, KERN ALJ-A03, **€ 600,-**
- **3** Set for density determination of liquids and solids with density ≤/≥ 1, the density is indicated directly on the display, KERN YDB-03, **€ 380,-**
- Weighing table to absorb vibrations and oscillations, which would otherwise distort the weighing result, KERN YPS-03, **€ 990,-**
- Equipment qualification: compliant qualification concept with Installation and Operating Qualification (IQ, OQ), for details see page 222
- Further details, plenty of further accessories and suitable printers see *Accessories*

STANDARD

| | | | | | | | | | | | | | |
|-----|-----|--|--|--|--|--|--|--|--|--|--|--|--|
| | | | | | | | | | | | | | |
| ALJ | ALS | | | | | | | | | | | | |

| Model | Weighing capacity [Max] g | Readability [d] mg | Reproducibility mg | Linearity mg | Net weight kg | Price excl. of VAT € | Options | |
|---|---------------------------------|--------------------------|-----------------------|-----------------|------------------|----------------------------|---------------|--------------------------|
| | | | | | | | DAkKS KERN | Calibr. Certificate € |
| KERN | | | | | | | | |
| ALS 160-4A | 160 | 0,1 | 0,1 | ± 0,3 | 7 | 1370,- | 963-101 | 200,- |
| ALS 250-4A | 250 | 0,1 | 0,1 | ± 0,3 | 7 | 1400,- | 963-101 | 200,- |
| ALJ 210-5A | 210 | 0,01 | 0,05 | ± 0,1 | 6 | 3250,- | 963-101 | 200,- |
| ALJ 160-4A | 160 | 0,1 | 0,1 | ± 0,3 | 7 | 1420,- | 963-101 | 200,- |
| ALJ 250-4A | 250 | 0,1 | 0,1 | ± 0,3 | 7 | 1450,- | 963-101 | 200,- |
| ALJ 310-4A | 310 | 0,1 | 0,1 | ± 0,3 | 7 | 1500,- | 963-101 | 200,- |
| ALJ 500-4A | 510 | 0,1 | 0,2 | ± 0,4 | 7 | 2200,- | 963-101 | 200,- |
| Multi-range balance, with increasing load it switches automatically to the next largest weighing range [Max] and readout [d] and when the load is fully removed, the balance switches back to the lower range | | | | | | | | |
| ALJ 200-5DA | 82 220 | 0,01 0,1 | 0,04 0,1 | ± 0,1 0,2 | 7 | 2250,- | 963-101 | 200,- |



The bestseller in analytical balances, with high-quality single-cell weighing system, verification optional



Single-cell advanced technology:

- Fully automatic manufactured weighing cell from one piece of material
- Stable temperature behaviour
- Short stabilisation time: steady weight values within approx. 3 s under laboratory conditions
- Shock proof construction
- High corner load performance



USB data interfaces and RS-232 for transferring weighing data to the PC, tablet, printer or USB



Features

- KERN ACJ: Automatic internal adjustment in the case of a change in temperature $\geq 2\text{ }^{\circ}\text{C}$ or time-controlled every 4 h, guarantees high degree of accuracy and makes the balance independent of its location of use
- KERN ACS: Adjusting program CAL for quick setting of the balance accuracy, external test weights at an additional price, see *Test Weights*
- Dosage aid: High stability mode and other filter settings can be selected
- Simple recipe weighing and documenting with a combined tare/print function. In addition, the ingredients for the recipe are numbered automatically and printed out with their corresponding number and nominal weight
- Automatic data output to the PC/printer each time the balance is steady
- Identification number: 4 digits, printed on calibration protocol freely programmable
- Protective working cover included with delivery

Technical data

- Large LCD display, digit height 14 mm
- Dimensions weighing surface, stainless steel, $\varnothing 91\text{ mm}$
- weighing space W×D×H 174×162×227 mm
- Overall dimensions W×D×H 213×333×338 mm
- Net weight approx. 7 kg
- Permissible ambient temperature $10\text{ }^{\circ}\text{C}/30\text{ }^{\circ}\text{C}$

Accessories

- Protective working cover, scope of delivery 5 items, KERN ACS-A02S05, **€ 52,-**
- **1** Set for density determination of liquids and solids with density $\leq/\geq 1$, the density is indicated directly on the display, KERN YDB-03, **€ 380,-**
- **2** Ioniser to neutralise electrostatic charge, KERN YBI-01A, **€ 950,-**
- **3** Weighing table to absorb vibrations and oscillations, which would otherwise distort the weighing result, KERN YPS-03, **€ 990,-**
- Minimum weight of sample, depending on the required process accuracy, only in combination with a DAkkS calibration certificate, KERN 969-103, **€ 10,-**
- Equipment qualification: compliant qualification concept with Installation and Operating Qualification (IQ, OQ), for details see page 222
- Further details, plenty of further accessories and suitable printers see *Accessories*

STANDARD



OPTION



FACTORY



| Model | Weighing capacity [Max] | Readability | Verification value | Minimal load | Reproducibility | Linearity | Price excl. of VAT ex works € | Options | | | | |
|-----------|-------------------------|-------------|--------------------|--------------|-----------------|-----------|-------------------------------|--------------|---------------|---------------|-------|--|
| | | | | | | | | Verification | DAkkS Calibr. | Certificate | | |
| KERN | g | [d] mg | [e] mg | [Min] mg | mg | mg | € | MT KERN | € | DAkkS KERN | € | |
| ACS 80-4 | 82 | 0,1 | - | - | 0,2 | $\pm 0,3$ | 1230,- | - | - | 963-101 | 200,- | |
| ACS 100-4 | 120 | 0,1 | - | - | 0,2 | $\pm 0,3$ | 1330,- | - | - | 963-101 | 200,- | |
| ACS 200-4 | 220 | 0,1 | - | - | 0,2 | $\pm 0,3$ | 1430,- | - | - | 963-101 | 200,- | |
| ACS 300-4 | 320 | 0,1 | - | - | 0,2 | $\pm 0,3$ | 1630,- | - | - | 963-101 | 200,- | |

Note: For devices that require verification (conformity assessment according to NAWI 2014/31/EU), please include the verification when placing your order.

The initial verification is not possible after delivery. Please inform the full address of the location of use for the initial verification.

| | | | | | | | | | | | |
|------------|-----|-----|---|----|-----|-----------|--------|---------|-------|---------|-------|
| ACJ 80-4M | 82 | 0,1 | 1 | 10 | 0,2 | $\pm 0,3$ | 1370,- | 965-201 | 150,- | 963-101 | 200,- |
| ACJ 100-4M | 120 | 0,1 | 1 | 10 | 0,2 | $\pm 0,3$ | 1430,- | 965-201 | 150,- | 963-101 | 200,- |
| ACJ 200-4M | 220 | 0,1 | 1 | 10 | 0,2 | $\pm 0,3$ | 1530,- | 965-201 | 150,- | 963-101 | 200,- |
| ACJ 300-4M | 320 | 0,1 | 1 | 10 | 0,2 | $\pm 0,3$ | 1730,- | 965-201 | 150,- | 963-101 | 200,- |



4



The premium model with single-cell weighing system



- 4** Single-cell advanced technology:
- Fully automatic manufactured weighing cell from one piece of material
 - Stable temperature behaviour
 - Short stabilisation time: steady weight values within approx. 4 s (models with [d] = 0,1 mg), approx. 10 s (models with [d] = 0,01 mg) under laboratory conditions
 - Shock proof construction
 - High corner load performance

Features

- Automatic internal adjustment in the case of a change in temperature $\geq 0,5\text{ }^{\circ}\text{C}$ or timecontrolled every 4 h, guarantees high degree of accuracy and makes the balance independent of its location of use
- Dosage aid: High stability mode and other filter settings can be selected
- Simple recipe weighing and documenting with a combined tare/print function. The ingredients for the recipe are automatically numbered and printed with weight value
- Identification number: 4 digits, printed on calibration protocol freely programmable
- Printout of a GLP-compliant calibration report conveniently at the touch of a button
- Automatic data output to the PC/printer each time the balance is steady
- Large glass draught shield with 3 sliding doors for easy access to the items being weighed.
- Protective working cover included with delivery

Technical data

- Large LCD display, digit height 14 mm
- Dimensions weighing surface, stainless steel, $\varnothing 80\text{ mm}$
- weighing space WxDxH 168x172x223 mm
- Overall dimensions WxDxH 217x356x338 mm
- Net weight approx. 8 kg
- Permissible ambient temperature $10\text{ }^{\circ}\text{C}/30\text{ }^{\circ}\text{C}$

Accessories

- Protective working cover, scope of delivery 5 items, KERN ABT-A02S05, **€ 52,-**
- **1** Set for density determination of liquids and solids with density $\leq/\geq 1$, the density is indicated directly on the display, KERN YDB-03, **€ 380,-**
- **2** Ioniser to neutralise electrostatic charge, KERN YBI-01A, **€ 950,-**
- **3** Weighing table to absorb vibrations and oscillations, which would otherwise distort the weighing result, KERN YPS-03, **€ 990,-**
- Minimum weight of sample, depending on the required process accuracy, only in combination with a DAkkS calibration certificate, KERN 969-103, **€ 10,-**
- Equipment qualification: compliant qualification concept with Installation and Operating Qualification (IQ, OQ), for details see page 222
- Further details, plenty of further accessories and suitable printers see *Accessories*

STANDARD

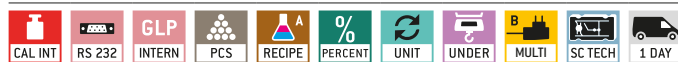

OPTION



FACTORY



| Model | Weighing capacity [Max] | Readability [d] | Verification value [e] | Minimal load [Min] | Reproducibility | Linearity | Price excl. of VAT ex works € | Options | | | |
|---------------------|-------------------------|-----------------|------------------------|--------------------|-----------------|------------|-------------------------------|----------------------|-------|---------------------------|-------|
| | | | | | | | | Verification MT KERN | € | DAkkS Calibr. Certificate | € |
| ABT 100-5NM | 101 | 0,01 | 1 | 1 | 0,05 | $\pm 0,15$ | 2500,- | 965-201** | 150,- | 963-101 | 200,- |
| ABT 120-4NM* | 120 | 0,1 | 1 | 10 | 0,1 | $\pm 0,2$ | 1900,- | 965-201** | 150,- | 963-101 | 200,- |
| ABT 220-4NM* | 220 | 0,1 | 1 | 10 | 0,1 | $\pm 0,2$ | 2300,- | 965-201** | 150,- | 963-101 | 200,- |
| ABT 320-4NM* | 320 | 0,1 | 1 | 10 | 0,15 | $\pm 0,3$ | 2600,- | 965-201** | 150,- | 963-101 | 200,- |

Multi-range balance, with increasing load it switches automatically to the next largest weighing range [Max] and readout [d] and when the load is fully removed, the balance switches back to the lower range

| | | | | | | | | | | | |
|---------------------|----------|------------|-------|---|------------|------------------|---------------|-----------|-------|---------|-------|
| ABT 120-5DNM | 42 120 | 0,01 0,1 | 1 1 | 1 | 0,02 0,1 | $\pm 0,03 0,2$ | 2550,- | 965-201** | 150,- | 963-101 | 200,- |
| ABT 220-5DNM | 82 220 | 0,01 0,1 | 1 1 | 1 | 0,05 0,1 | $\pm 0,1 0,2$ | 2650,- | 965-201** | 150,- | 963-101 | 200,- |

Note: For devices that require verification (conformity assessment according to NAWI 2014/31/EU), please include the verification when placing your order.

The initial verification is not possible after delivery. Please inform the full address of the location of use for the initial verification.

1 *ONLY WHILE STOCKS LAST **Conformity assessment only possible until 18/06/2025

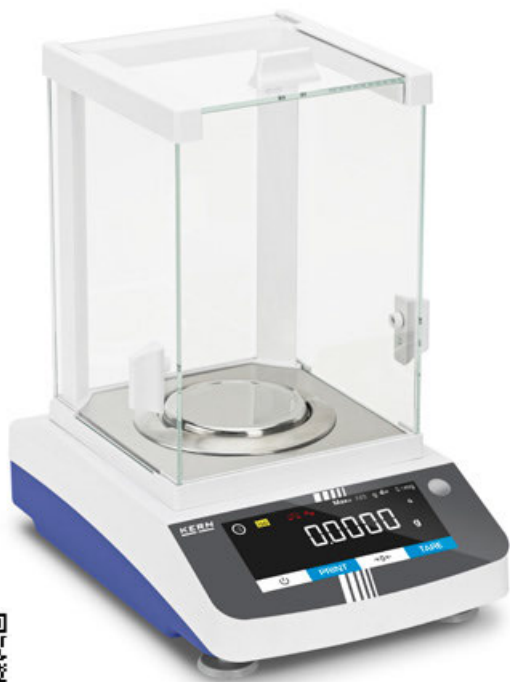

NEW



Analytical balance with flexible functionality and touch display

Features

- The wide range of functions of this range of analytical balances means that they qualify for use in the pharmaceutical industry as well as other fields. These include, for example, the statistical function, weighing with tolerance range, counting function, percentage weighing, totalizing function and many more
- 1** Modern touch display with convenient operation enables you to, for example, switch the units or start adjustment straight from the display
- Draught shield standard
- Specialised functions, such as the statistical function make it easier to use efficiently in industry and the laboratory
- GLP/ISO record keeping with date, time and identification number of balance adjustment or weighing process

- Assists in data integrity in accordance with U.S. FDA 21 Part 11 (for example weighing result, sample ID, user name, scales ID, ...)
- Data query and remote control of the balance using a computer or CRM/ERP systems using the KERN Communication Protocol
- RS 232 data interface and USB (Device) for the transfer of weighing data
- Menu language EN

Technical data

- Backlit LCD display, digit height 20 mm
- Dimensions weighing surface, stainless steel, \varnothing 90 mm
- Overall dimensions W×D×H 207×318×360 mm
- Net weight approx. 6 kg
- Permissible ambient temperature 15 °C/25 °C

Accessories

- Protective dust cover, KERN ABS-A08, **€ 32,-**
- Weighing table to absorb vibrations and oscillations, which would otherwise distort the weighing result, KERN YPS-03, **€ 990,-**
- Antivibration plate
400×450×60 mm, KERN YPS-04, **€ 760,-**
565×450×60 mm, KERN YPS-05, **€ 980,-**
- Ioniser to neutralise electrostatic charge, KERN ABP-A01, **€ 1990,-**
- Equipment qualification: compliant qualification concept with Installation and Operating Qualification (IQ, OQ), for details see page 222
- Further details, plenty of further accessories and suitable printers see *Accessories*

The main scope of applications is:

- Laboratories
- Pharmaceutical industry
- Chemical industry
- Food industry
- Plastics industry
- Quality laboratories

STANDARD



OPTION



| Model | Weighing capacity [Max] g | Readability [d] mg | Reproducibility mg | Linearity mg | Price excl. of VAT ex works € | Options | |
|---------------------------------|---------------------------------|--------------------------|-----------------------|-----------------|--|---------------|--------------------------|
| | | | | | | DAKKS KERN | Calibr. Certificate € |
| Models with external adjustment | | | | | | | |
| ADS 100-4 | 120 | 0,1 | 0,3 | ± 0,3 | 1550,- | 963-101 | 200,- |
| ADS 200-4 | 220 | 0,1 | 0,3 | ± 0,3 | 1750,- | 963-101 | 200,- |
| ADS 300-4 | 320 | 0,1 | 0,4 | ± 0,4 | 1950,- | 963-101 | 200,- |
| Models with internal adjustment | | | | | | | |
| ADT 100-4 | 120 | 0,1 | 0,3 | ± 0,3 | 1700,- | 963-101 | 200,- |
| ADT 200-4 | 220 | 0,1 | 0,3 | ± 0,3 | 1900,- | 963-101 | 200,- |
| ADT 300-4 | 320 | 0,1 | 0,4 | ± 0,4 | 2100,- | 963-101 | 200,- |



Premium analytical balance with the latest Single-Cell Generation for extremely rapid, stable weighing results



1 The internal draught shield minimises the effect of currents of air in the weighing chamber and therefore significantly improves the stabilisation time and repeatability, see *Accessories*

2 Extremely fast ionization process, thanks to the latest generation of KERN ionization technology to neutralise electrostatic charge, see *Accessories*

GLP/ISO record keeping: professional, detailed GLP Protocol, so that the balance is completely compliant with the relevant standard requirements in accordance with ISO, GLP and GMP

Features

- Large glass draught shield with 3 sliding doors for easy access to the items being weighed
- Navigation pad for quick navigating through the menus
- Automatic internal adjustment in the case of a change in temperature ≥ 1 °C or timecontrolled every 4 h, guarantees high degree of accuracy and makes the balance independent of its location of use
- The minimum weight of sample can be manually stored in the device or automatically calculated. For weighings below this value, the balance issues a warning message
- Dosage aid: High stability mode and other filter settings can be selected
- Simple recipe weighing and documenting with a combined tare/print function. In addition, the ingredients for the recipe are numbered automatically and printed out with their corresponding number and nominal weight
- Individual settings can be stored for up to 10 users: User name/number, password, menu language, user profile. Settings can be recalled using the barcode. Guest mode for users who are not logged in, specific permissions (e.g. for adjustment, recipe changes) only for authorised users
- RS-232 data interfaces and USB (device) for transferring weighing data and USB (host) to connect a USB keyboard
- U.S. FDA 21 Part 11: assists in data integrity in accordance with U.S. FDA 21 Part 11 (for example weighing result, sample ID, user name, scales ID, ...)
- Menu languages DE, EN
- Automatic data output to the PC/printer each time the balance is steady

- Standard for models with [d] 0,01 mg: Multi-function weighing plate included with delivery, minimises the effect of currents of air in the weighing chamber and therefore significantly improves the stabilisation time and repeatability. In addition samples, sample paper, PCR containers, micro centrifuge tubes and many other items which protrude can be easily fixed in place and weighed easily
- ABP 200-5M: Erlenmeyer flask holder included with delivery
- Protective working cover included with delivery

Technical data

- Luminescent OLED display, digit height 12 mm bright with high contrast, for easy reading of the weight, even in poor lighting conditions
- Dimensions weighing surface, stainless steel, \varnothing 91 mm
- Overall dimensions WxDxH 220x370x350 mm
- Net weight approx. 8 kg
- Permissible ambient temperature 10 °C/30 °C

Accessories

- Protective working cover, scope of delivery 5 items, KERN YBA-A06S05, **€ 52,-**
- Set for density determination of liquids and solids with density $\leq/\geq 1$, the density is indicated directly on the display, KERN YDB-03, **€ 380,-**
- **1** Internal draught shield made of glass, KERN ABP-A02, **€ 165,-**
- **2** Ioniser to neutralise electrostatic charge. Suitable for all models in the ABP range. Please order together with the balance you want so that it can be fitted into the rear panel of the balance, KERN ABP-A01, **€ 1990,-**
- USB barcode scanner, hand-held version, dimensions WxDxH 152x84x63 mm, KERN PET-A09, **€ 300,-**
- Minimum weight of sample, depending on the required process accuracy, only in combination with a DAkkS calibration certificate, KERN 969-103, **€ 10,-**
- Equipment qualification: compliant qualification concept with Installation and Operating Qualification (IQ, OQ), for details see page 222
- Further details, plenty of further accessories and suitable printers see *Accessories*

4

Single-cell advanced technology:

- Fully automatic manufactured weighing cell from one piece of material
- Stable temperature behaviour
- Short stabilisation time: steady weight values within approx. 2 s (models with [d] = 0,1 mg), approx. 8 s (models with [d] = 0,01 mg) under laboratory conditions
- Shock proof construction
- High corner load performance

STANDARD

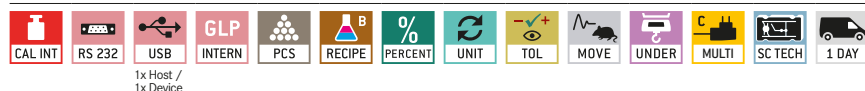

OPTION

FACTORY



| Model | Weighing capacity [Max] | Readability [d] | Verification value | Minimal load | Reproducibility | Linearity | Price excl. of VAT ex works € | Options | | | |
|---|-------------------------|-----------------|--------------------|--------------|-----------------|------------------|-------------------------------|--------------|-------|------------|---------------------|
| | | | | | | | | Verification | € | DAkkS | Calibr. Certificate |
| KERN | g | mg | mg | mg | mg | mg | | MT KERN | € | DAkkS KERN | € |
| ABP 100-5M | 135 | 0,01 | 1 | 1 | 0,05 | $\pm 0,1$ | 4200,- | 965-201 | 150,- | 963-101 | 200,- |
| ABP 200-5M | 220 | 0,01 | 1 | 1 | 0,015 | $\pm 0,1$ | 6000,- | 965-201 | 150,- | 963-101 | 200,- |
| ABP 100-4M | 120 | 0,1 | 1 | 10 | 0,1 | $\pm 0,2$ | 2200,- | 965-201 | 150,- | 963-101 | 200,- |
| ABP 200-4M | 220 | 0,1 | 1 | 10 | 0,1 | $\pm 0,2$ | 2700,- | 965-201 | 150,- | 963-101 | 200,- |
| ABP 300-4M | 320 | 0,1 | 1 | 10 | 0,15 | $\pm 0,3$ | 3000,- | 965-201 | 150,- | 963-101 | 200,- |
| Multi-division balance, with increasing or decreasing load, it switches automatically to the next largest or smallest weighing range [Max] and readout [d]. | | | | | | | | | | | |
| ABP 100-5DM | 52 120 | 0,01 0,1 | 1 1 | 1 | 0,02 0,1 | $\pm 0,05 0,2$ | 3200,- | 965-201 | 150,- | 963-101 | 200,- |
| ABP 200-5DM | 102 220 | 0,01 0,1 | 1 1 | 1 | 0,05 0,1 | $\pm 0,1 0,2$ | 3400,- | 965-201 | 150,- | 963-101 | 200,- |

Note: For devices that require verification (conformity assessment according to NAWI 2014/31/EU), please include the verification when placing your order. The initial verification is not possible after delivery. Please inform the full address of the location of use for the initial verification.

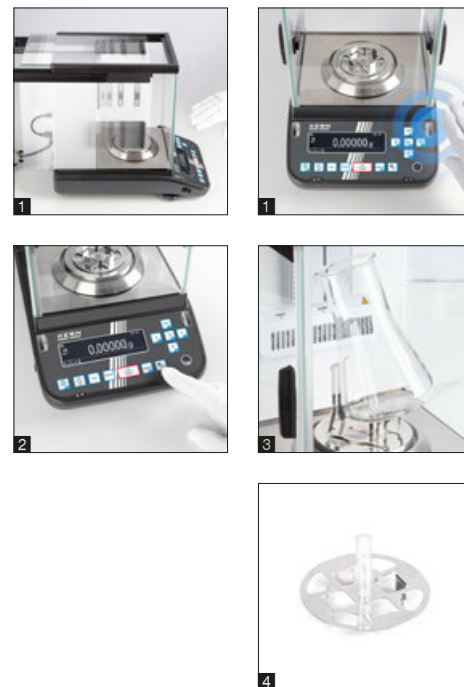

4

Version with automatic sliding doors and other innovative features

Features

- **1** Large glass draught shield: with 3 automatic sliding doors, which can be opened and closed using sensors, and integrated ioniser as standard. Thanks to the Memory Function, the balance stores how far the sliding doors have been opened. This prevents contamination and accelerates processes. Touching the sliding doors “gently” activates the push function and the doors open and shut automatically. Opening possible alternatively via button
- **2** Ioniser (included) can be activated at the touch of a button
- The adjustable internal draft shield minimises the effect of currents of air in the weighing space and guarantees maximum stability of the weight readings, only for 0.01 mg models of the series ABP-A

- **3** Erlenmeyer piston holder, included as standard with ABP 200-5M and ABP 200-5AM
- **4** Standard for models with [d] 0,01 mg: Multi-function weighing plate

Technical data

- Luminescent OLED display, digit height 12 mm bright with high contrast, for easy reading of the weight, even in poor lighting conditions
- Dimensions weighing surface \varnothing 91 mm, stainless steel
- weighing space WxDxH 166x156x220 mm
- Overall dimensions WxDxH 220x370x350 mm
- Net weight approx. 8 kg
- Permissible ambient temperature 10 °C/30 °C

Accessories

- Protective working cover, scope of delivery 5 items, KERN YBA-A06S05, **€ 52,-**
- Set for density determination of liquids and solids with density \leq/\geq 1, the density is indicated directly on the display, KERN YDB-03, **€ 380,-**
- USB barcode scanner, hand-held version, dimensions WxDxH 152x84x63 mm, KERN PET-A09, **€ 300,-**
- Minimum weight of sample, depending on the required process accuracy, only in combination with a DAkkS calibration certificate, KERN 969-103, **€ 10,-**
- Equipment qualification: compliant qualification concept with Installation and Operating Qualification (IQ, OQ), for details see page 222

STANDARD

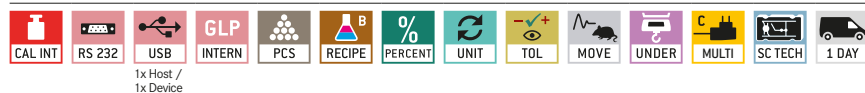

OPTION

FACTORY



| Model | Weighing capacity [Max] | Readability [d] | Verification value [e] | Minimal load [Min] | Reproducibility | Linearity | Price excl. of VAT ex works € | Options | | | |
|-------------|-------------------------|-----------------|------------------------|--------------------|-----------------|-----------|-------------------------------|--------------|-------|---------------------------|-------|
| | | | | | | | | Verification | € | DAkkS Calibr. Certificate | € |
| KERN | g | mg | mg | mg | mg | mg | | MT KERN | € | DAkkS KERN | € |
| ABP 100-5AM | 135 | 0,01 | 1 | 1 | 0,05 | $\pm 0,1$ | 9200,- | 965-201 | 150,- | 963-101 | 200,- |
| ABP 200-5AM | 220 | 0,01 | 1 | 1 | 0,015 | $\pm 0,1$ | 11200,- | 965-201 | 150,- | 963-101 | 200,- |
| ABP 200-4AM | 220 | 0,1 | 1 | 10 | 0,1 | $\pm 0,2$ | 5900,- | 965-201 | 150,- | 963-101 | 200,- |
| ABP 300-4AM | 320 | 0,1 | 1 | 10 | 0,15 | $\pm 0,3$ | 6400,- | 965-201 | 150,- | 963-101 | 200,- |

Multi-division balance, with increasing or decreasing load, it switches automatically to the next largest or smallest weighing range [Max] and readout [d].

| | | | | | | | | | | | |
|--------------|-----------|------------|-------|---|------------|------------------|---------------|---------|-------|---------|-------|
| ABP 100-5DAM | 52 120 | 0,01 0,1 | 1 1 | 1 | 0,02 0,1 | $\pm 0,05 0,2$ | 6800,- | 965-201 | 150,- | 963-101 | 200,- |
| ABP 200-5DAM | 102 220 | 0,01 0,1 | 1 1 | 1 | 0,05 0,1 | $\pm 0,1 0,2$ | 9000,- | 965-201 | 150,- | 963-101 | 200,- |

Note: For devices that require verification (conformity assessment according to NAWI 2014/31/EU), please include the verification when placing your order.

The initial verification is not possible after delivery. Please inform the full address of the location of use for the initial verification.

5



MOISTURE ANALYSERS

They have a number of memories, network connectivity, different heating modes and are easy to use due to the intuitive operation and easy-to-read displays. Our high-quality moisture analysers are ideal for use in the food processing industry, water resource management, plastics industry, the energy industry or agriculture.

Halogen moisture analysers for rapid, reliable measuring results

Our models work on the thermogravimetric principle which means the sample is weighed and warmed with a halogen lamp. During this procedure, the weight loss is recorded continuously while it is drying until it reaches the defined value. The current moisture content for the sample can then be automatically calculated from the measured weight difference. All benefits of our moisture analysers with halogen drying:

- Even heating of the sample without risk of burning
- Rapid amortisation through low purchase costs
- Temperature ranges from 35 to 200 degrees
- High level of measurement accuracy to 0.01 %
- Spare capacity, weighing range up to 200 g
- You can select between different heating profiles
- You can select between different switch-off criteria, automatic or time-controlled

The drying programs

Depending on the model, our moisture analysers have different heating profiles, so the procedure can be adapted to best suit the sample in question.

- The standard drying setting is suitable for most types of sample. As an option you can choose between these two types of switch-off criteria: Automatic drying (AUTO) or time-controlled (TIME)
- Rapid drying is suitable for samples with a high moisture content
- Smooth heating through gentle drying prevents disintegration and formation of a skin
- As an alternative to rapid drying, you can also use stage drying as well. The temperature and the time period for the increase in temperature can be freely selected. Equally, the moisture can be determined selectively for different temperatures

Our recommendation: The high-performance DBS moisture analyser with excellent stability, reliability and reaction speed, 10 drying programs can be stored and memory for 100 drying processes carried out as well as a USB and RS 232 data interface.

Simple data transfer

For easy, convenient communication between the moisture analyser and printer, or PC there are interfaces available, for example to connect a USB or Ethernet. The devices themselves have several internal memories, where you can store drying programs with drying parameters, such as, for example, drying period, drying temperature, display settings, switch-off criteria etc. This saves time and guarantees repeatable results. Compatible printers to print out weights, calibration and interface kits are available in our extensive range of accessories, suitable for each moisture analyser.

For communication between the balance and the printer, the moisture analyser must be disconnected from the power supply and connected to the printer. We guarantee fault-free operation with the KERN interface cable. To transfer the values to the PC we recommend our "Balance Connection KERN SCD 4.0" transfer software. Programs such as Excel or other spreadsheet applications are ideal for displaying graphics.

Our recommendation: DLB moisture analyser with intuitive graphics display, multi-lingual user guidance, convenient Auto-Tare when closing the lid and RS 232 data interface.





Our service options

In order for the comparability of the results of moisture analyses to be guaranteed, the correct temperatures must be maintained in the heating chamber or sample. We offer our customers regular calibration of the temperature for genuine and reliable measuring results KERN 964-305, € 174,-

If requested, we can carry out sample analysis for you and support you in adjusting the parameters of your moisture analyser KERN 965-243, € 95,-/hour.

Please contact your personal customer advisor if you would like us to help!

Quick-Finder Moisture Analysers

| Readout | Weighing range | Model | Price excl. of VAT ex works | Page |  |  |  |  |  |
|---------|----------------|------------|-----------------------------|------|---|---|---|---|---|
| [d] | [Max] | KERN | € | | For an explanation on the pictos, see the front flap | | | | |
| g | g | | | | | | | | |
| 0,001 | 60 | DBS 60-3 | 1650,- | 55 | ● | ● | ● | ● | ● |
| 0,001 | 110 | DAB 100-3 | 1250,- | 54 | ● | ● | ● | ● | ● |
| 0,001 | 160 | DLB 160-3A | 1450,- | 56 | ● | ● | ● | ● | ● |
| 0,01 | 200 | DAB 200-2 | 1200,- | 54 | ● | ● | ● | ● | ● |

● Standard ○ Option



5

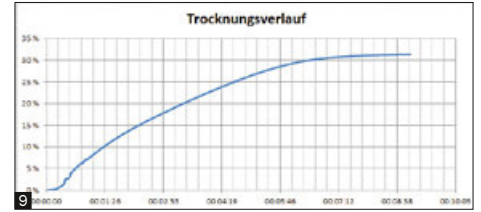
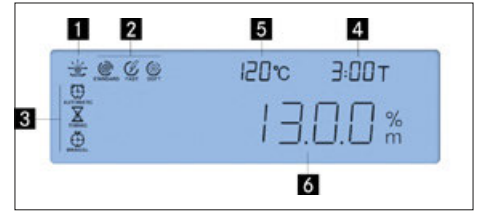

Particularly user-friendly moisture analyser with high-quality halogen quartz glass heater – also available as version with [d] = 10 mg, ideal for recurring rapid tests

Features

- KERN DAB 200-2: Version with lower resolution, whereby the switch-off criterion is reached faster, which saves time. Ideal for quick tests and spot checks
- Backlit graphic display, digit height 14 mm
- 1 Active drying process
- 2 Active heating profile
- 3 Active switch-off criteria
- 4 Previous drying time

- 5 Current temperature
- 6 Current moisture content in %
- 400 W halogen-quartz glass heater
- Suitable for temperature-insensitive samples
- Helpful observation window above the sample
- Internal memory for automatic sequence of 15 complete drying processes and 5 drying processes carried out
- The last value measured remains on the display until it is replaced by a new measurement

- 50 sample plates included
- On the internet, you will find a practical application handbook containing many examples, field reports, settings and tips for each KERN moisture analyser
- Note: both models are also available in infrared version, see *accessories*

STANDARD



OPTION



| KERN | DAB 100-3 | DAB 200-2 |
|--|---|-----------------|
| Readability [d] Weight/Moisture (%) | 0,001 g / 0,01 % | 0,01 g / 0,05 % |
| Weighing capacity [Max] | 110 g | 200 g |
| Reproducibility weight of sample 2 g* | 0,15 % | 1,5 % |
| Reproducibility weight of sample 10 g* | 0,03 % | 0,3 % |
| Display after drying (Display can be switched over at any time) | | |
| Moisture [%] = Moisture content (M) from wet weight (W) | 20 - 100 % | |
| Dry content [%] = Dry weight (D) from [W] | 100 - 20 % | |
| Moisture content (M) | Absolute value in [g] | |
| Temperature range (in steps up to) | 40 °C - 199 °C (1 °C) | |
| Drying modes | Standard drying Gentle drying Rapid drying | |
| Switch-off criteria | <ul style="list-style-type: none"> • Automatic switch-off (2 mg loss in weight in 45 s) • Time controlled switch-off (3 min - 99 min 59 s, 10 s increments) • Manual switch-off at the press of a button | |
| Recall of measurement/ Log output | Interval can be set from 1 s - 10 min (Only when used with printer or PC) | |
| Overall dimensions WxDxH | 240x365x180 mm | |
| Net weight | 4,82 kg | |
| Price excl. of VAT ex works € | 1250,- | 1200,- |
| Option DAKKS Calibr. Certificate Mass | 963-127, € 103,- | |
| Option Factory Calibr. Certificate Temperature | 964-305, € 174,- | |

* application-dependent

Accessories

- Sample plates aluminium, ø 90 mm, unit of 80 pieces, KERN MLB-A01A, € 45,-
- Round fiberglass filter, medium mechanical stability, without organic binder, box of 100 pieces, KERN RH-A02, € 79,-
- 7 Temperature calibration set consists of measuring sensor and display device, KERN DAB-A01., € 200,-
- 8 Infrared quartz glass heater, temperature range 40 °C-160 °C, Factory Option, KERN DAB-A02, € 198,-
- 9 BalanceConnection software for flexible measured value recording or transmission, compatible with Microsoft® Excel, Access and other applications, Scope of supplies: Download link for 1 license, KERN SCD-4.0-DL, € 210,-
- Thermal printer, KERN YKH-01, € 420,-
- Matrix needle printer, to print the weights on normal paper, ideal for long-term archiving, KERN 911-013, € 480,-



Moisture analyser with high-quality single-cell weighing system for outstanding stability, reliability and response speed

Features

- Tip: Suitable for samples with low moisture content, e.g. plastics
- Backlit graphic display, digit height 15 mm
- 1 Active drying process
- 2 Previous drying time

- 3 Current temperature
- 4 Unit for displaying the results
- 5 Current moisture content in %
- 6 Active heating profile
- 400 W halogen-quartz glass heater
- Excellent temperature control thanks to halogen technology, suitable for temperature-sensitive samples

STANDARD



OPTION



| KERN | DBS 60-3 |
|---|---|
| Readability [d] Weight/Moisture (%) | 0,001 g / 0,01 % |
| Weighing capacity [Max] | 60 g |
| Reproducibility weight of sample 2 g* | 0,15 % |
| Reproducibility weight of sample 10 g* | 0,02 % |
| Display after drying | |
| Moisture [%] = Moisture content (M) from wet weight (W) | 0 - 100 % |
| Dry content [%] = Dry weight (D) from [W] | 100 - 0 % |
| ATRO [%] [(W-D) : D] · 100 % | 0 - 999 % |
| Moisture content (M) | Absolute value in [g] |
| Temperature range (in steps up to) | 50 °C - 200 °C (1 °C) |
| Drying modes | Standard drying Drying in levels Gentle drying Rapid drying |
| Switch-off criteria | • Automatic unrestricted switch-off (Selectable loss in weight 0,01% - 0,1% in 30 s) • Time controlled switch-off (1 min - 12 h) • Manual switch-off at the press of a button |
| Recall of measurement/ Log output | Interval can be set from 1 s - 10 min (Only when used with printer or PC) |
| Overall dimensions W×D×H | 204×336×167 mm |
| Net weight | 4,6 kg |
| Price excl. of VAT ex works € | 1650,- |
| Option DAKKS Calibr. Certificate Mass | 963-127, € 103,- |
| Option Factory Calibr. Certificate Temperature | 964-305, € 174,- |

* application-dependent

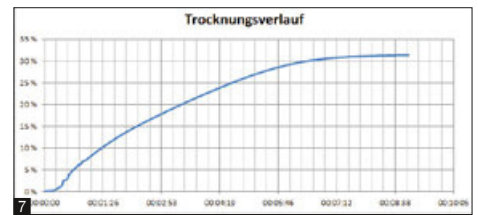
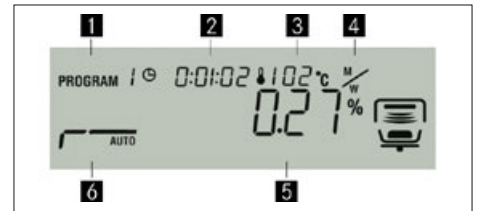

5

- Internal memory for automatic sequence of 10 complete drying processes and 100 drying processes carried out
- The last measured value remains visible in the display until the next measurement
- Password protection to prevent manipulation of stored settings, data, etc.
- Sample description for up to 99 samples, freely programmable, and is printed in the measuring protocol
- Date and time display as standard
- USB data interface for transferring weighing data to the PC, printer etc.
- 50 sample plates included
- Protective working cover included with delivery
- On the internet, you will find a practical application handbook containing many examples, field reports, settings and tips for each KERN moisture analyser

Accessories

- Protective working cover, scope of delivery 5 items, KERN DBS-A03S05, € 52,-
- Sample plates aluminium, ø 90 mm, unit of 80 pieces, KERN MLB-A01A, € 45,-
- Round fiberglass filter, medium mechanical stability, without organic binder, box of 100 pieces, KERN RH-A02, € 79,-
- Temperature calibration set consists of measuring sensor and display device, KERN DBS-A01, € 570,-
- USB 2.0 cable, KERN DBS-A04, € 28,-
- BalanceConnection software for flexible measured value recording or transmission, compatible with Microsoft® Excel, Access and other applications, Scope of supplies: Download link for 1 license, KERN SCD-4.0-DL, € 210,-
- Thermal printer, KERN YKH-01, € 420,-
- Matrix needle printer, to print the weights on normal paper, ideal for long-term archiving, KERN 911-013, € 480,-

5



Moisture analyser with intuitive graphic display and step-by-step user guidance in 6 languages

Features

- Backlit LCD graphic display, digit height 11 mm
- 6 direct keys for rapid access to the main functions
- Home screen:
 - 1 Main menu
 - 2 Start drying process
 - 3 Select drying temperature
 - 4 Select shut-off criteria

- 5 Setting to zero/taring
- 6 Stand-by
- During measurement:
 - 7 Current temperature
 - 8 Current heating profile
 - 9 Active switch-off criteria
 - 10 Abort drying process
 - 11 Stop drying process
 - 12 Display current drying parameters
 - 13 Toggle the unit for displaying the results

At the end of the measurement:

- 14 Exit drying program
- 15 Print measurement report
- 16 (De)activate, edit GLP parameters
- 17 Display detailed result
- 18 Toggle the unit for displaying the results
- 400 W halogen-quartz glass heater
- User guidance in 6 languages (DE, EN, FR, IT, ES, PT)
- Automatic taring when starting a measurement by closing the lid
- The last measured value remains visible in the display until the next measurement
- 19 Internal GLP; printout of balance ID, project ID, user ID, values determined by the drying process etc.
- 10 sample plates included
- Protective working cover included with delivery
- On the internet, you will find a practical application handbook containing many examples, field reports, settings and tips for each KERN moisture analyser

| | |
|--|------------------|
| STANDARD | OPTION |
| CAL EXT RS 232 GLP PRINTER UNIT 230 V DMS 1 DAY | DAKKS +3 DAYS |

| KERN | DLB 160-3A |
|--|--|
| Readability [d] Weight/Moisture (%) | 0,001 g / 0,01 % |
| Weighing capacity [Max] | 160 g |
| Reproducibility weight of sample 2 g* | 0,15 % |
| Reproducibility weight of sample 10 g* | 0,05 % |
| Display after drying (Display can be switched over at any time) | |
| Moisture [%] = Moisture content (M) from wet weight (W) | 0 - 100 % |
| Dry content [%] = Dry weight (D) from [W] | 100 - 0 % |
| ATRO [%] [(W-D) : D] · 100 % | 0 - 999 % |
| Moisture content (M) | Absolute value in [g] |
| Temperature range (in steps up to) | 35 °C - 160 °C (1 °C) |
| Drying modes | Standard drying Rapid drying, preheating can be switched on |
| Switch-off criteria | · Automatic unrestricted switch-off (Selectable loss in weight 0,01 mg/30 s - 10 mg/30 s) · Time controlled switch-off (1 min - 12 h) · Manual switch-off at the press of a button |
| Recall of measurement | Interval can be set from 5 s - 250 s |
| Overall dimensions W×D×H | 215×345×235 mm |
| Net weight | 4,7 kg |
| Price excl. of VAT ex works € | 1450,- |
| Option DAKKS Calibr. Certificate Mass | 963-127, € 103,- |
| Option Factory Calibr. Certificate Temperature | 964-305, € 174,- |

*application-dependent

Accessories

- Protective working cover, scope of delivery 5 items, KERN ALJ-A01S05, € 52,-
- Sample plates aluminium, ø 90 mm, unit of 80 pieces, KERN MLB-A01A, € 45,-
- Round fiberglass filter, medium mechanical stability, without organic binder, box of 100 pieces, KERN RH-A02, € 79,-
- Temperature calibration set consists of measuring sensor and display device KERN DLB-A01N., € 570,-
- Thermal printer, KERN YKH-01, € 420,-
- Matrix needle printer, to print the weights on normal paper, ideal for long-term archiving, KERN 911-013, € 480,-

6



BENCH SCALES

Compact industrial weighing technology

Thanks to their compact dimensions, low weight, robust internal mechanism and the fact that they can be operated independent of mains power, bench scales can be used not only in a stationary situation, but also as mobile scales.

With weighing ranges between 3 kg and 65 kg, bench scales can cover a wide range of applications. Whether as a commissioning scale in the warehouse, for inventory purposes, on a production work station, in quality control, in small workshops, in service cars or in sales offices, bench scales are the first choice.

Durable stainless steel weighing plates, easy to read backlit displays, useful functions such as piece counting, PRE-TARE – subtraction of a known container weight, or ► **interfaces** to PC and printer – all these support the users in their daily work.

► **Multi-division balances and multi-range balances** cover a particularly wide range of applications. With these scales, the total weighing range is divided into subranges and begins with a high resolution read-out in the fine weighing range. If this range is exceeded the balance automatically switches to the higher weighing range with the lower resolution read-out.

All KERN bench scales have an adjustment program (CAL) to adjust the accuracy. This way, the high level of accuracy is guaranteed at all times, even during harsh everyday use. See *Test weights*

► **See the Glossary**

Quick-Finder Bench Scales

| Readout | Weighing range | Weighing plate | Model | Price excl. of VAT | Page |  | | | | | | | | | |
|----------|----------------|----------------|--------------------|--------------------|------|--|---|---|---|---|---|---|---|---|--|
| [d] g | [Max] kg | W×D mm | KERN | ex works € | | For an explanation on the pictos, see the front flap | | | | | | | | | |
| 0,02 | 6 | 340×240 | FKB 6K0.02 | 530,- | 62 | ● | ○ | ● | ● | ● | ● | ● | ○ | ○ | |
| 0,05 | 6 | 252×225 | FCB 6K-5 | 330,- | 61 | ● | ○ | ● | ● | ● | ● | ● | ○ | ○ | |
| 0,05 | 8 | 340×240 | FKB 8K0.05 | 510,- | 62 | ● | ○ | ● | ● | ● | ● | ● | ○ | ○ | |
| 0,05 | 16 | 340×240 | FKB 16K0.05 | 550,- | 62 | ● | ○ | ● | ● | ● | ● | ● | ○ | ○ | |
| 0,1 | 8 | 252×225 | FCB 8K0.1 | 275,- | 61 | ● | ○ | ● | ● | ● | ● | ● | ○ | ○ | |
| 0,1 | 8 | 340×240 | FKB 8K0.1 | 360,- | 62 | ● | ○ | ● | ● | ● | ● | ● | ○ | ○ | |
| 0,1 | 12 | 252×225 | FCB 12K-4 | 330,- | 61 | ● | ○ | ● | ● | ● | ● | ● | ○ | ○ | |
| 0,1 | 16 | 340×240 | FKB 16K0.1 | 510,- | 62 | ● | ○ | ● | ● | ● | ● | ● | ○ | ○ | |
| 0,1 | 36 | 340×240 | FKB 36K0.1 | 560,- | 62 | ● | ○ | ● | ● | ● | ● | ● | ○ | ○ | |
| 0,2 | 30 | 252×225 | FCB 30K-4 | 330,- | 61 | ● | ○ | ● | ● | ● | ● | ● | ○ | ○ | |
| 0,2 | 36 | 340×240 | FKB 36K0.2 | 560,- | 62 | ● | ○ | ● | ● | ● | ● | ● | ○ | ○ | |
| 0,2 | 65 | 340×240 | FKB 65K0.2 | 540,- | 62 | ● | ○ | ● | ● | ● | ● | ● | ○ | ○ | |
| 0,5 | 15 | 340×240 | FKB 15K0.5 | 385,- | 62 | ● | ○ | ● | ● | ● | ● | ● | ○ | ○ | |
| 1 | 3 | 253×228 | FCE 3K1N | 135,- | 60 | ● | ○ | ● | ● | ● | ● | ● | ○ | ○ | |
| 1 | 12 | 252×225 | FCB 12K1 | 220,- | 61 | ● | ○ | ● | ● | ● | ● | ● | ○ | ○ | |
| 1 | 30 | 252×225 | FCB 30K1 | 260,- | 61 | ● | ○ | ● | ● | ● | ● | ● | ○ | ○ | |
| 1 | 30 | 340×240 | FKB 30K1 | 340,- | 62 | ● | ○ | ● | ● | ● | ● | ● | ○ | ○ | |
| 1 | 65 | 340×240 | FKB 65K1 | 360,- | 62 | ● | ○ | ● | ● | ● | ● | ● | ○ | ○ | |
| 1 2 | 3 6 | 252×225 | FCB 6K-3DM | 300,- | 61 | ○ | ○ | ○ | ○ | ○ | ○ | ○ | ○ | ○ | |
| 2 | 6 | 253×228 | FCE 6K2N | 135,- | 60 | ● | ○ | ● | ● | ● | ● | ● | ○ | ○ | |
| 2 5 | 6 15 | 252×225 | FCB 15K-3DM | 300,- | 61 | ○ | ○ | ○ | ○ | ○ | ○ | ○ | ○ | ○ | |
| 5 | 10 | 320×260 | ECE 10K-3N | 120,- | 59 | ● | ○ | ● | ● | ● | ● | ● | ○ | ○ | |
| 5 | 10 | 320×260 | ECB 10K-3N | 140,- | 59 | ● | ○ | ● | ● | ● | ● | ● | ○ | ○ | |
| 5 | 15 | 253×228 | FCE 15K5N | 135,- | 60 | ● | ○ | ● | ● | ● | ● | ● | ○ | ○ | |
| 5 10 | 15 30 | 252×225 | FCB 30K-3DM | 300,- | 61 | ○ | ○ | ○ | ○ | ○ | ○ | ○ | ○ | ○ | |
| 10 | 20 | 320×260 | ECE 20K-2N | 120,- | 59 | ● | ○ | ● | ● | ● | ● | ● | ○ | ○ | |
| 10 | 20 | 320×260 | ECB 20K-2N | 140,- | 59 | ● | ○ | ● | ● | ● | ● | ● | ○ | ○ | |
| 10 | 30 | 253×228 | FCE 30K10N | 135,- | 60 | ● | ○ | ● | ● | ● | ● | ● | ○ | ○ | |
| 20 | 50 | 320×260 | ECE 50K-2N | 120,- | 59 | ● | ○ | ● | ● | ● | ● | ● | ○ | ○ | |
| 20 | 50 | 320×260 | ECB 50K-2N | 140,- | 59 | ● | ○ | ● | ● | ● | ● | ● | ○ | ○ | |

News 2025

● Standard ○ Option



Plain, mobile, uncomplicated

Features

- Thanks to battery operation/rechargeable battery operation (optional), compact, light-weight construction, it is suitable for the use in several locations (production, warehouse, dispatch department, etc.)
- Particularly large weighing plate
- Very fast display: steady weight values within 2 s
- Simple and convenient 2-key operation

Technical data

1 KERN ECE

- Large LCD display, digit height 21 mm
- Dimensions weighing surface, plastic, W×D 320×260 mm
- Net weight approx. 1,6 kg

KERN ECB, see larger picture

- Large backlit LCD display, digit height 21 mm
- Dimensions weighing surface, stainless steel, W×D 320×260 mm
- Net weight approx. 2,6 kg

KERN ECE/ECB

- Overall dimensions W×D×H 320×300×60 mm
- Battery operation, 6×1.5 V AA standard, operating time up to 100 h, AUTO-OFF function to preserve the battery
- Permissible ambient temperature 5 °C/35 °C

Accessories

- Internal rechargeable battery pack, operating time up to 30 h without backlight, charging time approx. 10 h, KERN PCB-A01, **€ 90,-**
- Rechargeable battery pack external, operating time up to 30 h without backlight, charging time approx. 10 h, KERN KS-A01, **€ 180,-**
- Tare pan made from stainless steel, ideal for weighing loose small parts as well as fruits, vegetables, etc., overall dimensions W×D×H 400×300×45 mm, KERN RFS-A02, **€ 75,-**
- External universal mains adapter, with universal input and optional input socket adapters for EU, CH, GB, US, KERN YKA-03N, **€ 38,-**
- Further details, plenty of further accessories and suitable printers see *Accessories*

STANDARD



OPTION

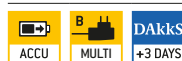

| Model | Weighing capacity [Max] kg | Readability [d] g | Reproducibility g | Linearity g | Price excl. of VAT ex works € | Options | |
|-------------------|----------------------------------|-------------------------|----------------------|----------------|--|---------------------------|--------------------|
| | | | | | | DAkkS Calibr. Certificate | DAkkS KERN € |
| KERN | | | | | | | |
| ECE 10K-3N | 10 | 5 | 5 | ± 20 | 120,- | 963-128 | 124,- |
| ECE 20K-2N | 20 | 10 | 10 | ± 40 | 120,- | 963-128 | 124,- |
| ECE 50K-2N | 50 | 20 | 20 | ± 80 | 120,- | 963-128 | 124,- |
| ECB 10K-3N | 10 | 5 | 5 | ± 20 | 140,- | 963-128 | 124,- |
| ECB 20K-2N | 20 | 10 | 10 | ± 40 | 140,- | 963-128 | 124,- |
| ECB 50K-2N | 50 | 20 | 20 | ± 80 | 140,- | 963-128 | 124,- |



6



Entry-level bench scale – mobile, practical, lightweight

Features

- Simple and convenient 2-key operation
- Very fast display: steady weight values within 3 s
- **1** Ideal as a compact letter and parcel scale, especially where space is limited
- **2** Ideal as a grading, commissioning or simple checkweighing scale in production or dispatch
- Protective working cover included with delivery

Technical data

- Large LCD display, digit height 25 mm
- Dimensions weighing surface, plastic, WxD 253x228 mm
- Overall dimensions WxDxH 270x323x110 mm
- Optional battery operation, 9 V block not included in scope of delivery, operating time up to 12 h, AUTO-OFF function to preserve the battery
- Net weight approx. 2,4 kg
- Permissible ambient temperature 5 °C/35 °C

Accessories

- Protective working cover, scope of delivery 5 items, KERN FCB-A02S05, **€ 52,-**
- **3** Stainless steel weighing plate, robust, removable, for easy cleaning, KERN FCE-A01, **€ 40,-**
- Internal rechargeable battery pack, operating time up to 20 h without backlight, charging time approx. 10 h, KERN FCB-A01, **€ 54,-**



| Model | Weighing capacity [Max] kg | Readability [d] g | Reproducibility g | Linearity g | Price excl. of VAT ex works € | Options | |
|------------|----------------------------------|-------------------------|----------------------|----------------|--|--|--------------------------------|
| | | | | | | DAkkS Calibr. Certificate DAkkS KERN | DAkkS Calibr. Certificate € |
| FCE 3K1N | 3 | 1 | 2 | ± 3 | 135,- | 963-127 | 103,- |
| FCE 6K2N | 6 | 2 | 2 | ± 4 | 135,- | 963-128 | 124,- |
| FCE 15K5N | 15 | 5 | 10 | ± 15 | 135,- | 963-128 | 124,- |
| FCE 30K10N | 30 | 10 | 10 | ± 30 | 135,- | 963-128 | 124,- |



The new FCB: Checkweighing and portioning scale with up to three interfaces, with optional verification

Features

- Standardised, convenient KERN concept of operation, consistency across products in terms of design, menu structure, button functions, interface connection and interface protocol
- Compact size
- KERN Universal Port (KUP): permits the connection of an external KUP interface adapter, such as, for example, RS-232, USB, Bluetooth, WiFi or Ethernet, for the exchange of data and control commands, without any installation outlay. Available as an option: RS-232, USB, Ethernet, WiFi, Bluetooth

- KERN Communication Protocol (KCP): The KCP permits searching and remote control of the balance using external control devices or computers. For further information on KUP and KCP see page 18/19
- Thanks to battery operation/rechargeable battery operation (optional), compact, lightweight construction, it is suitable for the use in several locations
- Weighing with tolerance range: a visual and audible signal helps with portioning, dispensing or grading
- Summation of weight values
- Protective working cover included with delivery

Technical data

- Backlit LCD display, digit height 25 mm
- Dimensions weighing surface, stainless steel, WxD 252x225 mm
- Overall dimensions WxDxH 322x267x91 mm
- Net weight approx. 3,8 kg
- Permissible ambient temperature
KERN FCB: 0 °C/40 °C
KERN FCB-M: -10 °C/40 °C

Accessories

- Protective working cover, scope of delivery 5 items, KERN YBA-A14S05, € 52,-
- Internal rechargeable battery pack, operating time up to 48 h without backlight, charging time approx. 8 h, KERN YKR-01, € 35,-
- Signal lamp for visual support of weighing with tolerance range. connection is only possible in combination with KUP-01 (RS-232 interface), KERN CFS-A03, € 310,-
- External data interface RS-232, interface cable included, KERN KUP-01, € 60,-
- External data interface USB, interface cable included, KERN KUP-03, € 75,-
- Ethernet interface adapter, KERN KUP-04, € 115,-
- WiFi interface adapter, KERN KUP-05, € 75,-
- Bluetooth interface adapter, KERN KUP-06, € 99,-
- Extension box for connecting up to three interfaces in parallel, KERN KUP-13, € 75,-
- Further details, plenty of further accessories and suitable printers see *Accessories*

STANDARD

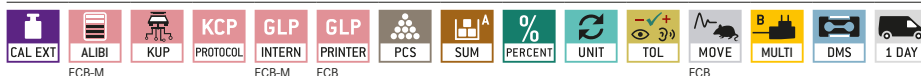

OPTION



FACTORY



| Model | Weighing capacity [Max] kg | Readability [d] g | Verification value [e] g | Minimal load [Min] g | Smallest part weight (Normal) g/piece | Price excl. of VAT ex works € | Options | | | |
|----------------|----------------------------|-------------------|--------------------------|----------------------|---------------------------------------|-------------------------------|--------------|---|---------|---------------------|
| | | | | | | | Verification | € | DAkkS | Calibr. Certificate |
| KERN FCB 6K-5 | 6 | 0,05 | - | - | 0,5 | 330,- | - | - | 963-128 | 124,- |
| KERN FCB 8K0.1 | 8 | 0,1 | - | - | 1 | 275,- | - | - | 963-128 | 124,- |
| KERN FCB 12K-4 | 12 | 0,1 | - | - | 1 | 330,- | - | - | 963-128 | 124,- |
| KERN FCB 12K1 | 12 | 1 | - | - | 10 | 220,- | - | - | 963-128 | 124,- |
| KERN FCB 30K-4 | 30 | 0,2 | - | - | 2 | 330,- | - | - | 963-128 | 124,- |
| KERN FCB 30K1 | 30 | 1 | - | - | 10 | 260,- | - | - | 963-128 | 124,- |

Multi-division balance, with increasing or decreasing load, it switches automatically to the next largest or smallest weighing range [Max] and readout [d].

| | | | | | | | | | | |
|------------------|---------|--------|--------|-----|----|-------|---------|------|---------|-------|
| KERN FCB 6K-3DM | 3 6 | 1 2 | 1 2 | 20 | 2 | 300,- | 965-228 | 84,- | 963-128 | 124,- |
| KERN FCB 15K-3DM | 6 15 | 2 5 | 2 5 | 40 | 5 | 300,- | 965-228 | 84,- | 963-128 | 124,- |
| KERN FCB 30K-3DM | 15 30 | 5 10 | 5 10 | 100 | 10 | 300,- | 965-228 | 84,- | 963-128 | 124,- |

Note: For devices that require verification (conformity assessment according to NAWI 2014/31/EU), please include the verification when placing your order. The initial verification is not possible after delivery. Please inform the full address of the location of use for the initial verification.

New model



Technical data

- Large backlit LCD display, digit height 25 mm
- Dimensions weighing surface, stainless steel, WxD 340x240 mm
- Overall dimensions WxDxH, 350x390x120 mm
- Optional battery operation, 4x1.5 V AA not included in scope of delivery, operating time up to 20 h
- Net weight approx. 7 kg
- Permissible ambient temperature -10 °C/40 °C

Accessories

- Protective working cover, scope of delivery 5 items, KERN FKB-A02S05, **€ 52,-**
- Internal rechargeable battery pack, operating time up to 48 h without backlight, charging time approx. 8 h, KERN YKR-01, **€ 35,-**
- Schnittstellenadapter USB, KERN KUP-03, **€ 75,-**
- Schnittstellenadapter RS-232, KERN KUP-01, **€ 60,-**
- Bluetooth interface adapter, KERN KUP-06, **€ 99,-**
- WiFi interface adapter, KERN KUP-05, **€ 75,-**
- Ethernet interface adapter, KERN KUP-04, **€ 115,-**
- Extension box for connecting up to three interfaces in parallel, KERN KUP-13, **€ 75,-**
- Tare pan made from stainless steel, ideal for weighing loose small parts as well as fruits, vegetables, etc., overall dimensions WxDxH 400x300x45 mm, KERN RFS-A02, **€ 75,-**
- Further details, plenty of further accessories and suitable printers see *Accessories*



High resolution bench scale with large weighing range and robust stainless steel weighing plate

Features

- Thanks to the high resolution of up to 360.000 points it is ideal for high-precision weighing in the industrial field
- Robust plastic die-cast housing: maintains the stability, protects the weighing technology elements and is robust enough to cope with everyday use
- KERN Universal Port (KUP): permits the connection of an external KUP interface adapter, such as, for example, RS-232, USB, Bluetooth, WiFi or Ethernet, for the exchange of data and control commands, without any installation outlay
- KERN Communication Protocol (KCP): The KCP permits searching and remote control of the balance using external control devices or computers
- PRE-TARE function for manual subtraction of a known container weight, useful for checking fill-levels
- Freely programmable weighing unit, e.g. display direct in special units such as length of wire g/m, surface weight g/m², or else
- Level indicator and levelling feet for precise levelling of the scale, fitted as standard
- Protective working cover included with delivery

STANDARD



OPTION



| Model | Weighing capacity [Max] kg | Readability [d] g | Reproducibility g | Linearity g | Smallest part weight (Normal) g/piece | Resolution Points | Price excl. of VAT ex works € | Options | |
|------------------|----------------------------|-------------------|-------------------|-------------|---------------------------------------|-------------------|-------------------------------|------------|-----------------------|
| | | | | | | | | DAkkS KERN | Calibr. Certificate € |
| KERN FKB 6K0.02 | 6 | 0,02 | 0,04 | ± 0,1 | 0,2 | 300.000 | 530,- | 963-128 | 124,- |
| KERN FKB 8K0.05 | 8 | 0,05 | 0,05 | ± 0,15 | 0,5 | 160.000 | 510,- | 963-128 | 124,- |
| KERN FKB 16K0.05 | 16 | 0,05 | 0,1 | ± 0,25 | 0,5 | 320.000 | 550,- | 963-128 | 124,- |
| KERN FKB 8K0.1 | 8 | 0,1 | 0,1 | ± 0,3 | 1 | 80.000 | 360,- | 963-128 | 124,- |
| KERN FKB 16K0.1 | 16 | 0,1 | 0,1 | ± 0,3 | 1 | 160.000 | 510,- | 963-128 | 124,- |
| KERN FKB 15K0.5 | 15 | 0,5 | 0,5 | ± 1,5 | 10 | 30.000 | 385,- | 963-128 | 124,- |
| KERN FKB 36K0.1 | 36 | 0,1 | 0,2 | ± 0,5 | 1 | 360.000 | 560,- | 963-128 | 124,- |
| KERN FKB 36K0.2 | 36 | 0,2 | 0,4 | ± 1 | 2 | 180.000 | 560,- | 963-128 | 124,- |
| KERN FKB 65K0.2 | 65 | 0,2 | 0,4 | ± 1 | 2 | 325.000 | 540,- | 963-129 | 153,- |
| KERN FKB 30K1 | 30 | 1 | 1 | ± 3 | 20 | 30.000 | 340,- | 963-128 | 124,- |
| KERN FKB 65K1 | 65 | 1 | 1 | ± 3 | 20 | 65.000 | 360,- | 963-129 | 153,- |

7



FOOD (KITCHEN, STAINLESS STEEL, IP65...68 PROTECTION)

KERN scales – without fear of water!

Scales used in industrial situations or the food industry are often exposed to extreme stresses and strains. Water, oils, fats, varnish, dust, dirt, flour, small parts etc. are all natural enemies of a scale. In industries such as the food, chemical, manufacturing industries, etc., scales must be able to cope with these stressors without it affecting their performance.

For use in such harsh environmental conditions, levels of protection are defined, which specify which environmental stressors a system can be exposed to with respect to the level of contact, foreign object and moisture protection, without damage being caused to the unit.

These levels of protection are described in the following standard: “DIN EN 60529: protection types through housing” The IP code usually consists of a two-digit combination, which gives the relevant level of protection, e.g. IP68. The first digit specifies the protection level for contact protection and protection against foreign bodies (dust protection), the second digit is for the water and moisture protection (protection against splashes of water).

All stainless steel components of the IP65...68 protected KERN stainless steel scales are made of corrosion-resistant steel of quality class 1.4301 (DIN X5CrNi18-10). The material properties support you in your ► **HACCP**-compliant quality system.

► [See the Glossary](#)

Extract from the standard: “DIN EN 60529: protection types through housing”:









| KERN-Pictogram | 1. digit | Specification | 2. digit | Specification |
|----------------|----------|---------------|----------|---|
| | 6 | Dustproof | 5 | Protection against jets of water (nozzle) from any angle (cleaning with a damp cloth) |
| | 6 | Dustproof | 6 | Protection against powerful jets of water |
| | 6 | Dustproof | 7 | Protection against temporary immersion |
| | 6 | Dustproof | 8 | Protection against continuous immersion (designed for continuous use in wet areas, submersion is possible depending on the pressure (water depth) |

Quick-Finder Food (kitchen/stainless steel/IP65...68 protection)

| Readout | Weighing range [Max] | Model | Price excl. of VAT ex works | Page | | | | | | | | | |
|---------|----------------------|---------------|-----------------------------|------|--|---|---|---|---|---|---|---|-----|
| [d] | kg | KERN | € | | For an explanation on the pictos, see the front flap | | | | | | | | |
| 0,1 | 0,5 | FOB 500-1S | 90,- | 69 | ● | | | | | | | | ● |
| 0,1 | 0,5 | FOB 0.5K-4NS | 125,- | 69 | ● | | | | ● | | | | ● |
| 0,1 | 3 | FCF 3K-4 | 220,- | 67 | ● | | | | | | | | ● ○ |
| 0,2 | 1,5 | WTB 1K-4N | 285,- | 71 | ● | | | ● | | | | | ○ |
| 0,2 | 1,5 | FFN 1K-4N | 325,- | 72 | ● | | | | ● | | | | ● |
| 0,2 | 3 | FOB 3K-4NL | 330,- | 70 | ● | | | | | ● | | | ● |
| 0,5 | 1,5 | FOB 1K-4LM | 335,- | 68 | ○ | ● | | | ● | | | | ● |
| 0,5 | 1,5 | FOB 1.5K0.5 | 240,- | 70 | ● | | | | ● | | | | ○ |
| 0,5 | 1,5 | WTB 1K-4NM | 300,- | 71 | ○ | ● | | | ● | | | | ○ |
| 0,5 | 1,5 | FFN 1K-4NM | 340,- | 72 | ○ | ● | | | ● | | | | ● |
| 0,5 | 3 | WTB 3K-4N | 285,- | 71 | ● | | | | ● | | | | ○ |
| 0,5 | 3 | FFN 3K0.5IPN | 325,- | 72 | ● | | | | ● | | | | ● |
| 0,5 | 3 | FXN 3K-4N | 460,- | 73 | ● | | | | | | ● | | ● |
| 0,5 | 6 | SXC 6K-4 | 1220,- | 74 | ● | ○ | | ● | | | ● | | ○ |
| 0,5 1 | 5 7,5 | FOB 7K-4NL | 295,- | 70 | ● | | | | | ● | | | ● |
| 1 | 3 | FOB 3K-3LM | 340,- | 68 | ○ | ● | | | ● | | | | ● |
| 1 | 3 | FOB 3K1 | 240,- | 70 | ● | | | | ● | | | | ○ |
| 1 | 3 | WTB 3K-3NM | 300,- | 71 | ○ | ● | | | ● | | | | ○ |
| 1 | 3 | FFN 3K1IPM | 340,- | 72 | ○ | ● | | | ● | | | | ● |
| 1 | 3 | FXN 3K-3M | 490,- | 73 | ○ | ● | | | | | ● | | ● |
| 1 | 5 | FGE 5K-3S05 | 115,- | 66 | ● | | | | | | | | ● |
| 1 | 5 | FOB 5K1S | 90,- | 69 | ● | | | | | | | | ● |
| 1 | 5 | FOB 5K-3NS | 125,- | 69 | ● | | | | ● | | | | ● |
| 1 | 6 | WTB 6K-3N | 285,- | 71 | ● | | | ● | | | | | ○ |
| 1 | 6 | FFN 6K1IPN | 325,- | 72 | ● | | | | ● | | | | ● |
| 1 | 6 | FXN 6K-3N | 460,- | 73 | ● | | | | | | ● | | ● |
| 1 | 10 | SFB 10K1HIP | 850,- | 76 | ● | ○ | | ● | | | | | ● |
| 1 | 15 | FGE 10K-3S05 | 170,- | 66 | ● | | | | | | | | ● |
| 1 | 15 | SXC 10K-3 | 1220,- | 74 | ● | ○ | | ● | | | ● | | ○ |
| 1 | 15 | SXC 10K-3L | 1270,- | 74 | ● | ○ | | ● | | | ● | | ○ |
| 1 | 30 | FCF 30K-3 | 220,- | 67 | ● | | | | | | | ● | ○ |
| 1 2 | 3 6 | SXC 6K-3M | 1130,- | 74 | ○ | ● | ○ | ● | | | ● | | ○ |
| 1 2 | 8 15 | FOB 10K-3NL | 295,- | 70 | ● | | | | | ● | | | ● |
| 2 | 6 | FOB 6K-3LM | 335,- | 68 | ○ | ● | | | ● | | | | ● |
| 2 | 6 | FOB 6K2 | 240,- | 70 | ● | | | | ● | | | | ○ |
| 2 | 6 | WTB 6K-3NM | 300,- | 71 | ○ | ● | | | ● | | | | ○ |
| 2 | 6 | FFN 6K2IPM | 340,- | 72 | ○ | ● | | | ● | | | | ● |
| 2 | 6 | FXN 6K-3M | 490,- | 73 | ○ | ● | | | | | ● | | ● |
| 2 | 15 | WTB 10K-3N | 285,- | 71 | ● | | | | ● | | | | ○ |
| 2 | 15 | FFN 15K2IPN | 325,- | 72 | ● | | | | ● | | | | ● |
| 2 | 15 | FXN 10K-3N | 460,- | 73 | ● | | | | | | ● | | ● |
| 2 | 20 | SFB 20K2HIP | 850,- | 76 | ● | ○ | | ● | | | | | ● |
| 2 | 30 | SXC 30K-3 | 1220,- | 74 | ● | ○ | | ● | | | ● | | ○ |
| 2 | 30 | SXC 30K-3L | 1280,- | 74 | ● | ○ | | ● | | | ● | | ○ |
| 2 5 | 6 15 | SXC 10K-3M | 1130,- | 74 | ○ | ● | ○ | ● | | | ● | | ○ |
| 2 5 | 6 15 | SXC 10K-3LM | 1180,- | 74 | ○ | ● | ○ | ● | | | ● | | ○ |
| 2 5 | 16 30 | FOB 30K-3NL | 295,- | 70 | ● | | | | | ● | | | ● |
| 5 | 15 | FOB 10K-3LM | 335,- | 68 | ○ | ● | | | ● | | | | ● |
| 5 | 15 | WTB 10K-3NM | 300,- | 71 | ○ | ● | | | ● | | | | ○ |
| 5 | 15 | FFN 15K5IPM | 340,- | 72 | ○ | ● | | | ● | | | | ● |
| 5 | 15 | FXN 10K-3M | 490,- | 73 | ○ | ● | | | | | ● | | ● |
| 5 | 15 | SFB 15K5HIPM | 870,- | 76 | ○ | ● | ○ | ● | | | | | ● |
| 5 | 25 | FFN 25K5IPN | 325,- | 72 | ● | | | | ● | | | | ● |
| 5 | 30 | WTB 30K-3N | 285,- | 71 | ● | | | | ● | | | | ○ |
| 5 | 30 | FXN 30K-3N | 460,- | 73 | ● | | | | | | ● | | ● |
| 5 | 50 | SFB 50K5LHIP | 820,- | 76 | ● | ○ | | ● | | | | | ● |
| 5 | 50 | SFB 50K5HIP | 850,- | 76 | ● | ○ | | ● | | | | | ● |
| 5 | 50 | SFB 50K-3XL | 970,- | 76 | ● | ○ | | ● | | | | | ● |
| 5 | 60 | SXC 60K-3 | 1220,- | 74 | ● | ○ | | ● | | | ● | | ○ |
| 5 | 60 | SXC 60K-3L | 1280,- | 74 | ● | ○ | | ● | | | ● | | ○ |
| 5 10 | 15 30 | SXC 30K-3M | 1130,- | 74 | ○ | ● | ○ | ● | | | ● | | ○ |
| 5 10 | 15 30 | SXC 30K-3LM | 1180,- | 74 | ○ | ● | ○ | ● | | | ● | | ○ |
| 10 | 25 | FFN 25K10IPM | 340,- | 72 | ○ | ● | | | ● | | | | ● |
| 10 | 30 | WTB 30K-2NM | 300,- | 71 | ○ | ● | | | ● | | | | ○ |
| 10 | 30 | FXN 30K-2M | 490,- | 73 | ○ | ● | | | | | ● | | ● |
| 10 | 30 | SFB 30K10HIPM | 870,- | 76 | ○ | ● | ○ | ● | | | | | ● |
| 10 | 100 | SFB 100K10HIP | 880,- | 76 | ● | ○ | | ● | | | | | ● |
| 10 | 100 | SFB 100K-2XL | 1430,- | 76 | ● | ○ | | ● | | | | | ● |
| 10 | 150 | SXC 100K-2 | 1220,- | 74 | ● | ○ | | ● | | | ● | | ○ |
| 10 | 150 | SXC 100K-2L | 1410,- | 74 | ● | ○ | | ● | | | ● | | ○ |
| 10 20 | 30 60 | SXC 60K-2M | 1130,- | 74 | ○ | ● | ○ | ● | | | ● | | ○ |

● Standard ○ Option

Quick-Finder Food (kitchen/stainless steel/IP65...68 protection)

| Readout | Weighing range | Model | Price excl. of VAT ex works | Page |  |  |  |  |  |  |  |  |  |
|----------|----------------|-----------------------|-----------------------------|------|---|--|---|---|---|---|---|---|---|
| [d] | [Max] | KERN | € | | For an explanation on the pictos, see the front flap | | | | | | | | |
| g | kg | | | | | | | | | | | | |
| 10 20 | 30 60 | SXC 60K-2LM | 1 180,- | 74 | <input type="radio"/> | <input checked="" type="radio"/> | <input type="radio"/> | <input checked="" type="radio"/> | <input type="radio"/> | <input type="radio"/> | <input type="radio"/> | <input checked="" type="radio"/> | <input type="radio"/> |
| 20 | 60 | SFB 60K20LHIPM | 890,- | 76 | <input type="radio"/> | <input checked="" type="radio"/> | <input type="radio"/> | <input checked="" type="radio"/> | <input type="radio"/> | <input type="radio"/> | <input type="radio"/> | <input type="radio"/> | <input checked="" type="radio"/> |
| 20 | 60 | SFB 60K-2XLM | 1 130,- | 76 | <input type="radio"/> | <input checked="" type="radio"/> | <input type="radio"/> | <input checked="" type="radio"/> | <input type="radio"/> | <input type="radio"/> | <input type="radio"/> | <input type="radio"/> | <input checked="" type="radio"/> |
| 20 | 300 | SXC 300K-2 | 1 500,- | 74 | <input type="radio"/> | <input checked="" type="radio"/> | <input type="radio"/> | <input checked="" type="radio"/> | <input type="radio"/> | <input type="radio"/> | <input checked="" type="radio"/> | <input type="radio"/> | <input type="radio"/> |
| 20 50 | 60 150 | SXC 100K-2M | 1 130,- | 74 | <input type="radio"/> | <input checked="" type="radio"/> | <input type="radio"/> | <input checked="" type="radio"/> | <input type="radio"/> | <input type="radio"/> | <input checked="" type="radio"/> | <input type="radio"/> | <input type="radio"/> |
| 20 50 | 60 150 | SXC 100K-2LM | 1 310,- | 74 | <input type="radio"/> | <input checked="" type="radio"/> | <input type="radio"/> | <input checked="" type="radio"/> | <input type="radio"/> | <input type="radio"/> | <input checked="" type="radio"/> | <input type="radio"/> | <input type="radio"/> |
| 50 | 150 | SFB 100K-2HM | 910,- | 76 | <input type="radio"/> | <input checked="" type="radio"/> | <input type="radio"/> | <input checked="" type="radio"/> | <input type="radio"/> | <input type="radio"/> | <input checked="" type="radio"/> | <input type="radio"/> | <input checked="" type="radio"/> |
| 50 | 150 | SFB 100K-2LM | 1 210,- | 76 | <input type="radio"/> | <input checked="" type="radio"/> | <input type="radio"/> | <input checked="" type="radio"/> | <input type="radio"/> | <input type="radio"/> | <input checked="" type="radio"/> | <input type="radio"/> | <input checked="" type="radio"/> |
| 50 | 150 | SFB 100K-2XLM | 1 450,- | 76 | <input type="radio"/> | <input checked="" type="radio"/> | <input type="radio"/> | <input checked="" type="radio"/> | <input type="radio"/> | <input type="radio"/> | <input checked="" type="radio"/> | <input type="radio"/> | <input checked="" type="radio"/> |
| 50 100 | 150 300 | SXC 300K-2M | 1 410,- | 74 | <input type="radio"/> | <input checked="" type="radio"/> | <input type="radio"/> | <input checked="" type="radio"/> | <input type="radio"/> | <input type="radio"/> | <input checked="" type="radio"/> | <input type="radio"/> | <input type="radio"/> |

● Standard ○ Option

SET
5x



1 FGE 5K-3S05

2 FGE 10K-3S05



7

Precise design kitchen scale for kitchen, cafeteria, gastronomy

Features

- FGE 10K-3S05: Weighing plate made out of safety glass
- Easy and hygienic cleaning
- Low overall height for secure footing and space-saving storage
- Secure and non-slip positioning with rubber feet
- Very easy to use
 - 1 FGE 5K-3S05: 2 Buttons
 - 2 FGE 10K-3S05: 1 Button
- Comfortable taring with just one keystroke. For example, you can tare a bowl before starting a formulation. In addition, you can tare each time you weigh in a formulation ingredient, so that you can weigh in the next formulation ingredient with the weight indicated in the formula without having to do any calculations
- Integrated AUTO-OFF function to preserve the batteries
- Large high-contrasted display that is easy to read
- 3 Delivered in single design packaging

Technical data

1 FGE 5K-3S05

- Large backlit LCD display, Digit height 18 mm
- Overall dimensions W×D×H 152×230×15 mm
- Dimensions weighing surface, acrylic, W×D 152×230 mm
- Ready for use: Batteries included, 2×CR2032

2 FGE 10K-3S05

- Large, luminescent LED segments display, Digit height 22 mm
- Overall dimensions W×D×H 272×250×22 mm
- Dimensions weighing surface, glass, W×D 272×205 mm
- Ready for use: Batteries included, 3×1.5 V AAA

Note: The models with the suffix -S05 are delivered in a set of 5 units. i.e. the price given in the table refers to 5 items. Cannot be delivered individually

STANDARD



OPTION



| Model | Weighing capacity [Max] kg | Readability [d] g | Price excl. of VAT ex works € | Options | |
|--------------|----------------------------------|-------------------------|--|---------------|--------------------------------|
| | | | | DAkKS KERN | DAkKS Calibr. Certificate € |
| FGE 5K-3S05 | 5 | 1 | 115,- | 963-127S05 | 515,- |
| FGE 10K-3S05 | 15 | 1 | 170,- | 963-128S05 | 620,- |



Compact bench scale with multi-purpose functionality and a high level of accuracy for use in industry, gastronomy and kitchen

Features

- Ideal as a
 - Checkweigher in the catering trade, cafeterias, school kitchens
 - compact letter and parcel scale, especially in constricted spaces
 - grading or commissioning balance or simple checkweigher in production or dispatch
- Simple and convenient 5-key operation
- Very fast display: steady weight values within 3 s
- Thanks to battery operation/rechargeable battery operation (optional), compact, lightweight construction, it is suitable for the use in several locations (production, warehouse, dispatch department, etc.)
- Protective working cover included with delivery

Technical data

- Large backlit LCD display, digit height 25 mm
- Dimensions weighing surface, stainless steel, WxD 253x228 mm
- Overall dimensions WxDxH 270x345x106 mm
- Optional battery operation, 9 V block not included in scope of delivery, operating time up to 20 h. AUTO-OFF function to preserve the battery
- Net weight approx. 2,8 kg
- Permissible ambient temperature 5 °C/35 °C

Accessories

- Protective working cover, scope of delivery 5 items, KERN FCF-A01S05, € 52,-
- Internal rechargeable battery pack, operating time up to 120 h without backlight, charging time approx. 16 h, KERN GAB-A04, € 42,-

STANDARD



OPTION



| Model | Weighing capacity [Max] kg | Readability [d] g | Reproducibility g | Linearity g | Smallest part weight (Normal) g/piece | Price excl. of VAT ex works € | Options | |
|------------------|----------------------------------|-------------------------|----------------------|----------------|--|--|---------------|--------------------------------|
| | | | | | | | DAkKS KERN | DAkKS Calibr. Certificate € |
| KERN | | | | | | | | |
| FCF 3K-4 | 3 | 0,1 | 0,1 | ± 0,3 | 2 | 220,- | 963-127 | 103,- |
| FCF 30K-3 | 30 | 1 | 1 | ± 3 | 20 | 220,- | 963-128 | 124,- |



7

Compact stainless steel bench scale with special checkweighing display for even more efficient working, verification optional

Features

- **1** Innovative weighing with tolerance range: The colour of the display changes depending on the weight (too light/ok/too heavy) and is an aid to help with portioning, dosing and grading
- Thanks to the stainless steel design of the housing and platform with smooth surface, the scale is rust-free and easy to clean
- **2** Ideal for the increased hygienic requirements in the food industries
- Thanks to battery operation, compact, light-weight construction, it is suitable for the use in several locations (kitchens, sales offices, cafeterias, food industry laboratories, etc.)
- Your support in a HACCP-compliant quality system

- Protection against dust and water splashes IP65 (only when using battery)
- Increased protection against humidity through waterproof silicone sealing of the load cell, electronics and soldering joints
- Secure and non-slip positioning with rubber feet
- Mains adapter included with the delivery
- Protective working cover included with delivery

Technical data

- Large backlit LCD display, digit height 25 mm
- Dimensions weighing surface, stainless steel, W×D 248×198 mm
- Overall dimensions W×D×H 256×285×100 mm
- Battery operation, 4×1.5 V AA standard, operating time up to 48 h. AUTO-OFF function to preserve the battery
- Net weight approx. 3,8 kg
- Permissible ambient temperature 0 °C/40 °C

Accessories

- **3** Protective working cover, scope of delivery 5 items, KERN FOB-A13S05, **€ 52,-**
- **4** Tare pan made from stainless steel, ideal for weighing loose small parts as well as fruits, vegetables, etc., overall dimensions W×D×H 400×300×45 mm, KERN RFS-A02, **€ 75,-**



Note: Official verification is mandatory for commercial trade

| Model | Weighing capacity [Max] kg | Readability [d] g | Verification value [e] g | Minimal load [Min] g | Price excl. of VAT ex works € | Options | | | |
|-------------|----------------------------------|-------------------------|--------------------------------|----------------------------|--|--------------|------|---------------------------|-------|
| | | | | | | Verification | | DAkkS Calibr. Certificate | |
| KERN | | | | | | M KERN | € | DAkkS KERN | € |
| FOB 1K-4LM | 1,5 | 0,5 | 0,5 | 10 | 335,- | 965-227 | 65,- | 963-127 | 103,- |
| FOB 3K-3LM | 3 | 1 | 1 | 20 | 340,- | 965-227 | 65,- | 963-127 | 103,- |
| FOB 6K-3LM | 6 | 2 | 2 | 40 | 335,- | 965-228 | 84,- | 963-128 | 124,- |
| FOB 10K-3LM | 15 | 5 | 5 | 100 | 335,- | 965-228 | 84,- | 963-128 | 124,- |

Note: For devices that require verification (conformity assessment according to NAWI 2014/31/EU), please include the verification when placing your order. The initial verification is not possible after delivery. Please inform the full address of the location of use for the initial verification.



FOB-S



FOB-NS



Compact stainless steel balance for weighing, checking and portioning in the smallest of spaces

Features

- Thanks to the stainless steel design of the housing and platform with smooth surface, the scale is rust-free and easy to clean
- High mobility: thanks to battery operation, compact, lightweight construction, it is suitable for the use in several locations (kitchen, sales office, cafeteria, food industry-laboratory etc.)
- Secure and non-slip positioning with rubber feet
- Protection against dust and water splashes IP65 (only when using battery)
- Your support in a HACCP-compliant quality system
- Particularly flat design
- Protective working cover included with delivery

Accessories

- External mains adapter, KERN YKA-46, € 45,-

FOB-S

- Protective working cover, scope of delivery 5 items, KERN FOB-A12S05, € 52,-

FOB-NS

- Protective working cover, scope of delivery 5 items, KERN FOB-A11S05, € 52,-

STANDARD



FOB-NS

OPTION



| Model KERN | FOB 500-1S | FOB 5K1S | FOB 0.5K-4NS | FOB 5K-3NS |
|---|------------------|----------|------------------|---------------|
| Weighing capacity [Max] g | 500 | 5000 | 500 | 5000 |
| Readability [d] g | 0,1 | 1 | 0,1 | 1 |
| Display without backlight, digit height | LCD, 20 mm | | LCD, 20 mm | |
| Dimensions of weighing surface W×D | 125×155 mm | | 120×150 mm | |
| Overall dimensions W×D×H | 155×175×40 mm | | 150×170×40 mm | |
| Batteries included with delivery | 9 V block | | 9 V block | |
| Operating time up to | 20 h | | 20 h | |
| Net weight | 0,70 kg | | 0,80 kg | |
| Permissible ambient temperature | 10 °C - 40 °C | | 10 °C - 35 °C | 10 °C - 40 °C |
| Price, excl. of VAT, ex works, € | 90,- | | 125,- | |
| Option DAKKS Calibr. Certificate | 963-127, € 103,- | | 963-127, € 103,- | |



FOB



FOB-NL



7

Compact stainless steel balance with large weighing range

Features

- KERN FOB: Innovative weighing with tolerance range: The colour of the display changes depending on the weight (too light/ok/too heavy) and is an aid to help with portioning, dosing and grading
- KERN FOB-NL: Protection against dust and water splashes IP67 (only when using battery)
- Thanks to the stainless steel design of the housing and platform with smooth surface, the scale is rust-free and easy to clean

- Increased protection against humidity through waterproof silicone sealing of the load cell, electronics and soldering joints
- Your support in a HACCP-compliant quality system
- Ideal for the increased hygienic requirements in the food industries
- Thanks to battery operation/rechargeable battery operation (optional), compact, lightweight construction, it is suitable for the use in several locations
- Secure and non-slip positioning with rubber feet

Accessories

- Tare pan made from stainless steel, ideal for weighing loose small parts as well as fruits, vegetables, etc., overall dimensions W×D×H 400×300×45 mm, KERN RFS-A02, **€ 75,-**

FOB

- Protective working cover, scope of delivery: 5 items, KERN FOB-A05S05, **€ 52,-**
- Internal rechargeable battery pack, operating time up to 24 h without backlight, charging time approx. 8 h, KERN FOB-A07, **€ 60,-**

FOB-NL

- Protective working cover, scope of delivery: 5 items, KERN FOB-A13S05, **€ 52,-**
- External mains adapter, KERN YKA-29, **€ 43,-**

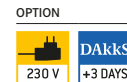
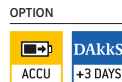

| Model KERN | FOB 1.5K0.5 | FOB 3K1 | FOB 6K2 | FOB 3K-4NL | FOB 7K-4NL | FOB 10K-3NL | FOB 30K-3NL |
|--|-------------------|------------------|------------------|--|------------------|------------------|------------------|
| Weighing capacity [Max] kg | 1,5 | 3 | 6 | 3 | 5 7,5 | 8 15 | 16 30 |
| Readability [d] g | 0,5 | 1 | 2 | 0,2 | 0,5 1 | 1 2 | 2 5 |
| LCD display backlight, digit height | yes, 20 mm | | | no, 25 mm | | yes, 25 mm | |
| Dimensions of weighing surface W×D | 175×165 mm | | | 252×200 mm | | | |
| Overall dimensions W×D×H | 235×175×55 mm | | 243×183×54 mm | 285×255×90 mm | | | |
| Power supply | Power supply unit | | | Battery, 4×1.5 V AA, operating time up to 48 h | | | |
| Net weight | 1,8 kg | 2,0 kg | | 3,8 kg | | | |
| Permissible ambient temperature | 5 °C – 35 °C | | | 5 °C – 35 °C | | | |
| Price, excl. of VAT, ex works, € | 240,- | 240,- | 240,- | 330,- | 295,- | 295,- | 295,- |
| Option DAkkS Calibr. Certificate | 963-127, € 103,- | 963-127, € 103,- | 963-128, € 124,- | 963-127, € 103,- | 963-128, € 124,- | 963-128, € 124,- | 963-128, € 124,- |

*Multi-division balance, with increasing or decreasing load, it switches automatically to the next largest or smallest weighing range [Max] and readout [d].

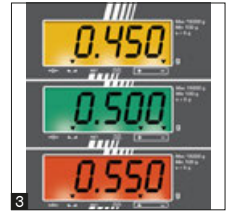

Ideal for food industry, thanks to its IP65 protection and special checkweighing display, verification optional

Features

- Ideal for the increased hygienic requirements in the food industries
- Your support in a HACCP-compliant quality system
- **1** Protection against dust and water splashes IP65 (only when using rechargeable battery pack)
- Very fast display: steady weight values within 2 s
- **2** Second display on the back of the balance
- Compact size
- **3** Innovative weighing with tolerance range: The colour of the display changes depending on the weight (too light/ok/too heavy) and is an aid to help with portioning, dosing and grading

- Thanks to rechargeable battery operation (optional), compact, lightweight construction, it is suitable for the use in several locations
- Recessed grips on the underside of the scale for easy transportation
- Protective working cover included with delivery

Technical data

- Large backlit LCD display, digit height 25 mm
- Dimensions weighing surface, stainless steel, WxD 263x203 mm
- Overall dimensions WxDxH 286x316x126,5 mm
- Net weight approx. 3,2 kg
- Permissible ambient temperature -10 °C/40 °C

Accessories

- Protective working cover, scope of delivery 5 items, KERN RFB-A01S05, **€ 52,-**
- Internal rechargeable battery pack, operating time up to 50 h without backlight, charging time approx. 12 h, KERN WTB-A01N, **€ 38,-**
- **4** Tare pan made from stainless steel, ideal for weighing loose small parts as well as fruits, vegetables, etc., overall dimensions WxDxH 400x300x45 mm, KERN RFS-A02, **€ 75,-**

| | | | | | | | | | |
|----------|--|--|--|--|--|--------|--|---------|--|
| STANDARD | | | | | | OPTION | | FACTORY | |
| | | | | | | | | | |
| | | | | | | | | WTB-NM | |

| Model | Weighing capacity [Max] kg | Readability [d] g | Verification value [e] g | Minimal load [Min] g | Price excl. of VAT ex works € | Options | | | |
|------------|----------------------------------|-------------------------|--------------------------------|----------------------------|--|---------------------------|---|-----------------------------------|-------|
| | | | | | | Verification M KERN | € | DAkKS Calibr. Certificate KERN | € |
| WTB 1K-4N | 1,5 | 0,2 | - | - | 285,- | - | - | 963-127 | 103,- |
| WTB 3K-4N | 3 | 0,5 | - | - | 285,- | - | - | 963-127 | 103,- |
| WTB 6K-3N | 6 | 1 | - | - | 285,- | - | - | 963-128 | 124,- |
| WTB 10K-3N | 15 | 2 | - | - | 285,- | - | - | 963-128 | 124,- |
| WTB 30K-3N | 30 | 5 | - | - | 285,- | - | - | 963-128 | 124,- |

Note: For devices that require verification (conformity assessment according to NAWI 2014/31/EU), please include the verification when placing your order. The initial verification is not possible after delivery. Please inform the full address of the location of use for the initial verification.

| | | | | | | | | | |
|-------------|-----|-----|-----|-----|-------|---------|------|---------|-------|
| WTB 1K-4NM | 1,5 | 0,5 | 0,5 | 10 | 300,- | 965-227 | 65,- | 963-127 | 103,- |
| WTB 3K-3NM | 3 | 1 | 1 | 20 | 300,- | 965-227 | 65,- | 963-127 | 103,- |
| WTB 6K-3NM | 6 | 2 | 2 | 40 | 300,- | 965-228 | 84,- | 963-128 | 124,- |
| WTB 10K-3NM | 15 | 5 | 5 | 100 | 300,- | 965-228 | 84,- | 963-128 | 124,- |
| WTB 30K-2NM | 30 | 10 | 10 | 200 | 300,- | 965-228 | 84,- | 963-128 | 124,- |



7

All-round bench scale, protected by stainless steel and IP65 rating, verification optional

Features

- **1** Ideal for the ever-increasing hygienic requirements in the food, pharmaceutical and chemical industries
- Your support in a HACCP-compliant quality system
- **2** Ideal for the robust industrial applications
- **3** Protection against dust and water splashes IP65 (only when using rechargeable battery pack)
- Thanks to rechargeable battery operation, compact, lightweight construction, it is suitable for the use in several locations (kitchens, sales offices, cafeterias, food industry laboratories, etc.)
- Thanks to the stainless steel design of the housing and platform with smooth surface, the scale is rust-free and easy to clean
- Recessed grips on the underside of the scale for easy transportation

Technical data

- Large backlit LCD display, digit height 25 mm
- Dimensions weighing surface, stainless steel, WxD 233x193 mm
- Overall dimensions WxDxH 243x300x127 mm
- Rechargeable battery pack integrated, as standard, operating time up to 50 h without backlight, charging time approx. 12 h
- Net weight approx. 4,0 kg
- Permissible ambient temperature -10 °C/40 °C

Accessories

- Tare pan made from stainless steel, ideal for weighing loose small parts as well as fruits, vegetables, etc., overall dimensions WxDxH 400x300x45 mm, KERN RFS-A02, **€ 75,-**

STANDARD

CAL EXT UNIT IP 65 ACCU MULTI DMS 1 DAY

3

OPTION FACTORY

DAkkS +3 DAYS M +3 DAYS FFN-M

| Model | Weighing capacity [Max] kg | Readability [d] g | Verification value [e] g | Minimal load [Min] g | Price excl. of VAT ex works € | Options | | | |
|--------------|----------------------------------|-------------------------|--------------------------------|----------------------------|--|---------------------------|---|-----------------------|------------------|
| | | | | | | Verification M KERN | € | DAkkS Calibr. KERN | Certificate € |
| FFN 1K-4N | 1,5 | 0,2 | - | - | 325,- | - | - | 963-127 | 103,- |
| FFN 3K0.5IPN | 3 | 0,5 | - | - | 325,- | - | - | 963-127 | 103,- |
| FFN 6K1IPN | 6 | 1 | - | - | 325,- | - | - | 963-128 | 124,- |
| FFN 15K2IPN | 15 | 2 | - | - | 325,- | - | - | 963-128 | 124,- |
| FFN 25K5IPN | 25 | 5 | - | - | 325,- | - | - | 963-128 | 124,- |

Note: For devices that require verification (conformity assessment according to NAWI 2014/31/EU), please include the verification when placing your order. The initial verification is not possible after delivery. Please inform the full address of the location of use for the initial verification.

| | | | | | | | | | |
|--------------|-----|-----|-----|-----|-------|---------|------|---------|-------|
| FFN 1K-4NM | 1,5 | 0,5 | 0,5 | 10 | 340,- | 965-227 | 65,- | 963-127 | 103,- |
| FFN 3K1IPM | 3 | 1 | 1 | 20 | 340,- | 965-227 | 65,- | 963-127 | 103,- |
| FFN 6K2IPM | 6 | 2 | 2 | 40 | 340,- | 965-228 | 84,- | 963-128 | 124,- |
| FFN 15K5IPM | 15 | 5 | 5 | 100 | 340,- | 965-228 | 84,- | 963-128 | 124,- |
| FFN 25K10IPM | 25 | 10 | 10 | 200 | 340,- | 965-228 | 84,- | 963-128 | 124,- |



Bench scale, protected by stainless steel and protection type IP68, verification optional

Features

- Ideal for the increased hygienic requirements in the food industries
- Your support in a HACCP-compliant quality system
- Ideal for the robust industrial applications
- Thanks to the stainless steel design of the housing and platform with smooth surface, the scale is rust-free and easy to clean
- **1** Dust and splash water protection type IP68. Therefore very robust and durable. Ideal for rough environmental conditions
- Very fast display: steady weight values within 2 s
- Thanks to battery operation, compact, light-weight construction, it is suitable for the use in several locations (kitchens, sales offices, cafeterias, food industry laboratories, etc.)

- **2** Recessed grips on the underside of the scale for easy transportation
- Weighing with tolerance range: a visual and audible signal helps with portioning, dispensing or grading

Technical data

- Large backlit LCD display, digit height 25 mm
- Dimensions weighing surface, stainless steel, WxD 236x195 mm
- Ready for use: Batteries standard, 4x1.5 V Size D, operating time approx. 200 h. AUTO-OFF function to preserve the battery
- Net weight approx. 3,2 kg
- Permissible ambient temperature -10 °C/40 °C

Accessories

- **3** Tare pan made from stainless steel, ideal for weighing loose small parts as well as fruits, vegetables, etc., overall dimensions WxDxH 400x300x45 mm, KERN RFS-A02, **€ 75,-**

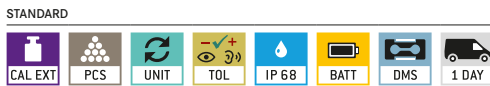

Note: Official verification is mandatory for commercial trade

| Model | Weighing capacity [Max] kg | Readability [d] g | Verification value [e] g | Minimal load [Min] g | Smallest part weight (Normal) g/piece | Price excl. of VAT ex works € | Options | | | |
|-----------------|----------------------------|-------------------|--------------------------|----------------------|---------------------------------------|-------------------------------|-----------------------|---|--------------------|---------------|
| | | | | | | | Verification M KERN € | € | DAkKS Calibr. KERN | Certificate € |
| KERN FXN 3K-4N | 3 | 0,5 | - | - | 5 | 460,- | - | - | 963-127 | 103,- |
| KERN FXN 6K-3N | 6 | 1 | - | - | 10 | 460,- | - | - | 963-128 | 124,- |
| KERN FXN 10K-3N | 15 | 2 | - | - | 20 | 460,- | - | - | 963-128 | 124,- |
| KERN FXN 30K-3N | 30 | 5 | - | - | 50 | 460,- | - | - | 963-128 | 124,- |

Note: For devices that require verification (conformity assessment according to NAWI 2014/31/EU), please include the verification when placing your order. The initial verification is not possible after delivery. Please inform the full address of the location of use for the initial verification.

| | | | | | | | | | | |
|-----------------|----|----|----|-----|----|-------|---------|------|---------|-------|
| KERN FXN 3K-3M | 3 | 1 | 1 | 20 | 5 | 490,- | 965-227 | 65,- | 963-127 | 103,- |
| KERN FXN 6K-3M | 6 | 2 | 2 | 40 | 10 | 490,- | 965-228 | 84,- | 963-128 | 124,- |
| KERN FXN 10K-3M | 15 | 5 | 5 | 100 | 20 | 490,- | 965-228 | 84,- | 963-128 | 124,- |
| KERN FXN 30K-2M | 30 | 10 | 10 | 200 | 50 | 490,- | 965-228 | 84,- | 963-128 | 124,- |

1 ONLY WHILE STOCKS LAST



7



Interlinked for industry of the future: Stainless steel platform scale with up to four data interfaces and optional alibi memory, with optional verification

Features

- Ideal for the robust industrial applications
- Platform: made entirely of stainless steel, hermetically welded stainless steel load cell with protection against dust and water splashes IP68
- Display device: stainless steel, dust and splash water protection IP68, integrated power supply
- Ideal for the increased hygienic requirements in the food industries
- Superior display size: digit height 48 mm, bright backlight for easy reading of weighing results, even in poor lighting conditions
- Standardised, convenient KERN concept of operation, consistency across products in terms of design, menu structure, button functions, interface connection and interface protocol
- The exchange of data and control commands is optional using up to four interfaces to suit individual requirements: two wired connections (RS-232, Ethernet, USB or analogue module) and two wireless connections (WiFi, Bluetooth)

- Each interface can be set up separately, e.g.:
 - Interface 1 (WiFi): Continuous sending to a PC for documentation of a process
 - Interface 2 (RS-232): Print stable weight
 - Interface 3 (analogue module): Controlling a device when the target weight is reached
 - Interface 4 (Bluetooth): Continuous sending to a tablet to monitor a process
- KERN Communication Protocol (KCP): The KCP permits searching and remote control of the balance using external control devices or computers
- Available as an option with alibi memory for paperless archiving of weighing results. This also means the results of weighings with mandatory verification can be electronically evaluated and processed further

Technical data

- Large backlit LCD display, digit height 48 mm
- Weighing platform dimensions W×D×H, stainless steel
 - A** 300×240×107 mm
 - B** 400×300×111 mm
 - C** 400×300×123 mm
 - D** 500×400×120 mm
 - E** 500×400×126 mm
 - F** 650×500×139 mm
- Dimensions of display device W×D×H 232×150×80 mm
- Cable length of display device approx. 3 m
- Permissible ambient temperature -10 °C/40 °C



Accessories

- Internal rechargeable battery pack, operating time up to 48 h without backlight, charging time approx. 8 h, KERN YKR-01, **€ 35,-**
- Stand to be screwed onto the platform
Height of stand approx. 330 mm,
KERN SXC-A01, **€ 95,-**
1 Height of stand approx. 600 mm,
KERN SFB-A01, **€ 110,-**
- Internal data interface RS-232, interface cable included, KERN KUM-01, **€ 120,-**
- Internal data interface USB, interface cable included, KERN KUM-03, **€ 120,-**
- Internal data interface Ethernet, interface cable included, KERN KUM-04, **€ 165,-**
- Internal data interface WiFi,
KERN KUM-05, **€ 95,-**

- Internal data interface Bluetooth,
KERN KUM-06, **€ 135,-**
- Analogue module, KERN KUM-08, **€ 145,-**
- Memory module with real time clock (alibi memory), KERN YMM-06, **€ 160,-**
- ESD drain to protect against electrostatic discharge e.g. for electrostatically-charged weighing objects or people who work with the scale, KERN YGR-01, **€ 60,-**
- Signal lamp for visual support of weighing with tolerance range (only in combination with Data interface RS-232 KERN YKUM-01), KERN CFS-A03, **€ 310,-**
- Roller conveyor attachment, with smooth-running, hot-dip galvanised steel rollers with ball bearings, robust aluminium profile frame for models with weighing plate size

- B, C** KERN YRO-01, **€ 830,-**
- D, E** KERN YRO-02, **€ 870,-**
- F** KERN YRO-03, **€ 1200,-**

• Further details, plenty of further accessories and suitable printers see *Accessories*

STANDARD

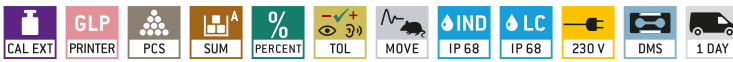

OPTION FACTORY

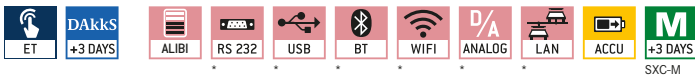

*Note: only two wired connections (RS-232, Ethernet, USB or analogue module) and two wireless connections (WiFi, Bluetooth) can be used at the same time

| Model | Weighing capacity [Max] kg | Readability [d] g | Verification value [e] g | Minimal load [Min] g | Net weight approx. kg | Weighing plate | Price excl. of VAT ex works € | Options | | | |
|---------------|----------------------------|-------------------|--------------------------|----------------------|-----------------------|----------------|-------------------------------|--------------|---|---------------------------|-------|
| | | | | | | | | Verification | € | DAkkS Calibr. Certificate | € |
| KERN SXC 6K-4 | 6 | 0,5 | - | - | 6 | A | 1220,- | - | - | 963-128 | 124,- |
| SXC 10K-3 | 15 | 1 | - | - | 7 | A | 1220,- | - | - | 963-128 | 124,- |
| SXC 10K-3L | 15 | 1 | - | - | 12 | B | 1270,- | - | - | 963-128 | 124,- |
| SXC 30K-3 | 30 | 2 | - | - | 12 | B | 1220,- | - | - | 963-128 | 124,- |
| SXC 30K-3L | 30 | 2 | - | - | 22 | D | 1280,- | - | - | 963-128 | 124,- |
| SXC 60K-3 | 60 | 5 | - | - | 12 | C | 1220,- | - | - | 963-129 | 153,- |
| SXC 60K-3L | 60 | 5 | - | - | 22 | E | 1280,- | - | - | 963-129 | 153,- |
| SXC 100K-2 | 150 | 10 | - | - | 12 | E | 1220,- | - | - | 963-129 | 153,- |
| SXC 100K-2L | 150 | 10 | - | - | 20 | F | 1410,- | - | - | 963-129 | 153,- |
| SXC 300K-2 | 300 | 20 | - | - | 20 | F | 1500,- | - | - | 963-129 | 153,- |

Multi-range balance with high-resolution display, with increasing load it switches automatically to the next largest weighing range [Max] and readout [d] and when the load is fully removed, the balance switches back to the lower range

| | | | | | | | | | | | |
|--------------|-----------|----------|----------|-------------|----|---|--------|---------|-------|---------|-------|
| SXC 6K-3M | 3 6 | 1 2 | 1 2 | 20 40 | 7 | A | 1130,- | 965-228 | 84,- | 963-128 | 124,- |
| SXC 10K-3M | 6 15 | 2 5 | 2 5 | 40 100 | 7 | A | 1130,- | 965-228 | 84,- | 963-128 | 124,- |
| SXC 10K-3LM | 6 15 | 2 5 | 2 5 | 40 100 | 8 | B | 1180,- | 965-228 | 84,- | 963-128 | 124,- |
| SXC 30K-3M | 15 30 | 5 10 | 5 10 | 100 200 | 11 | B | 1130,- | 965-228 | 84,- | 963-128 | 124,- |
| SXC 30K-3LM | 15 30 | 5 10 | 5 10 | 100 200 | 12 | D | 1180,- | 965-228 | 84,- | 963-128 | 124,- |
| SXC 60K-2M | 30 60 | 10 20 | 10 20 | 200 400 | 11 | C | 1130,- | 965-229 | 110,- | 963-129 | 153,- |
| SXC 60K-2LM | 30 60 | 10 20 | 10 20 | 200 400 | 12 | E | 1180,- | 965-229 | 110,- | 963-129 | 153,- |
| SXC 100K-2M | 60 150 | 20 50 | 20 50 | 400 1000 | 12 | E | 1130,- | 965-229 | 110,- | 963-129 | 153,- |
| SXC 100K-2LM | 60 150 | 20 50 | 20 50 | 400 1000 | 20 | F | 1310,- | 965-229 | 110,- | 963-129 | 153,- |
| SXC 300K-2M | 150 300 | 50 100 | 50 100 | 1000 2000 | 20 | F | 1410,- | 965-229 | 110,- | 963-129 | 153,- |

Note: For devices that require verification (conformity assessment according to NAWI 2014/31/EU), please include the verification when placing your order. The initial verification is not possible after delivery. Please inform the full address of the location of use for the initial verification.



Stainless steel platform scales with IP65/67 protection, also with XL platform or optional verification

Features

- Ideal for the robust industrial applications
- Display device: stainless steel, protection against dust and water splashes IP65, (only when using rechargeable battery pack)
- Platform: made entirely of stainless steel, silicone-coated Stainless Steel load cell, protection against dust and water splashes IP67
- **1** KERN SFB-H: Column, standard, for models with weighing plate size
 - A** Height of stand approx. 200 mm
 - B** Height of stand approx. 400 mm

Technical data

- Large backlit LCD display, digit height 52 mm
- Dimensions of display device WxDxH 266x165x96 mm
- Weighing platform dimensions WxDxH, stainless steel
 - A** 300x240x107 mm **B** 400x300x111 mm
 - C** 500x400x120 mm **D** 650x500x139 mm
- Rechargeable battery pack integrated, as standard, operating time up to 35 h without backlight, charging time approx. 12 h
- Permissible ambient temperature -10 °C/40 °C

Accessories

- **2** KERN SFB: Stand, to be screwed onto the platform, height of stand approx. 600 mm, KERN SFB-A01, **€ 110,-**
- Data interface RS-232, interface cable included, approx. 1,5 m, must be ordered at purchase, KERN KFN-A01, **€ 225,-**
- Bluetooth data interface for wireless data transfer to PC or tablets, must be ordered at purchase, not in combination with verification, KERN KFB-A03, **€ 160,-**
- Analogue module, must be ordered at purchase 0-10 V: KERN KFB-A04, **€ 170,-** 4-20 mA: KERN KFB-A05, **€ 170,-**
- Further details, plenty of further accessories and suitable printers see *Accessories*

*Please note: only one optional interface can be fitted for each device

| | | | | | | | | | | | | | | | | | |
|-------------------------------|--|--|--|--|--|--|--|--|--|--------|--|--|---------|--|--|--|--|
| STANDARD | | | | | | | | | | OPTION | | | FACTORY | | | | |
| | | | | | | | | | | | | | | | | | |
| <small>SFB-M / SFB-HM</small> | | | | | | | | | | | | | | | | | |

| Model | Weighing capacity [Max] kg | Readability [d] g | Verification value [e] g | Minimal load [Min] g | Weighing plate | Net weight approx. kg | Price excl. of VAT ex works € | Options | | | | |
|--------------------------------|----------------------------|-------------------|--------------------------|----------------------|----------------|-----------------------|-------------------------------|--------------|------|---------------------------|------------|-------|
| | | | | | | | | Verification | € | DAkKS Calibr. Certificate | € | |
| KERN | | | | | | | | | KERN | | DAkKS KERN | |
| SFB 50K-3XL | 50 | 5 | - | - | C | 14 | 970,- | - | - | - | 963-128 | 124,- |
| SFB 100K-2XL | 100 | 10 | - | - | D | 24 | 1430,- | - | - | - | 963-129 | 153,- |
| 3 With elevated display | | | | | | | | | | | | |
| SFB 10K1HIP | 10 | 1 | - | - | A | 8 | 850,- | - | - | - | 963-128 | 124,- |
| SFB 20K2HIP | 20 | 2 | - | - | A | 8 | 850,- | - | - | - | 963-128 | 124,- |
| SFB 50K5HIP | 50 | 5 | - | - | A | 8 | 850,- | - | - | - | 963-128 | 124,- |
| SFB 50K5LHIP | 50 | 5 | - | - | B | 10 | 820,- | - | - | - | 963-128 | 124,- |
| SFB 100K10HIP | 100 | 10 | - | - | B | 10 | 880,- | - | - | - | 963-129 | 153,- |

Note: For devices that require verification (conformity assessment according to NAWI 2014/31/EU), please include the verification when placing your order. The initial verification is not possible after delivery. Please inform the full address of the location of use for the initial verification.

| | | | | | | | | | | | | |
|--------------------------------|-----|----|----|------|----------|----|---------------|---------|-------|---|---------|-------|
| SFB 60K-2XLM | 60 | 20 | 20 | 400 | C | 14 | 1130,- | 965-229 | 110,- | - | 963-129 | 153,- |
| SFB 100K-2LM | 150 | 50 | 50 | 1000 | C | 14 | 1210,- | 965-229 | 110,- | - | 963-129 | 153,- |
| SFB 100K-2XLM | 150 | 50 | 50 | 1000 | D | 24 | 1450,- | 965-229 | 110,- | - | 963-129 | 153,- |
| 3 With elevated display | | | | | | | | | | | | |
| SFB 15K5HIPM | 15 | 5 | 5 | 100 | A | 8 | 870,- | 965-228 | 84,- | - | 963-128 | 124,- |
| SFB 30K10HIPM | 30 | 10 | 10 | 200 | A | 8 | 870,- | 965-228 | 84,- | - | 963-128 | 124,- |
| SFB 60K20LHIPM | 60 | 20 | 20 | 400 | B | 10 | 890,- | 965-229 | 110,- | - | 963-129 | 153,- |
| SFB 100K-2HM | 150 | 50 | 50 | 1000 | B | 10 | 910,- | 965-229 | 110,- | - | 963-129 | 153,- |

8



PRICE COMPUTING SCALES

Price computing scales are used wherever the price of goods is calculated dependent on the weight of the goods. These scales are subject to obligatory verification (► **Verification**) in accordance with European Directive 2014/31/EU. Usually, these are verification class **M** scales.

KERN mobile retail scales are compact in size and therefore save space on the sales counter. Thanks to the simple menu structure they are easy to use – saving time and money. Fitted with mains or rechargeable batteries as standard, price computing scales can be used in retail shops as well as on mobile sales stalls.

All price computing scales from KERN have three displays showing you all important information at a glance:



- Weight display in kg (verifiable)
- Unit price in €/kg or €/100 g
- Total price in €

NOTE: The KERN RFE range also displays the TARE or PRE-TARE value, which enables this value to be stored in a legally binding way in accordance with the Weights and Measures Act.

All KERN retail scales have direct access keys for memories (► **PLU**), the sales item with the relevant price can be stored against these PLU. In this way, frequently used sales items can be called up at lightning speed. This accelerates customer service and reduces waiting times.

► [See the Glossary](#)

Quick-Finder Price Computing Scales

| Readout | Weighing range | Model | Price excl. of VAT ex works € | Page | M |  |  |  |  |
|----------|----------------|-------------|-------------------------------|------|----------|---|---|---|---|
| [d] g | [Max] kg | KERN | | | | | | | |
| 0,5 1 | 1,5 3 | RPB 3K3DM | 265,- | 79 | ● | ● | ● | ● | ○ |
| 0,5 1 | 1,5 3 | RPB 3K3DHM | 285,- | 79 | ○ | ● | ● | ● | ○ |
| 1 2 | 3 6 | RIB 6K-3M | 255,- | 78 | ○ | ● | ● | ● | ○ |
| 1 2 | 3 6 | RIB 6K-3HM | 305,- | 78 | ○ | ● | ● | ● | ○ |
| 1 2 | 3 6 | RPB 6K1DM | 265,- | 79 | ○ | ● | ● | ● | ○ |
| 1 2 | 3 6 | RPB 6K1DHM | 285,- | 79 | ○ | ● | ● | ● | ○ |
| 2 5 | 6 15 | RIB 10K-3M | 255,- | 78 | ○ | ● | ● | ● | ○ |
| 2 5 | 6 15 | RIB 10K-3HM | 305,- | 78 | ○ | ● | ● | ● | ○ |
| 2 5 | 6 15 | RPB 15K2DM | 265,- | 79 | ○ | ● | ● | ● | ○ |
| 2 5 | 6 15 | RPB 15K2DHM | 285,- | 79 | ○ | ● | ● | ● | ○ |
| 5 10 | 15 30 | RIB 30K-2M | 255,- | 78 | ○ | ● | ● | ● | ○ |
| 5 10 | 15 30 | RIB 30K-2HM | 305,- | 78 | ○ | ● | ● | ● | ○ |
| 5 10 | 15 30 | RPB 30K5DM | 265,- | 79 | ○ | ● | ● | ● | ○ |
| 5 10 | 15 30 | RPB 30K5DHM | 285,- | 79 | ○ | ● | ● | ● | ○ |

For an explanation on the pictos, see the front flap

● Standard ○ Option



8 Robust retail scale with large item memory and user-friendly handling, verification optional

Application examples:

- Retail shops
- Weekly markets
- Farm shops
- Fruit and vegetable sales

Note: Official verification is mandatory for commercial trade

Features

- **1** KERN RIB-HM: Elevated display backlit, height of stand approx. 405 mm
- **2** KERN RIB-M: Second display on the back of the balance
- Three displays for weight display (verifiable), unit price, total price
- 10 direct price keys for frequently recurring article prices
- Memory (PLU) for 20 article prices
- Energy management: Backlight turns off after 5 sec, can be switched off
- Soil-resistant construction through water channels at the frame of the housing and sealing rings over the upper housing inlets
- Protective working cover included with delivery

Technical data

- Large backlit LCD displays, digit height 18 mm
- Dimensions weighing surface, stainless steel, WxD 294x225 mm
- Overall dimensions WxDxH
KERN RIB-M: 325x340x115 mm
KERN RIB-HM: 325x340x405 mm
- Net weight
KERN RIB-M: approx. 3,2 kg
KERN RIB-HM: approx. 3,8 kg
- Permissible ambient temperature -10 °C/40 °C

Accessories

- Protective working cover, scope of delivery 5 items, KERN RIB-A01S05, **€ 52,-**
- Internal rechargeable battery pack, operating time up to 80 h without backlight, charging time approx. 14 h, KERN GAB-A04, **€ 42,-**
- **3** Tare pan made from stainless steel, ideal for weighing loose small parts as well as fruits, vegetables, etc., overall dimensions WxDxH 400x300x45 mm, KERN RFS-A02, **€ 75,-**



| Model | Weighing capacity [Max] kg | Readability [d] g | Verification value [e] g | Minimal load [Min] g | Price excl. of VAT ex works € | Options | | | | |
|---|----------------------------------|-------------------------|--------------------------------|----------------------------|--|---------------------------|------|-----------------------|------------------|--|
| | | | | | | Verification M KERN | € | DAkKS Calibr. KERN | Certificate € | |
| Multi-range balance, with increasing load it switches automatically to the next largest weighing range [Max] and readout [d] and when the load is fully removed, the balance switches back to the lower range | | | | | | | | | | |
| RIB 6K-3M | 3 6 | 1 2 | 1 2 | 20 40 | 255,- | 965-228 | 84,- | 963-128 | 124,- | |
| RIB 10K-3M | 6 15 | 2 5 | 2 5 | 40 100 | 255,- | 965-228 | 84,- | 963-128 | 124,- | |
| RIB 30K-2M | 15 30 | 5 10 | 5 10 | 100 200 | 255,- | 965-228 | 84,- | 963-128 | 124,- | |
| 1 with elevated display | | | | | | | | | | |
| RIB 6K-3HM | 3 6 | 1 2 | 1 2 | 20 40 | 305,- | 965-228 | 84,- | 963-128 | 124,- | |
| RIB 10K-3HM | 6 15 | 2 5 | 2 5 | 40 100 | 305,- | 965-228 | 84,- | 963-128 | 124,- | |
| RIB 30K-2HM | 15 30 | 5 10 | 5 10 | 100 200 | 305,- | 965-228 | 84,- | 963-128 | 124,- | |

Note: For devices that require verification (conformity assessment according to NAWI 2014/31/EU), please include the verification when placing your order. The initial verification is not possible after delivery. Please inform the full address of the location of use for the initial verification.



Retail scale with memories for item prices



Application examples:

- Retail shops
- Weekly markets
- Farm shops
- Fruit and vegetable sales

Note: Official verification is mandatory for commercial trade

Features

- **1** KERN RPB-HM: Elevated display backlit, revolving on column, height of stand approx. 480 mm
- **2** KERN RPB-M: Second display on the back of the balance
- Three displays for weight display (verifiable), unit price, total price
- Memory (PLU) for 10 article prices
- Unit price can be switched from €/kg to €/100 g
- Auto-clear-key: Unit price entry is automatically set to zero when scale is unloaded
- Thanks to rechargeable battery operation (optional), compact, lightweight construction, it is suitable for the use in several locations
- Protective working cover included with delivery

Technical data

- Large backlit LCD displays, digit height 15 mm
- Dimensions weighing surface, stainless steel, WxD 204x263 mm
- Overall dimensions WxDxH
KERN RPB-M: 283x318x110,3 mm
KERN RPB-HM: 283x375,5x486,8 mm
- Net weight
KERN RPB-M: approx. 2,8 kg
KERN RPB-HM: approx. 3,2 kg
- Permissible ambient temperature -10 °C/40 °C

Accessories

- Protective working cover, scope of delivery 5 items, KERN RFC-A02S05, **€ 52,-**
- Internal rechargeable battery pack, operating time up to 60 h without backlight, charging time approx. 12 h, KERN WTB-A01N, **€ 38,-**
- Tare pan made from stainless steel, ideal for weighing loose small parts as well as fruits, vegetables, etc., overall dimensions WxDxH 400x300x45 mm, KERN RFS-A02, **€ 75,-**
- Further details, plenty of further accessories and suitable printers see *Accessories*

| STANDARD | OPTION | FACTORY |
|--|-----------------|--------------|
| CAL EXT MEMORY RS 232 UNIT MULTI DMS 1 DAY | ACCU +3 DAYS | M +3 DAYS |

| Model | Weighing capacity [Max] kg | Readability [d] g | Verification value [e] g | Minimal load [Min] g | Price excl. of VAT ex works € | Options | | | | |
|---|----------------------------------|-------------------------|--------------------------------|----------------------------|--|---------------------------|------|---------------|------------------|--|
| | | | | | | Verification M KERN | € | DAkkS KERN | Certificate € | |
| Multi-division balance, with increasing or decreasing load, it switches automatically to the next largest or smallest weighing range [Max] and readout [d]. | | | | | | | | | | |
| RPB 3K3DM | 1,5 3 | 0,5 1 | 0,5 1 | 10 | 265,- | 965-227 | 65,- | 963-127 | 103,- | |
| RPB 6K1DM | 3 6 | 1 2 | 1 2 | 20 | 265,- | 965-228 | 84,- | 963-128 | 124,- | |
| RPB 15K2DM | 6 15 | 2 5 | 2 5 | 40 | 265,- | 965-228 | 84,- | 963-128 | 124,- | |
| RPB 30K5DM | 15 30 | 5 10 | 5 10 | 100 | 265,- | 965-228 | 84,- | 963-128 | 124,- | |
| 1 with elevated display | | | | | | | | | | |
| RPB 3K3DHM | 1,5 3 | 0,5 1 | 0,5 1 | 10 | 285,- | 965-227 | 65,- | 963-127 | 103,- | |
| RPB 6K1DHM | 3 6 | 1 2 | 1 2 | 20 | 285,- | 965-228 | 84,- | 963-128 | 124,- | |
| RPB 15K2DHM | 6 15 | 2 5 | 2 5 | 40 | 285,- | 965-228 | 84,- | 963-128 | 124,- | |
| RPB 30K5DHM | 15 30 | 5 10 | 5 10 | 100 | 285,- | 965-228 | 84,- | 963-128 | 124,- | |

Note: For devices that require verification (conformity assessment according to NAWI 2014/31/EU), please include the verification when placing your order. The initial verification is not possible after delivery. Please inform the full address of the location of use for the initial verification.

9



COUNTING SCALES, COUNTING SYSTEMS

Interesting Facts about Counting

Smallest part weight for piece counting

This is the smallest piece weight the scale will accept for piece counting and will display it piece by piece. In practice, depending on the required accuracy, we recommend to choose a counting scale with a minimum piece weight smaller than the weight of the item to be counted. To make it easier for you to select the right model, we specify the smallest part weight when counting under laboratory conditions and normal conditions, see the website.

► Counting resolution

Describes the maximum quantity which can be counted with a counting accuracy of 1 %, with a minimum variation of item weights and a sufficiently large ► **reference quantity** (20 pieces with counting resolution ≤ 60,000 points, 50 pieces from 60,000–150,000 points, 100 pieces ≥ 150,000 points). This therefore is an indication of the quality of the counting scale.

Recommended ► reference quantity

Weight tolerances of pieces to be counted are the most significant sources of error when counting. Therefore, at the start of every counting procedure, establish an average weight, the so-called ► **reference weight**, by placing several pieces on the balance, the so-called reference quantity. Usually this would be:

- 5 pieces >> often sufficient
- 10 pieces >> common practise
- 20–100 pieces >> for large deviations among piece weights

The “automatic ► **reference optimisation**” function increases the reference quantity gradually, whereby the average piece weight is optimised step by step. This contributes considerably to the accuracy of the subsequent counting processes.

Which Counting Scale for Which Application?

Simple counting scale

With self-explanatory user guidance on the keyboard. The graphic control panel enables you to start working immediately, without having to consult the user manual. Easy handling, value for money.

Professional counting scale

With 3 separate displays for reference weight (average weight of the pieces), total weight of all pieces and total quantity of all pieces. Very useful integrated memories, e.g. for container weight, item number, reference weight as well as audible and visual counting aids and an alphanumeric key pad for easy data entry.

Special tip for counting large quantities: Counting systems

The weighing capacities of bench counting scales are often not sufficient to count large quantities, units, palletized items, etc. In this case, high-performing counting systems come into operation, as these combine a high-precision reference scale with a high-capacity bulk scale.









► See the Glossary

Quick-Finder Counting Scales/Counting Systems

| Readability | Weighing capacity | Smallest part weight | Counting resolution | Model | Price excl. of VAT | Page |  | | | | | |
|-------------|-------------------|----------------------|---------------------|---------------|--------------------|------|---|---|---|---|---|---|
| [d] g | [Max] kg | (Normal) g/piece | Points | KERN | ex works € | | For an explanation on the pictos, see the front flap | | | | | |
| 0,001 | 0,3 | 0,05 | 60.000 | CFS 300-3 | 510,- | 86 | ● | ● | ● | ● | ● | ○ |
| 0,001 | 0,36 | 0,02 | 180.000 | CKE 360-3 | 395,- | 87 | ● | ● | ○ | ○ | ● | ○ |
| 0,001 | 6 | 0,05 | 1.200.000 | CCS 6K-6 | 660,- | 92 | ● | ● | ● | ● | ○ | ○ |
| 0,001 | 15 | 0,05 | 3.000.000 | CCS 10K-6 | 740,- | 92 | ● | ● | ● | ● | ○ | ○ |
| 0,01 | 3 6 | 0,2 | 300.000 | CCA 6K-5M | 1040,- | 90 | ○ | ● | ● | ● | ● | ○ |
| 0,01 | 3 | 0,5 | 60.000 | CFS 3K-5 | 395,- | 86 | ● | ● | ● | ● | ● | ○ |
| 0,01 | 3,6 | 0,2 | 180.000 | CKE 3600-2 | 425,- | 87 | ● | ● | ○ | ○ | ● | ○ |
| 0,01 | 6 15 | 0,2 | 750.000 | CCA 10K-5M | 1040,- | 90 | ○ | ● | ● | ● | ● | ○ |
| 0,01 | 15 30 | 0,2 | 1.500.000 | CCA 30K-5M | 1140,- | 90 | ○ | ● | ● | ● | ● | ○ |
| 0,01 | 30 60 | 0,2 | 3.000.000 | CCA 60K-5M | 1150,- | 90 | ○ | ● | ● | ● | ● | ○ |
| 0,01 | 30 | 0,5 | 600.000 | CCS 30K0.01. | 730,- | 92 | ● | ● | ● | ● | ○ | ○ |
| 0,01 | 60 150 | 0,2 | 7.500.000 | CCA 100K-5M | 1300,- | 90 | ○ | ● | ● | ● | ● | ○ |
| 0,01 | 60 | 0,5 | 1.200.000 | CCS 60K0.01. | 720,- | 92 | ● | ● | ● | ● | ○ | ○ |
| 0,01 | 60 | 0,5 | 1.200.000 | CCS 60K0.01L. | 770,- | 92 | ● | ● | ● | ● | ○ | ○ |
| 0,01 | 150 | 0,5 | 3.000.000 | CCS 150K0.01L | 1080,- | 92 | ● | ● | ● | ● | ○ | ○ |
| 0,01 | 150 | 0,5 | 3.000.000 | CCS 150K0.01 | 850,- | 92 | ● | ● | ● | ● | ○ | ○ |
| 0,01 | 300 | 0,5 | 6.000.000 | CCS 300K0.01 | 1170,- | 92 | ● | ● | ● | ● | ○ | ○ |
| 0,02 | 4 | 0,2 | 200.000 | CDS 4K0.02 | 690,- | 89 | ● | ● | ○ | ○ | ○ | ○ |
| 0,02 | 6 | 0,2 | 300.000 | CKE 6K0.02 | 550,- | 87 | ● | ● | ○ | ○ | ● | ○ |
| 0,05 | 8 | 0,5 | 160.000 | CKE 8K0.05 | 520,- | 87 | ● | ● | ○ | ○ | ● | ○ |
| 0,05 | 15 | 0,5 | 300.000 | CDS 15K0.05 | 640,- | 89 | ● | ● | ○ | ○ | ○ | ○ |
| 0,05 | 16 | 0,5 | 320.000 | CKE 16K0.05 | 610,- | 87 | ● | ● | ○ | ○ | ● | ○ |
| 0,1 0,2 | 3 6 | 1 | 60.000 | IFS 6K-4S | 500,- | 88 | ● | ● | ● | ● | ○ | ○ |
| 0,1 0,2 | 6 15 | 2 | 75.000 | IFS 10K-4 | 550,- | 88 | ● | ● | ● | ● | ○ | ○ |
| 0,1 | 3 6 | 1 | 60.000 | CCA 6K-4M | 1000,- | 90 | ○ | ● | ● | ● | ● | ○ |
| 0,1 | 6 15 | 1 | 150.000 | CCA 10K-4M | 1000,- | 90 | ○ | ● | ● | ● | ● | ○ |
| 0,1 | 6 | 1 | 60.000 | CPB 6K0.1N | 290,- | 85 | ● | ● | ● | ● | ○ | ○ |
| 0,1 | 6 | 1 | 60.000 | CFS 6K0.1 | 340,- | 86 | ● | ● | ● | ● | ● | ○ |
| 0,1 | 15 30 | 1 | 300.000 | CCA 30K-4M | 1100,- | 90 | ○ | ● | ● | ● | ● | ○ |
| 0,1 | 16 | 1 | 160.000 | CKE 16K0.1 | 530,- | 87 | ● | ● | ○ | ○ | ● | ○ |
| 0,1 | 16 | 1 | 160.000 | CDS 16K0.1 | 630,- | 89 | ● | ● | ○ | ○ | ○ | ○ |
| 0,1 | 30 60 | 1 | 600.000 | CCA 60K-4M | 1100,- | 90 | ○ | ● | ● | ● | ● | ○ |
| 0,1 | 30 | 1 | 300.000 | CDS 30K0.1L | 1150,- | 89 | ● | ● | ○ | ○ | ○ | ○ |
| 0,1 | 30 | 1 | 300.000 | CCS 30K0.1. | 670,- | 92 | ● | ● | ● | ● | ○ | ○ |
| 0,1 | 30 | 1 | 300.000 | CDS 30K0.1 | 670,- | 89 | ● | ● | ○ | ○ | ○ | ○ |
| 0,1 | 36 | 1 | 360.000 | CKE 36K0.1 | 570,- | 87 | ● | ● | ○ | ○ | ● | ○ |
| 0,1 | 60 150 | 1 | 1.500.000 | CCA 100K-4M | 1250,- | 90 | ○ | ● | ● | ● | ● | ○ |
| 0,1 | 60 | 1 | 600.000 | CCS 60K0.1. | 730,- | 92 | ● | ● | ● | ● | ○ | ○ |
| 0,1 | 60 | 1 | 600.000 | CCS 60K0.1L. | 820,- | 92 | ● | ● | ● | ● | ○ | ○ |
| 0,1 | 150 | 1 | 1.500.000 | CCS 150K0.1L | 1095,- | 92 | ● | ● | ● | ● | ○ | ○ |
| 0,1 | 150 | 1 | 1.500.000 | CCS 150K0.1. | 760,- | 92 | ● | ● | ● | ● | ○ | ○ |
| 0,1 | 300 | 1 | 3.000.000 | CCS 300K0.1 | 1110,- | 92 | ● | ● | ● | ● | ○ | ○ |
| 0,1 | 600 | 1 | 6.000.000 | CCS 600K-1S | 1840,- | 92 | ● | ● | ● | ● | ○ | ○ |
| 0,1 | 1500 | 1 | 15.000.000 | CCS 1T-4S | 1740,- | 92 | ● | ● | ● | ● | ○ | ○ |
| 0,1 | 1500 | 1 | 15.000.000 | CCS 1T-1U | 1790,- | 92 | ● | ● | ● | ● | ○ | ○ |
| 0,1 | 1500 | 1 | 15.000.000 | CCS 1T-4 | 2200,- | 92 | ● | ● | ● | ● | ○ | ○ |
| 0,1 | 1500 | 1 | 15.000.000 | CCS 1T-1L | 2750,- | 92 | ● | ● | ● | ● | ○ | ○ |
| 0,1 | 3000 | 1 | 30.000.000 | CCS 3T-3L | 2540,- | 92 | ● | ● | ● | ● | ○ | ○ |
| 0,2 0,5 | 12 30 | 5 | 60.000 | IFS 30K0.2DL | 610,- | 88 | ● | ● | ● | ● | ○ | ○ |
| 0,2 | 3 | 1 | 30.000 | CIB 3K-4 | 265,- | 83 | ● | ● | ● | ● | ● | ○ |
| 0,2 | 3 | 1 | 30.000 | CXB 3K0.2 | 350,- | 84 | ● | ● | ● | ● | ● | ○ |
| 0,2 | 15 | 2 | 75.000 | CFS 15K0.2 | 340,- | 86 | ● | ● | ● | ● | ● | ○ |
| 0,2 | 15 | 2,5 | 60.000 | CPB 15K0.2N | 290,- | 85 | ● | ● | ● | ● | ○ | ○ |
| 0,2 | 36 | 2 | 180.000 | CDS 36K0.2L | 1150,- | 89 | ● | ● | ○ | ○ | ○ | ○ |
| 0,2 | 60 | 2 | 300.000 | CDS 60K0.2 | 1150,- | 89 | ● | ● | ○ | ○ | ○ | ○ |
| 0,2 | 65 | 2 | 325.000 | CKE 65K0.2 | 560,- | 87 | ● | ● | ○ | ○ | ● | ○ |
| 0,5 1 | 30 60 | 10 | 60.000 | IFS 60K0.5D | 610,- | 88 | ● | ● | ● | ● | ○ | ○ |
| 0,5 1 | 30 60 | 10 | 60.000 | IFS 60K0.5DL | 780,- | 88 | ● | ● | ● | ● | ○ | ○ |
| 0,5 | 6 | 2 | 30.000 | CIB 6K-4 | 265,- | 83 | ● | ● | ● | ● | ● | ○ |
| 0,5 | 6 | 2 | 30.000 | CXB 6K0.5 | 350,- | 84 | ● | ● | ● | ● | ● | ○ |
| 0,5 | 30 | 5 | 60.000 | CPB 30K0.5N | 290,- | 85 | ● | ● | ● | ● | ○ | ○ |
| 0,5 | 30 | 5 | 60.000 | CFS 30K0.5 | 340,- | 86 | ● | ● | ● | ● | ● | ○ |
| 1 2 | 3 | 1 | 60.000 | CPB 6K1DM | 290,- | 85 | ○ | ● | ● | ● | ● | ○ |
| 1 2 | 3 | 1 | 60.000 | IFS 6K-3M | 475,- | 88 | ○ | ● | ● | ● | ● | ○ |
| 1 2 | 3 | 1 | 60.000 | IFS 6K-3SM | 480,- | 88 | ○ | ● | ● | ● | ● | ○ |
| 1 2 | 75 150 | 25 | 60.000 | IFS 100K-3L | 1100,- | 88 | ● | ● | ● | ● | ○ | ○ |
| 1 2 | 75 150 | 25 | 60.000 | IFS 100K-3 | 860,- | 88 | ● | ● | ● | ● | ○ | ○ |
| 1 | 3 | 1 | 30.000 | CXB 3K1NM | 380,- | 84 | ○ | ● | ● | ● | ● | ○ |
| 1 | 15 | 5 | 30.000 | CIB 10K-3 | 265,- | 83 | ● | ● | ● | ● | ● | ○ |
| 1 | 15 | 5 | 30.000 | CXB 15K1 | 355,- | 84 | ● | ● | ● | ● | ● | ○ |
| 1 | 50 | 10 | 50.000 | CFS 50K-3 | 395,- | 86 | ● | ● | ● | ● | ○ | ○ |

● Standard ○ Option

Quick-Finder Counting Scales/Counting Systems

| Readability [d] g | Weighing capacity [Max] kg | Smallest part weight (Normal) g/piece | Counting resolution Points | Model KERN | Price excl. of VAT ex works € | Page |  |  |  |  |  |  |  |  |
|-------------------------|----------------------------------|---|-------------------------------|----------------------|--|------|---|---|---|---|---|---|---|---|
| 2 5 | 6 15 | 2 | 75.000 | IFS 10K-3M | 475,- | 88 | <input type="radio"/> | <input checked="" type="radio"/> | <input checked="" type="radio"/> | <input checked="" type="radio"/> | <input checked="" type="radio"/> | <input checked="" type="radio"/> | <input checked="" type="radio"/> | <input checked="" type="radio"/> |
| 2 5 | 6 15 | 2 | 75.000 | IFS 10K-3LM | 560,- | 88 | <input type="radio"/> | <input checked="" type="radio"/> | <input checked="" type="radio"/> | <input checked="" type="radio"/> | <input checked="" type="radio"/> | <input checked="" type="radio"/> | <input checked="" type="radio"/> | <input checked="" type="radio"/> |
| 2 5 | 6 15 | 2,5 | 60.000 | CPB 15K2DM | 290,- | 85 | <input type="radio"/> | <input checked="" type="radio"/> | <input checked="" type="radio"/> | <input checked="" type="radio"/> | <input checked="" type="radio"/> | <input checked="" type="radio"/> | <input checked="" type="radio"/> | <input checked="" type="radio"/> |
| 2 5 | 150 300 | 50 | 60.000 | IFS 300K-3 | 1 100,- | 88 | <input type="radio"/> | <input checked="" type="radio"/> | <input checked="" type="radio"/> | <input checked="" type="radio"/> | <input checked="" type="radio"/> | <input checked="" type="radio"/> | <input checked="" type="radio"/> | <input checked="" type="radio"/> |
| 2 | 6 | 2 | 30.000 | CXB 6K2NM | 380,- | 84 | <input type="radio"/> | <input checked="" type="radio"/> | <input checked="" type="radio"/> | <input checked="" type="radio"/> | <input checked="" type="radio"/> | <input checked="" type="radio"/> | <input checked="" type="radio"/> | <input checked="" type="radio"/> |
| 2 | 30 | 10 | 30.000 | CIB 30K-3 | 265,- | 83 | <input type="radio"/> | <input checked="" type="radio"/> | <input checked="" type="radio"/> | <input checked="" type="radio"/> | <input checked="" type="radio"/> | <input checked="" type="radio"/> | <input checked="" type="radio"/> | <input checked="" type="radio"/> |
| 2 | 30 | 10 | 30.000 | CXB 30K2 | 350,- | 84 | <input type="radio"/> | <input checked="" type="radio"/> | <input checked="" type="radio"/> | <input checked="" type="radio"/> | <input checked="" type="radio"/> | <input checked="" type="radio"/> | <input checked="" type="radio"/> | <input checked="" type="radio"/> |
| 5 10 | 15 30 | 5 | 60.000 | CPB 30K5DM | 290,- | 85 | <input type="radio"/> | <input checked="" type="radio"/> | <input checked="" type="radio"/> | <input checked="" type="radio"/> | <input checked="" type="radio"/> | <input checked="" type="radio"/> | <input checked="" type="radio"/> | <input checked="" type="radio"/> |
| 5 10 | 15 30 | 5 | 60.000 | IFS 30K-3M | 560,- | 88 | <input type="radio"/> | <input checked="" type="radio"/> | <input checked="" type="radio"/> | <input checked="" type="radio"/> | <input checked="" type="radio"/> | <input checked="" type="radio"/> | <input checked="" type="radio"/> | <input checked="" type="radio"/> |
| 5 | 15 | 5 | 30.000 | CXB 15K5NM | 380,- | 84 | <input type="radio"/> | <input checked="" type="radio"/> | <input checked="" type="radio"/> | <input checked="" type="radio"/> | <input checked="" type="radio"/> | <input checked="" type="radio"/> | <input checked="" type="radio"/> | <input checked="" type="radio"/> |
| 10 20 | 30 60 | 10 | 60.000 | IFS 60K-2M | 570,- | 88 | <input type="radio"/> | <input checked="" type="radio"/> | <input checked="" type="radio"/> | <input checked="" type="radio"/> | <input checked="" type="radio"/> | <input checked="" type="radio"/> | <input checked="" type="radio"/> | <input checked="" type="radio"/> |
| 10 20 | 30 60 | 10 | 60.000 | IFS 60K-2LM | 710,- | 88 | <input type="radio"/> | <input checked="" type="radio"/> | <input checked="" type="radio"/> | <input checked="" type="radio"/> | <input checked="" type="radio"/> | <input checked="" type="radio"/> | <input checked="" type="radio"/> | <input checked="" type="radio"/> |
| 10 | 30 | 10 | 30.000 | CXB 30K10NM | 380,- | 84 | <input type="radio"/> | <input checked="" type="radio"/> | <input checked="" type="radio"/> | <input checked="" type="radio"/> | <input checked="" type="radio"/> | <input checked="" type="radio"/> | <input checked="" type="radio"/> | <input checked="" type="radio"/> |
| 20 50 | 60 150 | 25 | 60.000 | IFS 100K-2M | 710,- | 88 | <input type="radio"/> | <input checked="" type="radio"/> | <input checked="" type="radio"/> | <input checked="" type="radio"/> | <input checked="" type="radio"/> | <input checked="" type="radio"/> | <input checked="" type="radio"/> | <input checked="" type="radio"/> |
| 20 50 | 60 150 | 25 | 60.000 | IFS 100K-2LM | 960,- | 88 | <input type="radio"/> | <input checked="" type="radio"/> | <input checked="" type="radio"/> | <input checked="" type="radio"/> | <input checked="" type="radio"/> | <input checked="" type="radio"/> | <input checked="" type="radio"/> | <input checked="" type="radio"/> |

For an explanation on the pictos, see the front flap

● Standard ○ Option



Robust counting scale with large article memory, convenient operating philosophy and checkweighing display, counting resolution up to 30,000 points

Features

- Innovative counting with tolerance range (Checkweighing): The counting process can be supported visually and/or audibly and this therefore makes portion division, dispensing and grading easier
 - visual signal: the colour of the display changes depending on the counting result (not enough/ok/too much)
 - audible signal: the frequency of the audible signal changes depending on the counting result (not enough/ok/too much)
- Ideal for workshops for people with disabilities, particularly loud or quiet environments, where operators change frequently, etc.
- Three displays for weight display, reference weight, total pieces
- The automatic reference weight optimisation of reference weight gradually improves the average piece weight value
- Programmable using numerical key pad:
 - required reference quantity
 - known reference weight

- Counting results memory: adds up all individual piece counts, result is shown in total weight and total pieces
- PRE-TARE function for manual subtraction of a known container weight, useful for checking fill-levels
- 20 direct price keys for frequently recurring reference weights and PRE-Tare values
- Memory for 50 reference weights and PRE-Tare values
- Thanks to rechargeable battery operation, compact, lightweight construction, it is suitable for the use in several locations
- Changes from counting mode to weighing mode at the touch of a key
- Energy management: Backlight turns off after 5 sec, can be switched off
- Protective working cover included with delivery

Technical data

- Large backlit LCD displays, digit height 18 mm
- Dimensions weighing surface, stainless steel, WxD 315x215 mm
- Overall dimensions WxDxH 350x330x120 mm
- Rechargeable battery pack integrated, as standard, operating time up to 160 h without backlight, charging time approx. 14 h
- Net weight approx. 4,0 kg
- Permissible ambient temperature -10 °C/40 °C

Accessories

- Protective working cover, scope of delivery 5 items, KERN RIB-A01S05, **€ 52,-**
- Internal rechargeable battery pack, operating time up to 160 h without backlight, charging time approx. 14 h, KERN GAB-A04, **€ 42,-**

STANDARD

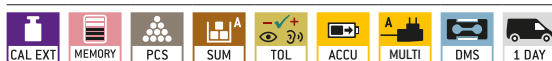

OPTION



| Model | Weighing capacity [Max] kg | Readability [d] g | Smallest part weight (Normal) g/piece | Counting resolution Points | Price excl. of VAT ex works € | Options | |
|------------------|----------------------------------|-------------------------|---|-------------------------------|--|--|-------|
| | | | | | | DAkKS Calibr. Certificate DAkKS KERN | € |
| CIB 3K-4 | 3 | 0,2 | 1 | 30.000 | 265,- | 963-127 | 103,- |
| CIB 6K-4 | 6 | 0,5 | 2 | 30.000 | 265,- | 963-128 | 124,- |
| CIB 10K-3 | 15 | 1 | 5 | 30.000 | 265,- | 963-128 | 124,- |
| CIB 30K-3 | 30 | 2 | 10 | 30.000 | 265,- | 963-128 | 124,- |



Entry level model into professional counting, counting resolution of 30,000 points, verification optional

9

Features

- The automatic reference weight optimisation of reference weight gradually improves the average piece weight value
- Programmable using numerical key pad:
 - required reference quantity
 - known reference weight
- Three displays for weight display (verifiable), reference weight, total pieces
- Fill-to-target function: Target count or target weight can be programmed. When the target weight is reached there is an audible and visual signal
- 10 memories for reference weights
- Counting results memory: adds up all individual piece counts, result is shown in total weight and total pieces
- Integrated ESD protection, which makes it ideal for weighing small plastic parts

- Energy management: Backlight turns off after 5 sec
- PRE-TARE function for manual subtraction of a known container weight, useful for checking fill-levels
- Changes from counting mode to weighing mode at the touch of a key
- Protective working cover included with delivery

Technical data

- Large backlit LCD displays, digit height 18 mm
- Dimensions weighing surface, stainless steel, WxD 300x225 mm
- Overall dimensions WxDxH 300x330x110 mm
- Rechargeable battery pack integrated, as standard, operating time up to 200 h without backlight, charging time approx. 8 h
- Net weight approx. 4,0 kg
- Permissible ambient temperature -10 °C/40 °C

Accessories

- Protective working cover, scope of delivery 5 items, KERN CXB-A01S05, € 52,-
- Internal rechargeable battery pack, operating time up to 200 h without backlight, charging time approx. 8 h, KERN GAB-A04, € 42,-

Note: Official verification is mandatory for commercial trade

STANDARD



OPTION



FACTORY



| Model | Weighing capacity [Max] kg | Readability [d] g | Verification value [e] g | Minimal load [Min] g | Smallest part weight (Normal) g/piece | Counting resolution Points | Price excl. of VAT ex works € | Options | | | |
|------------------|----------------------------|-------------------|--------------------------|----------------------|---------------------------------------|----------------------------|-------------------------------|---------------------|---|--------------------|---------------|
| | | | | | | | | Verification M KERN | € | DAkkS Calibr. KERN | Certificate € |
| CXB 3K0.2 | 3 | 0,2 | - | - | 1 | 30.000 | 350,- | - | - | 963-127 | 103,- |
| CXB 6K0.5 | 6 | 0,5 | - | - | 2 | 30.000 | 350,- | - | - | 963-128 | 124,- |
| CXB 15K1 | 15 | 1 | - | - | 5 | 30.000 | 355,- | - | - | 963-128 | 124,- |
| CXB 30K2 | 30 | 2 | - | - | 10 | 30.000 | 350,- | - | - | 963-128 | 124,- |

Note: For devices that require verification (conformity assessment according to NAWI 2014/31/EU), please include the verification when placing your order. The initial verification is not possible after delivery. Please inform the full address of the location of use for the initial verification.

| | | | | | | | | | | | |
|--------------------|----|----|----|-----|----|--------|--------------|---------|------|---------|-------|
| CXB 3K1NM | 3 | 1 | 1 | 20 | 1 | 30.000 | 380,- | 965-227 | 65,- | 963-127 | 103,- |
| CXB 6K2NM | 6 | 2 | 2 | 40 | 2 | 30.000 | 380,- | 965-228 | 84,- | 963-128 | 124,- |
| CXB 15K5NM | 15 | 5 | 5 | 100 | 5 | 30.000 | 380,- | 965-228 | 84,- | 963-128 | 124,- |
| CXB 30K10NM | 30 | 10 | 10 | 200 | 10 | 30.000 | 380,- | 965-228 | 84,- | 963-128 | 124,- |



Professional model, counting resolution 60,000 points, verification optional

Features

- The automatic reference weight optimisation of reference weight gradually improves the average piece weight value
- Programmable using numerical key pad:
 - required reference quantity
 - known reference weight
- Three displays for weight display (verifiable), reference weight, total pieces
- Counting results memory: adds up all individual piece counts, result is shown in total weight and total pieces
- Fill-to-target function: Target count or target weight can be programmed. When the target value is reached, this will be indicated by an audible signal
- PRE-TARE function for manual subtraction of a known container weight, useful for checking fill-levels

- Thanks to rechargeable battery operation (optional), compact, lightweight construction, it is suitable for the use in several locations
- Changes from counting mode to weighing mode at the touch of a key
- Protective working cover included with delivery

Technical data

- Large backlit LCD displays, digit height 20 mm
- Dimensions weighing surface, stainless steel, WxD 295x225 mm
- Overall dimensions WxDxH 315x350x100 mm
- Net weight approx. 3,2 kg
- Permissible ambient temperature 0 °C/40 °C

Accessories

- Protective working cover, scope of delivery 5 items, KERN CFS-A02S05, € 52,-
- Internal rechargeable battery pack, operating time up to 90 h without backlight, charging time approx. 12 h, KERN GAB-A04, € 42,-
- **■** Signal lamp for visual support of weighing with tolerance range, KERN CFS-A03, € 310,-
- Y-cable for parallel connection of two terminal devices to the RS-232 interface on the scale, e.g. signal lamp and printer, KERN CFS-A04, € 38,-
- Further details, plenty of further accessories and suitable printers see *Accessories*

Note: Official verification is mandatory for commercial trade

| | | | | | | | | | | | | |
|----------|--------|--------|-----|-----|-----|-----|-------|-----|-------|--------|-------|---------|
| STANDARD | | | | | | | | | | OPTION | | FACTORY |
| | | | | | | | | | | | | |
| CAL EXT | MEMORY | RS 232 | KCP | PCS | SUM | TOL | MULTI | DMS | 1 DAY | ACCU | DAkkS | +3 DAYS |
| | | | | | | | | | | | | CPB-DM |

| Model | Weighing capacity [Max] | Readability [d] | Verification value [e] | Minimal load [Min] | Smallest part weight (Normal) g/piece | Counting resolution Points | Price excl. of VAT ex works € | Options | | | |
|---|-------------------------|-----------------|------------------------|--------------------|---------------------------------------|----------------------------|-------------------------------|--------------|-------|---------|-------------|
| | | | | | | | | Verification | DAkkS | Calibr. | Certificate |
| KERN | kg | g | g | g | g/piece | Points | € | KERN | € | KERN | € |
| CPB 6K0.1N | 6 | 0,1 | - | - | 1 | 60.000 | 290,- | - | - | 963-128 | 124,- |
| CPB 15K0.2N | 15 | 0,2 | - | - | 2,5 | 60.000 | 290,- | - | - | 963-128 | 124,- |
| CPB 30K0.5N | 30 | 0,5 | - | - | 5 | 60.000 | 290,- | - | - | 963-128 | 124,- |
| Multi-division balance, with increasing or decreasing load, it switches automatically to the next largest or smallest weighing range [Max] and readout [d]. | | | | | | | | | | | |
| CPB 6K1DM | 3 6 | 1 2 | 1 2 | 20 | 1 | 60.000 | 290,- | 965-228 | 84,- | 963-128 | 124,- |
| CPB 15K2DM | 6 15 | 2 5 | 2 5 | 40 | 2,5 | 60.000 | 290,- | 965-228 | 84,- | 963-128 | 124,- |
| CPB 30K5DM | 15 30 | 5 10 | 5 10 | 100 | 5 | 60.000 | 290,- | 965-228 | 84,- | 963-128 | 124,- |

Note: For devices that require verification (conformity assessment according to NAWI 2014/31/EU), please include the verification when placing your order. The initial verification is not possible after delivery. Please inform the full address of the location of use for the initial verification.



Professional, high-resolution counting scale with 100 item memories and second balance interface, counting resolution up to 75,000 points

9

Features

- Memory (PLU) for 100 items with additional text, reference weight and tare weight, e.g. of a container
- The automatic reference weight optimisation of reference weight gradually improves the average piece weight value
- Programmable using numerical key pad:
 - required reference quantity
 - known reference weight
- Three displays for weight display, reference weight, total pieces
- Weighing with tolerance range: a visual and audible signal helps with portioning, dispensing or grading
- Fill-to-target function: Programmable target quantity or target weight e.g. for checkweighing. A signal will be displayed when the target value is reached
- PRE-TARE function for manual subtraction of a known container weight, useful for checking fill-levels

- Second balance interface to construct a high-resolution counting system, standard, e.g. with weighing bridges of KERN KFP V20
- Draught shield standard for models with weighing plate size **A**, weighing space W×D×H 155×141×80 mm
- Protective working cover included with delivery, for models with weighing plate size **A**, **B**

Technical data

- Large backlit LCD displays, digit height 20 mm
- Dimensions weighing surface
 - A** ø 80 mm
 - B** W×D 295×225 mm, see larger picture
 - C** W×D 370×240 mm
- Overall dimensions W×D×H
 - A** 315×350×110 mm/315×350×185 mm (incl. draught shield)
 - B** 315×350×100 mm
 - C** 370×360×100 mm
- Permissible ambient temperature 0 °C/40 °C

Accessories

- **A**, **B**: Protective working cover, scope of delivery 5 items, KERN CFS-A02S05, € 52,-
- Internal rechargeable battery pack, operating time up to 70 h without backlight, charging time approx. 14 h, KERN GAB-A04, € 42,-
- Signal lamp for visual support of weighing with tolerance range, KERN CFS-A03, € 310,-
- Y-cable for parallel connection of two terminal devices to the RS-232 interface on the scale, e.g. signal lamp and printer, KERN CFS-A04, € 38,-
- Further details, plenty of further accessories and suitable printers see *Accessories*

STANDARD



OPTION



| Model | Weighing capacity [Max] kg | Readability [d] g | Smallest part weight (Normal) g/piece | Counting resolution Points | Net weight approx. kg | Weighing plate | Price excl. of VAT ex works € | Options | |
|----------------|----------------------------|-------------------|---------------------------------------|----------------------------|-----------------------|----------------|-------------------------------|---------|---------------------|
| | | | | | | | | DAkKS | Calibr. Certificate |
| KERN CFS 300-3 | 0,3 | 0,001 | 0,05 | 60.000 | 2,6 | A | 510,- | 963-127 | 103,- |
| CFS 3K-5 | 3 | 0,01 | 0,5 | 60.000 | 3,4 | B | 395,- | 963-127 | 103,- |
| CFS 6K0.1 | 6 | 0,1 | 1 | 60.000 | 3,2 | B | 340,- | 963-128 | 124,- |
| CFS 15K0.2 | 15 | 0,2 | 2 | 75.000 | 3,4 | B | 340,- | 963-128 | 124,- |
| CFS 30K0.5 | 30 | 0,5 | 5 | 60.000 | 3,4 | B | 340,- | 963-128 | 124,- |
| CFS 50K-3 | 50 | 1 | 10 | 50.000 | 4,4 | C | 395,- | 963-128 | 124,- |



Easy to use, self-explanatory counting scale with laboratory accuracy, ideal for the various possibilities of Industry 4.0 applications, counting resolution up to 360.000 points

Features

- Self-explanatory, graphic control panel
 - no learning time = reduces costs
 - ideal for untrained users
 - visualised process avoids operating errors
- The 4 steps are carried out from left to right:
 - Place the empty container onto the weighing plate and tare by pressing the TARE key
 - Place the reference quantity for the goods to be counted into the container (5, 10, 20 or any number of pieces)
 - Confirm the selected reference quantity by pressing the key (5, 10, 20 or any number of pieces)
 - Pour in the goods to be counted. The number of pieces will immediately be shown in the display

- The automatic reference weight optimisation of reference weight gradually improves the average piece weight value
- KERN Universal Port (KUP): permits the connection of an external KUP interface adapter, such as, for example, RS-232, USB, Bluetooth, WiFi or Ethernet, for the exchange of data and control commands, without any installation outlay
- KERN Communication Protocol (KCP): The KCP permits searching and remote control of the balance using external control devices or computers
- Changes from counting mode to weighing mode at the touch of a key
- Ring-shaped draught shield standard, only for models with weighing plate size **A**, weighing space $\varnothing \times H$ 90×40 mm
- Protective working cover included with delivery

Technical data

- Large backlit LCD display, digit height 25 mm
- Optional battery operation, 4×1.5 V AA not included in scope of delivery, operating time up to 20 h
- Dimensions weighing surface
 - A** \varnothing 82 mm, plastic
 - B** W×D 130×130 mm, plastic, see larger picture
 - C** W×D 340×240 mm, stainless steel
- Overall dimensions W×D×H
 - A** 163×245×65 mm/163×245×123 mm (incl. draught shield)
 - B** 163×245×65 mm
 - C** 350×390×120 mm
- Permissible ambient temperature -10 °C/40 °C

Accessories

- A**, **B** Protective working cover, scope of delivery 5 items, KERN YBA-A12S05, € 52,-
- C** Protective working cover, scope of delivery 5 items, KERN FKB-A02S05, € 52,-
- Internal rechargeable battery pack, operating time up to 48 h without backlight, charging time approx. 8 h, KERN YKR-01, € 35,-
- External data interface RS-232, interface cable included, KERN KUP-01, € 60,-
- External data interface USB, interface cable included, KERN KUP-03, € 75,-
- WiFi interface adapter, KERN KUP-05, € 75,-
- Extension box for connecting up to three interfaces in parallel, KERN KUP-13, € 75,-
- Further details, plenty of further accessories and suitable printers see *Accessories*

STANDARD

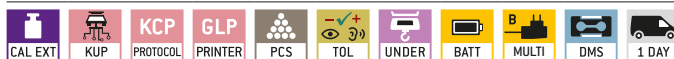

OPTION

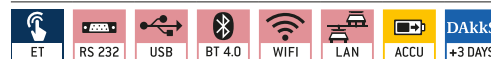

| Model | Weighing capacity [Max] kg | Readability [d] g | Smallest part weight (Normal) g/piece | Counting resolution Points | Net weight approx. kg | Weighing plate | Price excl. of VAT ex works € | Options | |
|--------------------|----------------------------|-------------------|---------------------------------------|----------------------------|-----------------------|----------------|-------------------------------|---------|---------------------|
| | | | | | | | | DAkKS | Calibr. Certificate |
| KERN | | | | | | | | DAkKS | € |
| CKE 360-3 | 0,36 | 0,001 | 0,02 | 180.000 | 0,85 | A | 395,- | 963-127 | 103,- |
| CKE 3600-2 | 3,6 | 0,01 | 0,2 | 180.000 | 1,6 | B | 425,- | 963-127 | 103,- |
| CKE 6K0.02 | 6 | 0,02 | 0,2 | 300.000 | 7 | C | 550,- | 963-128 | 124,- |
| CKE 8K0.05 | 8 | 0,05 | 0,5 | 160.000 | 7 | C | 520,- | 963-128 | 124,- |
| CKE 16K0.05 | 16 | 0,05 | 0,5 | 320.000 | 7 | C | 610,- | 963-128 | 124,- |
| CKE 16K0.1 | 16 | 0,1 | 1 | 160.000 | 7 | C | 530,- | 963-128 | 124,- |
| CKE 36K0.1 | 36 | 0,1 | 1 | 360.000 | 7 | C | 570,- | 963-128 | 124,- |
| CKE 65K0.2 | 65 | 0,2 | 2 | 325.000 | 7 | C | 560,- | 963-129 | 153,- |



Industrial counting scale with convenient decimal keypad and high counting resolution, verification optional

Features

- Display device with large keypad and high-contrast LCD display for easy entry and reading of, e.g., tare weights, reference weights, limit values etc.
- Three displays for weight display (verifiable), reference weight, total pieces
- 100 item memories for master data such as reference weight, reference quantity, container weight (PRE-TARE) etc.
- The manual reference weight optimisation gradually improves the average value of the piece weight

- Totalising of pieces when counting
- Printout with date and time
- Protective working cover over the display device included with the delivery

Technical data

- Large backlit LCD displays, digit height 16,5 mm
- Weighing platform dimensions W×D×H, stainless steel
 - A** 230×230×110 mm **B** 300×240×110 mm
 - C** 400×300×120 mm **D** 500×400×120 mm
 - E** 650×500×140 mm



- Dimensions of display device W×D×H 260×150×65 mm
- Cable length of display device approx. 3 m
- Permissible ambient temperature -10 °C/40 °C

Accessories

- Protective working cover over the display device, scope of delivery 5 items, KERN KFB-A02S05, € 52,-
- Stand to elevate display device
 - 1 A - E** Height of stand approx. 330 mm, KERN IFB-A01, € 68,-
 - D, E** Height of stand approx. 600 mm, KERN IFB-A02, € 81,-
- Internal rechargeable battery pack, operating time up to 18 h without backlight, charging time approx. 12 h, must be ordered at purchase, KERN KFB-A01, € 40,-
- **2** ESD drain to protect against electrostatic discharge e.g. for electrostatically-charged weighing objects or people who work with the scale, KERN YGR-01, € 60,-
- Further details, plenty of further accessories and suitable printers see *Accessories*

STANDARD: CAL EXT, MEMORY, RS 232, KCP, GLP, INTERN, PCS, SUM, TOL, MULTI, DMS, 1 DAY

OPTION: DAKKS, +3 DAYS

FACTORY: ACCU, +3 DAYS, M IFS-M

| Model | Weighing capacity [Max] kg | Readability [d] g | Verification value [e] g | Minimal load [Min] g | Smallest part weight (Normal) g/piece | Net weight approx. kg | Weighing plate | Price excl. of VAT ex works € | Options | | | | | |
|---|----------------------------|-------------------|--------------------------|----------------------|---------------------------------------|-----------------------|----------------|-------------------------------|-------------------------|---|--------------------------------|-------|--|--|
| | | | | | | | | | Verification M IFS KERN | € | DAkKS Calibr. Certificate KERN | € | | |
| Multi-division balance, with increasing or decreasing load, it switches automatically to the next largest or smallest weighing range [Max] and readout [d]. (Remaining stock contains multi-range scales) | | | | | | | | | | | | | | |
| IFS 6K-4S | 3 6 | 0,1 0,2 | - | - | 1 | 3,8 | A | 500,- | - | - | 963-128 | 124,- | | |
| IFS 10K-4 | 6 15 | 0,1 0,2 | - | - | 2 | 6 | B | 550,- | - | - | 963-128 | 124,- | | |
| IFS 30K0.2DL | 12 30 | 0,2 0,5 | - | - | 5 | 7 | C | 610,- | - | - | 963-128 | 124,- | | |
| IFS 60K0.5D | 30 60 | 0,5 1 | - | - | 10 | 7 | C | 610,- | - | - | 963-129 | 153,- | | |
| IFS 60K0.5DL | 30 60 | 0,5 1 | - | - | 10 | 12 | D | 780,- | - | - | 963-129 | 153,- | | |
| IFS 100K-3 | 75 150 | 1 2 | - | - | 25 | 12 | D | 860,- | - | - | 963-129 | 153,- | | |
| IFS 100K-3L | 75 150 | 1 2 | - | - | 25 | 20 | E | 1100,- | - | - | 963-129 | 153,- | | |
| IFS 300K-3 | 150 300 | 2 5 | - | - | 50 | 22 | E | 1100,- | - | - | 963-129 | 153,- | | |

Note: For devices that require verification (conformity assessment according to NAWI 2014/31/EU), please include the verification when placing your order. The initial verification is not possible after delivery. Please inform the full address of the location of use for the initial verification.

| | | | | | | | | | | | | |
|--------------|----------|---------|---------|------------|----|-----|----------|-------|---------|-------|---------|-------|
| IFS 6K-3SM | 3 6 | 1 2 | 1 2 | 20 40 | 1 | 3,8 | A | 480,- | 965-228 | 84,- | 963-128 | 124,- |
| IFS 6K-3M | 3 6 | 1 2 | 1 2 | 20 40 | 1 | 5,0 | B | 475,- | 965-228 | 84,- | 963-128 | 124,- |
| IFS 10K-3M | 6 15 | 2 5 | 2 5 | 40 100 | 2 | 4,8 | B | 475,- | 965-228 | 84,- | 963-128 | 124,- |
| IFS 10K-3LM | 6 15 | 2 5 | 2 5 | 40 100 | 2 | 7 | C | 560,- | 965-228 | 84,- | 963-128 | 124,- |
| IFS 30K-3M | 15 30 | 5 10 | 5 10 | 100 200 | 5 | 7 | C | 560,- | 965-228 | 84,- | 963-128 | 124,- |
| IFS 60K-2M | 30 60 | 10 20 | 10 20 | 200 400 | 10 | 7 | C | 570,- | 965-229 | 110,- | 963-129 | 153,- |
| IFS 60K-2LM | 30 60 | 10 20 | 10 20 | 200 400 | 10 | 13 | D | 710,- | 965-229 | 110,- | 963-129 | 153,- |
| IFS 100K-2M | 60 150 | 20 50 | 20 50 | 400 1000 | 25 | 12 | D | 710,- | 965-229 | 110,- | 963-129 | 153,- |
| IFS 100K-2LM | 60 150 | 20 50 | 20 50 | 400 1000 | 25 | 22 | E | 960,- | 965-229 | 110,- | 963-129 | 153,- |



Easy to use industrial counting scale for heavy loads, counting resolution up to 300,000 points, ideal for the diverse possibilities of Industry 4.0 applications

Features

- Self-explanatory, graphic control panel
 - no learning time = reduces costs
 - ideal for untrained users
 - visualised process avoids operating errors
- The 4 steps are carried out from left to right:
 - Place the empty container onto the weighing plate and tare by pressing the TARE key
 - Place the reference quantity for the goods to be counted into the container (5, 10 or 20 pieces)
 - Confirm the selected reference quantity by pressing the key (5, 10 or 20)
 - Pour in the goods to be counted. The number of pieces will immediately be shown in the display
- The automatic reference weight optimisation of reference weight gradually improves the average piece weight value
- KERN Universal Port (KUP): permits the connection of an external KUP interface adapter,

- such as, for example, RS-232, USB, Bluetooth, WiFi or Ethernet, for the exchange of data and control commands, without any installation outlay
- KERN Communication Protocol (KCP): The KCP permits searching and remote control of the balance using external control devices or computers
- Standardised, simplified concept of operation
- Protective working cover over the display device included with the delivery

Technical data

- Backlit LCD display, digit height 21 mm
- Weighing platform dimensions, stainless steel
 - A** W×D×H 230×230×103 mm
 - B** W×D×H 308×318×75 mm, see larger picture
 - C** W×D×H 500×400×125 mm
- Dimensions of display device W×D×H 225×115×60 mm
- Permissible ambient temperature -10 °C/40 °C



Accessories

- Protective working cover over the display device, scope of delivery 5 items, KERN DE-A12S05, € 44,-
- Internal rechargeable battery pack, operating time up to 48 h without backlight, charging time approx. 8 h, KERN YKR-01, € 35,-
- Suitable for models with weighing plate size
 - B**: Mount to fasten the display device to the platform, KERN DE-A11N, € 40,-
 - 5** Stand to elevate display device
 - B**: Height of stand approx. 480 mm, KERN DE-A10, € 128,-
 - C**: Height of stand approx. 600 mm, KERN DS-A03, € 140,-
 - 6** Set for underfloor weighing, consists of platform, bow, hook, only for models with weighing plate **B**, KERN DS-A01, € 230,-
- External data interface RS-232, interface cable included, KERN KUP-01, € 60,-
- External data interface USB, interface cable included, KERN KUP-03, € 75,-
- Ethernet interface adapter, KERN KUP-04, € 115,-
- WiFi interface adapter, KERN KUP-05, € 75,-
- Bluetooth interface adapter, KERN KUP-06, € 99,-
- Extension box for connecting up to three interfaces in parallel, KERN KUP-13, € 75,-
- Further details, plenty of further accessories and suitable printers see *Accessories*

STANDARD



OPTION



| Model | Weighing capacity [Max] kg | Readability [d] g | Smallest part weight (Normal) g/piece | Counting resolution Points | Net weight approx. kg | Cable length approx. m | Weighing plate | Price excl. of VAT ex works € | Options | |
|-----------------|----------------------------|-------------------|---------------------------------------|----------------------------|-----------------------|------------------------|----------------|-------------------------------|---------|---------------------|
| | | | | | | | | | DAkKS | Calibr. Certificate |
| KERN CDS 4K0.02 | 4 | 0,02 | 0,2 | 200.000 | 8 | 2,5 | A | 690,- | 963-127 | 103,- |
| CDS 15K0.05 | 15 | 0,05 | 0,5 | 300.000 | 8 | 2,5 | B | 640,- | 963-128 | 124,- |
| CDS 16K0.1 | 16 | 0,1 | 1 | 160.000 | 8 | 2,5 | B | 630,- | 963-128 | 124,- |
| CDS 30K0.1 | 30 | 0,1 | 1 | 300.000 | 8 | 2,5 | B | 670,- | 963-128 | 124,- |
| CDS 30K0.1L | 30 | 0,1 | 1 | 300.000 | 19 | 2,5 | C | 1150,- | 963-128 | 124,- |
| CDS 36K0.2L | 36 | 0,2 | 2 | 180.000 | 19 | 2,5 | C | 1150,- | 963-128 | 124,- |
| CDS 60K0.2 | 60 | 0,2 | 2 | 300.000 | 19 | 2,5 | C | 1150,- | 963-129 | 153,- |

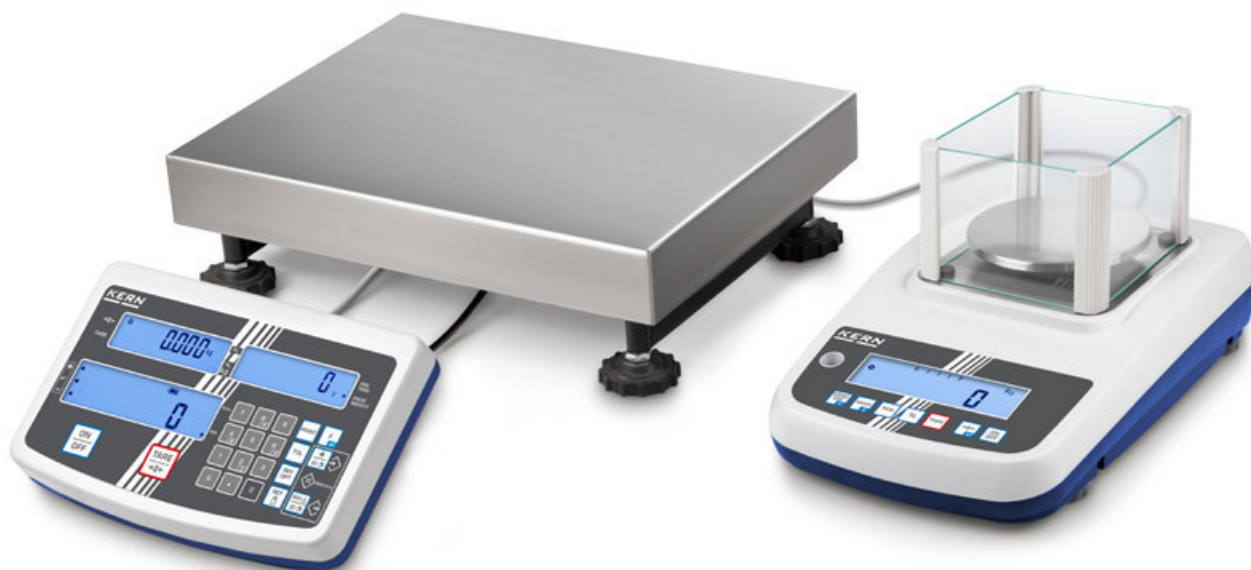

9

High-resolution counting system to count the smallest parts in large quantities, maximum number of parts which can be displayed is 999,999, verification optional

Features

- The highly accurate KERN CCA counting system can replace a whole range of individual balances, efficiently and at a reasonable price
- Thanks to optional verification, it is also suitable for use in verified applications
- The balances are connected to one another with an RS-232 Y-cable, which also allows you to connect a printer

Reference scale KERN EWJ

- This precision balance, which can be used as an individual balance, also fulfils the highest demands through connection with a high-capacity platform
- Automatic internal adjustment, time-controlled every 2 h, guarantees high degree of accuracy and makes the balance independent of its location
- Draught shield standard for models with [Max] = 600 g, weighing space W×D×H 134×128×80 mm
- Protective working cover included with delivery

Quantity scale KERN IFS

- The high-accuracy quantity counting takes place on the weighing platform IFS. In this way even the smallest of parts can be counted in large volumes
- Tough industry standard suitable for use in harsh industrial applications
- Display device with large keypad and high-contrast LCD display for easy entry and reading of, e.g., tare weights, reference weights, limit values etc.
- Three displays for weight display, reference weight, total pieces
- 100 item memories for master data such as reference weight, reference quantity, container weight (PRE-TARE) etc.
- The manual reference weight optimisation gradually improves the average value of the piece weight
- Totalising of pieces when counting
- Printout with date and time
- Aluminium singlepoint load cell (1×3000 e), protection against dust and water splashes IP65
- Protective working cover over the display device included with the delivery



Technical data

Reference scale KERN EWJ

- Dimensions weighing surface, stainless steel [Max] 600 g: \varnothing 120 mm
- **1** [Max] 6000 g: WxD 155x145 mm
- Overall dimensions WxDxH [Max] 600 g: 220x340x180 mm (incl. draught shield)
- [Max] 6000 g: 220x340x105 mm
- Net weight [Max] 600 g: approx. 3,2 kg
- [Max] 6000 g: approx. 3,4 kg

Quantity scale KERN IFS

- Weighing platform dimensions, stainless steel
- **A** WxDxH 300x240x105 mm
- **B** WxDxH 400x300x114 mm
- **C** WxDxH 500x400x140 mm
- Cable length of display device approx. 3 m

Counting System KERN CCA

- Connection cable approx. 1,5 m
- Net weight
- **A** approx. 9 kg
- **B** approx. 14 kg
- **C** approx. 16 kg

Accessories

Reference scale KERN EWJ

- Protective working cover, scope of delivery 5 items, KERN EWJ-A04S05, **€ 52,-**
- Internal rechargeable battery pack, operating time up to 57 h without backlight, charging time approx. 6,5 h, KERN KFB-A01, **€ 40,-**

Quantity scale KERN IFS

- Protective working cover over the display device, scope of delivery 5 items, KERN KFB-A02S05, **€ 52,-**
- Internal rechargeable battery pack, operating time up to 18 h without backlight, charging time approx. 12 h, KERN KFB-A01, **€ 40,-**
- **2** Stand to elevate display device Height of stand approx. 330 mm, KERN IFB-A01, **€ 68,-**
- For models with weighing plate size **A**, **B**: Height of stand approx. 600 mm, KERN IFB-A02, **€ 81,-**
- **3** ESD drain to protect against electrostatic discharge e.g. for electrostatically-charged weighing objects or people who work with the scale, KERN YGR-01, **€ 60,-**
- Further details, plenty of further accessories and suitable printers see Accessories

Note: Official verification is mandatory for commercial trade

STANDARD

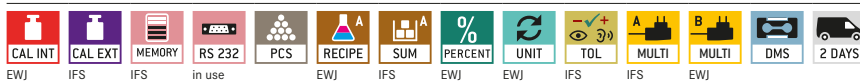

OPTION



FACTORY

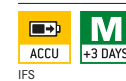

| Model | Quantity scale | | Weighing plate | Reference scale | | Smallest part weight (Normal) g/piece | Price excl. of VAT ex works € | Options | | | |
|-------------|-------------------------|-------------------|----------------|------------------------|-------------------|---------------------------------------|-------------------------------|--------------|------------|---------------------|-------|
| | Weighing range [Max] kg | Readability [d] g | | Weighing range [Max] g | Readability [d] g | | | Verification | DAkkS | Calibr. Certificate | |
| KERN | | | | | | | € | € | DAkkS KERN | € | |
| CCA 6K-5M | 3 6 | 1 2 | A | 600 | 0,01 | 0,2 | 1040,- | 965-228-216 | 145,- | 962-128-127 | 225,- |
| CCA 6K-4M | 3 6 | 1 2 | A | 6000 | 0,1 | 1 | 1000,- | 965-229-216 | 190,- | 962-129-127 | 245,- |
| CCA 10K-5M | 6 15 | 2 5 | A | 600 | 0,01 | 0,2 | 1040,- | 965-228-216 | 145,- | 962-128-127 | 225,- |
| CCA 10K-4M | 6 15 | 2 5 | A | 6000 | 0,1 | 1 | 1000,- | 965-229-216 | 190,- | 962-129-127 | 245,- |
| CCA 30K-5M | 15 30 | 5 10 | B | 600 | 0,01 | 0,2 | 1140,- | 965-228-216 | 145,- | 962-128-127 | 225,- |
| CCA 30K-4M | 15 30 | 5 10 | B | 6000 | 0,1 | 1 | 1100,- | 965-229-216 | 190,- | 962-129-127 | 245,- |
| CCA 60K-5M | 30 60 | 10 20 | B | 600 | 0,01 | 0,2 | 1150,- | 965-229-216 | 190,- | 962-129-127 | 245,- |
| CCA 60K-4M | 30 60 | 10 20 | B | 6000 | 0,1 | 1 | 1100,- | 965-229-216 | 190,- | 962-129-127 | 245,- |
| CCA 100K-5M | 60 150 | 20 50 | C | 600 | 0,01 | 0,2 | 1300,- | 965-229-216 | 190,- | 962-129-127 | 245,- |
| CCA 100K-4M | 60 150 | 20 50 | C | 6000 | 0,1 | 1 | 1250,- | 965-229-216 | 190,- | 962-129-127 | 245,- |

Note: For devices that require verification (conformity assessment according to NAWI 2014/31/EU), please include the verification when placing your order. The initial verification is not possible after delivery. Please inform the full address of the location of use for the initial verification.



9

Counting system to count the smallest parts in large quantities, maximum number of parts which can be displayed is 999,999

Features

- The highly accurate KERN CCS counting system can replace a whole range of individual balances, efficiently and at a reasonable price

Reference scale KERN CFS

- This professional counting scale, which can also be used as a stand-alone scale, meets the highest demands for accuracy, weighing capacity and volume of items, by being connected to a high-capacity weighing bridge
- Programmable using numerical key pad:
 - required reference quantity
 - known reference weight
- Three displays for weight display, reference weight, total pieces
- Memory (PLU) for 100 items with additional text, reference weight and tare weight, e.g. of a container
- Fill-to-target function: Target count or target weight can be programmed. When the target weight is reached there is an audible and visual signal

- The automatic reference weight optimisation of reference weight gradually improves the average piece weight value
- Draught shield standard for models with [d] = 0,001 g, weighing space W×D×H 155×141×80 mm
- Protective working cover included with delivery

Quantity scale

KERN KFP/KERN KFU/KERN KIP

- The high-accuracy quantity counting takes place on the weighing platform (= weighing bridge). In this way even the smallest of parts can be counted in large volumes

Platform KERN KFP-V20 IP65

- Weighing plate stainless steel, painted steel base
- Aluminium singlepoint load cell, protection against dust and water splashes IP65
- Models with weighing plate size **A - E**

Weighing bridge KERN KIP-V20M IP67

- Lacquered steel weighing bridge, corrugated steel plate. Extremely resistant to bending due to material thickness
- 4 load cells, alloy steel, silicone-coated, IP67
- Models with weighing plate size **F, G, H**

Weighing bridge KERN KFP-V20 IP67

- Weighing bridge painted steel, weighing plate screwed on from the top
- 4 load cells, alloy steel, silicone-coated, IP67
- Models with weighing plate size **I**

U-shaped weighing bridge KERN KFU-V20

- Load range: painted steel
- 4 load cells, alloy steel, silicone-coated, IP67
- Models with weighing plate size **J**



Technical data

Reference scale KERN CFS

- Dimensions weighing surface, stainless steel
 - 1** [d] = 0,001 g: \varnothing 80 mm
 - [d] \geq 0,01 g: WxD 295x225 mm
- Overall dimensions WxDxH 315x350x100 mm
- Net weight
 - 1** [d] = 0,001 g: approx. 2,6 kg
 - [d] \geq 0,01 g: approx. 3,4 kg

Quantity platforms, KERN KFP-V20 IP67

- Weighing platform dimensions, stainless steel
 - A** WxDxH 230x230x103 mm
 - B** WxDxH 300x240x105 mm
 - C** WxDxH 400x300x114 mm
 - D** WxDxH 500x400x124 mm
 - E** WxDxH 650x500x136 mm

Quantity platforms, KERN KIP-V20M

- Weighing platform dimensions, coated metal
 - F** WxDxH 1000x1000x108 mm
 - G** WxDxH 1200x1500x108 mm
 - H** WxDxH 1500x1500x108 mm

Bulk weighing bridges, KERN KFP-V20 IP67

- Weighing platform dimensions, coated metal
 - 1** WxDxH 1500x1250x80 mm

Bulk pallet load handling, KERN KFU-V20

- Weighing platform dimensions, coated metal
 - J** WxDxH 840x1190x90 mm
- Connection cable approx.
 - A - E** 3 m
 - F - J** 5 m

Accessories

- Protective working cover, scope of delivery 5 items, KERN CFS-A02S05, **€ 52,-**
- 2** Suitable for models with weighing plate size **A - E**: ESD drain to protect against electrostatic discharge e.g. for electrostatically-charged weighing objects or people who work with the scale, KERN YGR-01, **€ 60,-**
- Internal rechargeable battery pack, operating time up to 70 h without backlight, charging time approx. 14 h, KERN GAB-A04, **€ 42,-**
- Signal lamp for visual support of weighing with tolerance range, KERN CFS-A03, **€ 310,-**
- Y-cable for parallel connection of two terminal devices to the RS-232 interface on the scale, e.g. signal lamp and printer, KERN CFS-A04, **€ 38,-**
- Further details, plenty of further accessories and suitable printers see *Accessories*

STANDARD

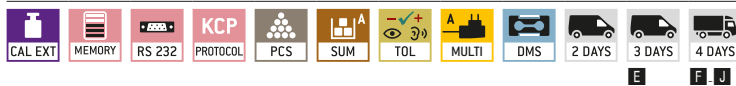

OPTION



| Model | Quantity scale | | Weighing plate | Reference scale | | Counting resolution | Smallest part weight (Normal) g/piece | Price excl. of VAT ex works € | Options | |
|---------------|-------------------------|-------------------|----------------|------------------------|-------------------|---------------------|---------------------------------------|-------------------------------|-------------|---------------------|
| | Weighing range [Max] kg | Readability [d] g | | Weighing range [Max] g | Readability [d] g | | | | DAKKS | Calibr. Certificate |
| KERN | | | | | | Points | | DAKKS KERN | € | |
| CCS 6K-6 | 6 | 0,2 | A | 300 | 0,001 | 1.200.000 | 0,05 | 660,- | 962-128-127 | 225,- |
| CCS 10K-6 | 15 | 0,5 | B | 300 | 0,001 | 3.000.000 | 0,05 | 740,- | 962-128-127 | 225,- |
| CCS 30K0.01. | 30 | 1 | C | 3000 | 0,01 | 600.000 | 0,5 | 730,- | 962-128-127 | 225,- |
| CCS 30K0.1. | 30 | 1 | C | 6000 | 0,1 | 300.000 | 1 | 670,- | 962-128-128 | 240,- |
| CCS 60K0.01. | 60 | 2 | C | 3000 | 0,01 | 1.200.000 | 0,5 | 720,- | 962-129-127 | 245,- |
| CCS 60K0.01L. | 60 | 2 | D | 3000 | 0,01 | 1.200.000 | 0,5 | 770,- | 962-129-127 | 245,- |
| CCS 60K0.1. | 60 | 2 | C | 6000 | 0,1 | 600.000 | 1 | 730,- | 962-129-128 | 275,- |
| CCS 60K0.1L. | 60 | 2 | D | 6000 | 0,1 | 600.000 | 1 | 820,- | 962-129-128 | 275,- |
| CCS 150K0.01 | 150 | 5 | D | 3000 | 0,01 | 3.000.000 | 0,5 | 850,- | 962-129-127 | 245,- |
| CCS 150K0.01L | 150 | 5 | E | 3000 | 0,01 | 3.000.000 | 0,5 | 1080,- | 962-129-127 | 245,- |
| CCS 150K0.1. | 150 | 5 | D | 6000 | 0,1 | 1.500.000 | 1 | 760,- | 962-129-128 | 275,- |
| CCS 150K0.1L | 150 | 5 | E | 6000 | 0,1 | 1.500.000 | 1 | 1095,- | 962-129-128 | 275,- |
| CCS 300K0.1* | 300 | 10 | E | 6000 | 0,1 | 3.000.000 | 1 | 1110,- | 962-129-128 | 275,- |
| CCS 300K0.01* | 300 | 10 | E | 3000 | 0,01 | 6.000.000 | 0,5 | 1170,- | 962-129-127 | 245,- |
| CCS 600K-1S* | 600 | 200 | F | 6000 | 0,1 | 6.000.000 | 1 | 1840,- | 962-130-127 | 320,- |
| CCS 1T-4S* | 1500 | 500 | F | 6000 | 0,1 | 15.000.000 | 1 | 1740,- | 962-130-128 | 335,- |
| CCS 1T-4* | 1500 | 500 | G | 6000 | 0,1 | 15.000.000 | 1 | 2200,- | 962-130-128 | 335,- |
| CCS 1T-1L* | 1500 | 500 | H | 6000 | 0,1 | 15.000.000 | 1 | 2750,- | 962-130-128 | 335,- |
| CCS 1T-1U* | 1500 | 500 | J | 6000 | 0,1 | 15.000.000 | 1 | 1790,- | 962-130-128 | 335,- |
| CCS 3T-3L* | 3000 | 1000 | I | 6000 | 0,1 | 30.000.000 | 1 | 2540,- | 962-132-128 | 680,- |

I * ONLY WHILE STOCKS LAST



VERSATILE PRODUCTS

You will always find the right model for your application in our wide range of platform scales.

The unbeatable benefits of platform scales:

- Weighing range from 3 kg - 600 kg
- Robust platform construction for the harshest industrial use
- Versatile, available with column
- High degree of overload protection
- Stainless steel weighing plate, shock proof and easy to clean
- Large selection of platform sizes
- Display device can be positioned separately, e.g. wall-mounted, on a column or next to the platform. Clear view for the user of the display even with bulky items on the scale.

→ Top Tip:

If you can't find what you are looking for in our standard range, then we can offer you our CUSOS service: Perfect weighing solutions with personalised platform sizes, specific software solutions and adapted peripheral devices.

For further information on this, see page 142/143.

KERN platform scales – as versatile as your areas of use

- Entry-level models – portable, economical and well-made – e.g. for weighing post and packages
- High-quality models – with high IP rating and with EC type approval for commercial trade
- Top models – as a user-friendly solution for a wide range of recipe weighing or check-weighing applications with relay control and much more

Tip: With KERN EasyTouch you can expand the range of possible applications for efficient balances even further.

True allrounders – suitable for entry-level users and industrial professionals

In order to fulfil the diverse requirements of our industrial customers, KERN platform scales have a large number of practical features, such as, for example, counting and totalising functions, data interfaces (RS 232, RS 485, USB, Bluetooth, WLAN, Ethernet, analogue module), options for integration into networks, PC or printer connections, rechargeable battery/battery operation for mobile use and much more. KERN platform scales – just true allrounders!

Note: The “Hold function” is particularly useful for industrial weighing and guarantees stable weights even when the ambient conditions is unstable.

The very best in user-friendliness

With KERN EasyTouch on the display device (PC, laptop, tablet, smartphone), the display can be connected wirelessly via Bluetooth or WiFi. This means it is possible to weigh directly at the location of use and read the results from a distance of up to 20 metres.



You can find a large selection of platform scales and practical accessories, such as, for example, columns etc. in *Accessories* or on the internet.

10



PARCEL SCALES, PLATFORM SCALES

Whether in the warehouse, production or dispatch, our parcel and platform scales offer the perfect solution for precise and reliable weighing. With a robust design and straightforward handling, they make light work of all weighing tasks, from small parcels to heavy loads. Benefit from the sturdy construction and long-lasting reliability of our products.

Discover our selection now and find the perfect balance for your requirements!



Digital weighing data – with KERN EasyTouch

Discover KERN EasyTouch - innovative software, which combines the precision of our tried and tested KERN balances with the versatility of Windows or Android environments.

This is how KERN EasyTouch works:

1. Collection of weighing and measuring data using an appropriate measuring device
2. Transfer, saving and processing in relation to master data such as item data, order data, batch data and user data
3. Output or transfer of data to connected systems or peripheral devices

Tip: Turn your balance into a powerful weighing system!

Using the KERN EasyTouch App even a simple single balance can be made into a powerful weighing system, which offers a range of functions. To do this you simply have to install the KERN EasyTouch App on your PC or tablet (Windows® or Android™), connect the balance (either with cable or wireless), activate the App and you will be able to control your balance using your PC or tablet straightaway (see page 136).



Quick-Finder Parcel Scales/Platform Scales

| Readability | Weighing capacity | Weighing plate | Model | Price excl. of VAT | Page |  | | | | | | | | | | | | | | |
|-------------|-------------------|----------------|-------------|--------------------|------|--|---|---|---|---|--|--|--|--|--|--|--|--|--|---|
| [d] | [Max] | WxDxH | KERN | € | | For an explanation on the pictos, see the front flap | | | | | | | | | | | | | | |
| g | kg | mm | | | | | | | | | | | | | | | | | | |
| 0,01 | 3 | 230x230x103 | DS 3K0.01S | 710,- | 111 | ● | ● | ○ | ● | ● | | | | | | | | | | ○ |
| 0,05 | 5 | 230x230x103 | DS 5K0.05S | 640,- | 111 | ● | ● | ○ | ● | ● | | | | | | | | | | ○ |
| 0,05 | 8 | 308x318x75 | DS 8K0.05 | 640,- | 111 | ● | ● | ○ | ● | ● | | | | | | | | | | ○ |
| 0,1 0,2 | 3 6 | 300x300x110 | IOC 6K-4 | 390,- | 106 | ● | ● | ○ | ● | ● | | | | | | | | | | ○ |
| 0,1 | 3 | 230x230x106 | IFB 3K-4 | 455,- | 110 | ● | ● | ○ | ● | ● | | | | | | | | | | ○ |
| 0,1 | 3 | 230x230x106 | IFC 3K-4 | 435,- | 108 | ● | ● | ○ | ○ | ● | | | | | | | | | | ○ |
| 0,1 | 10 | 230x230x103 | DS 10K0.1S | 640,- | 111 | ● | ● | ○ | ● | ● | | | | | | | | | | ○ |
| 0,1 | 16 | 308x318x75 | DS 16K0.1 | 630,- | 111 | ● | ● | ○ | ● | ● | | | | | | | | | | ○ |
| 0,1 | 20 | 308x318x75 | DS 20K0.1 | 640,- | 111 | ● | ● | ○ | ● | ● | | | | | | | | | | ○ |
| 0,1 | 30 | 308x318x75 | DS 30K0.1 | 720,- | 111 | ● | ● | ○ | ● | ● | | | | | | | | | | ○ |
| 0,1 | 30 | 500x400x125 | DS 30K0.1L | 1150,- | 111 | ● | ● | ○ | ● | ● | | | | | | | | | | ○ |
| 0,2 0,5 | 6 15 | 300x240x110 | IOC 10K-4 | 380,- | 106 | ● | ● | ○ | ● | ● | | | | | | | | | | ○ |
| 0,2 0,5 | 6 15 | 300x300x110 | EOC 10K-4 | 330,- | 104 | ● | ● | ○ | ● | ● | | | | | | | | | | ○ |
| 0,2 0,5 | 6 15 | 318x308x88 | DE 15K0.2D | 365,- | 102 | ● | ● | ○ | ● | ● | | | | | | | | | | ○ |
| 0,2 0,5 | 6 15 | 400x300x110 | IOC 10K-4L | 420,- | 106 | ● | ● | ○ | ● | ● | | | | | | | | | | ○ |
| 0,2 | 6 | 230x230x106 | IFB 6K-4S | 390,- | 110 | ● | ● | ○ | ● | ● | | | | | | | | | | ○ |
| 0,2 | 6 | 230x230x106 | IFC 6K-4S | 435,- | 108 | ● | ● | ○ | ○ | ● | | | | | | | | | | ○ |
| 0,2 | 6 | 300x240x109 | IFB 6K-4 | 400,- | 110 | ● | ● | ○ | ● | ● | | | | | | | | | | ○ |
| 0,2 | 6 | 300x240x109 | IFC 6K-4 | 450,- | 108 | ● | ● | ○ | ○ | ● | | | | | | | | | | ○ |
| 0,2 | 6 | 300x240x109 | IXC 6K-4 | 660,- | 112 | ● | ● | ○ | ○ | ● | | | | | | | | | | ○ |
| 0,2 | 36 | 308x318x75 | DS 36K0.2 | 650,- | 111 | ● | ● | ○ | ● | ● | | | | | | | | | | ○ |
| 0,2 | 36 | 500x400x125 | DS 36K0.2L | 1070,- | 111 | ● | ● | ○ | ● | ● | | | | | | | | | | ○ |
| 0,2 | 60 | 500x400x125 | DS 60K0.2 | 1150,- | 111 | ● | ● | ○ | ● | ● | | | | | | | | | | ○ |
| 0,5 1 | 15 30 | 400x300x110 | IOC 30K-4 | 420,- | 106 | ● | ● | ○ | ● | ● | | | | | | | | | | ○ |
| 0,5 1 | 15 35 | 300x300x110 | EOC 30K-4S | 330,- | 104 | ● | ● | ○ | ● | ● | | | | | | | | | | ○ |
| 0,5 1 | 15 35 | 318x308x88 | DE 35K0.5D | 360,- | 102 | ● | ● | ○ | ● | ● | | | | | | | | | | ○ |
| 0,5 1 | 15 35 | 500x400x120 | EOC 30K-4 | 390,- | 104 | ● | ● | ○ | ● | ● | | | | | | | | | | ○ |
| 0,5 | 6 | 300x300x110 | EOC 6K-4A | 330,- | 104 | ● | ● | ○ | ● | ● | | | | | | | | | | ○ |
| 0,5 | 6 | 318x308x75 | DE 6K0.5A | 235,- | 102 | ● | ● | ○ | ● | ● | | | | | | | | | | ○ |
| 0,5 | 15 | 300x240x109 | IFB 10K-4 | 415,- | 110 | ● | ● | ○ | ● | ● | | | | | | | | | | ○ |
| 0,5 | 15 | 300x240x109 | IFC 10K-4 | 470,- | 108 | ● | ● | ○ | ○ | ● | | | | | | | | | | ○ |
| 0,5 | 15 | 300x240x109 | IXC 10K-4 | 680,- | 112 | ● | ● | ○ | ○ | ● | | | | | | | | | | ○ |
| 0,5 | 15 | 400x300x117 | IFC 10K-4L | 520,- | 108 | ● | ● | ○ | ○ | ● | | | | | | | | | | ○ |
| 0,5 | 15 | 400x300x117 | IXC 10K-4L | 740,- | 112 | ● | ● | ○ | ○ | ● | | | | | | | | | | ○ |
| 0,5 | 65 | 500x400x125 | DS 65K0.5 | 1080,- | 111 | ● | ● | ○ | ● | ● | | | | | | | | | | ○ |
| 0,5 | 100 | 500x400x125 | DS 100K0.5 | 1140,- | 111 | ● | ● | ○ | ● | ● | | | | | | | | | | ○ |
| 1 2 | 3 6 | 230x230x106 | IFB 6K-3SM | 390,- | 110 | ○ | ● | ○ | ● | ● | | | | | | | | | | ○ |
| 1 2 | 3 6 | 230x230x106 | IFC 6K1DSM | 435,- | 108 | ● | ● | ○ | ● | ● | | | | | | | | | | ○ |
| 1 2 | 3 6 | 300x240x109 | IFC 6K1DM | 440,- | 108 | ● | ● | ○ | ● | ● | | | | | | | | | | ○ |
| 1 2 | 3 6 | 300x240x109 | IXC 6K-3M | 660,- | 112 | ○ | ● | ○ | ○ | ● | | | | | | | | | | ○ |
| 1 2 | 3 6 | 300x300x110 | EOC 6K-3 | 315,- | 104 | ● | ● | ○ | ● | ● | | | | | | | | | | ○ |
| 1 2 | 3 6 | 300x300x110 | IOC 6K-3M | 390,- | 106 | ○ | ● | ○ | ○ | ● | | | | | | | | | | ○ |
| 1 2 | 3 6 | 318x308x75 | DE 6K1D | 205,- | 102 | ● | ● | ○ | ● | ● | | | | | | | | | | ○ |
| 1 2 | 30 60 | 300x300x110 | EOC 60K-3 | 330,- | 104 | ● | ● | ○ | ● | ● | | | | | | | | | | ○ |
| 1 2 | 30 60 | 318x308x88 | DE 60K1D | 360,- | 102 | ● | ● | ○ | ● | ● | | | | | | | | | | ○ |
| 1 2 | 30 60 | 400x300x110 | IOC 60K-3 | 430,- | 106 | ● | ● | ○ | ○ | ● | | | | | | | | | | ○ |
| 1 2 | 30 60 | 500x400x120 | EOC 60K-3L | 400,- | 104 | ● | ● | ○ | ● | ● | | | | | | | | | | ○ |
| 1 2 | 30 60 | 500x400x120 | IOC 60K-3L | 510,- | 106 | ● | ● | ○ | ○ | ● | | | | | | | | | | ○ |
| 1 2 | 30 60 | 522x406x98 | DE 60K1DL | 480,- | 102 | ● | ● | ○ | ● | ● | | | | | | | | | | ○ |
| 1 | 12 | 300x300x110 | EOC 10K-3A | 330,- | 104 | ● | ● | ○ | ● | ● | | | | | | | | | | ○ |
| 1 | 12 | 318x308x75 | DE 12K1A | 230,- | 102 | ● | ● | ○ | ● | ● | | | | | | | | | | ○ |
| 1 | 30 | 400x300x117 | IFC 30K-3 | 540,- | 108 | ● | ● | ○ | ○ | ● | | | | | | | | | | ○ |
| 1 | 30 | 400x300x117 | IXC 30K-3 | 720,- | 112 | ● | ● | ○ | ○ | ● | | | | | | | | | | ○ |
| 1 | 30 | 500x400x127 | IXC 30K-3L | 860,- | 112 | ● | ● | ○ | ○ | ● | | | | | | | | | | ○ |
| 1 | 150 | 500x400x125 | DS 150K1 | 1140,- | 111 | ● | ● | ○ | ● | ● | | | | | | | | | | ○ |
| 2 5 | 6 12 | 300x300x110 | EOC 10K-3 | 320,- | 104 | ● | ● | ○ | ● | ● | | | | | | | | | | ○ |
| 2 5 | 6 15 | 300x240x109 | IFC 15K2DM | 500,- | 108 | ● | ● | ○ | ○ | ● | | | | | | | | | | ○ |
| 2 5 | 6 15 | 300x240x109 | IXC 10K-3M | 680,- | 112 | ○ | ● | ○ | ○ | ● | | | | | | | | | | ○ |
| 2 5 | 6 15 | 300x240x110 | IOC 10K-3M | 360,- | 106 | ○ | ● | ○ | ○ | ● | | | | | | | | | | ○ |
| 2 5 | 6 15 | 318x308x75 | DE 15K2D | 205,- | 102 | ● | ● | ○ | ● | ● | | | | | | | | | | ○ |
| 2 5 | 6 15 | 400x300x110 | IOC 10K-3LM | 405,- | 106 | ○ | ● | ○ | ○ | ● | | | | | | | | | | ○ |
| 2 5 | 6 15 | 400x300x117 | IFC 15K2DLM | 550,- | 108 | ● | ● | ○ | ○ | ● | | | | | | | | | | ○ |
| 2 5 | 6 15 | 400x300x117 | IXC 10K-3LM | 740,- | 112 | ○ | ● | ○ | ○ | ● | | | | | | | | | | ○ |
| 2 5 | 60 150 | 300x300x110 | EOC 100K-3 | 335,- | 104 | ● | ● | ○ | ● | ● | | | | | | | | | | ○ |
| 2 5 | 60 150 | 318x308x88 | DE 150K2D | 365,- | 102 | ● | ● | ○ | ● | ● | | | | | | | | | | ○ |
| 2 5 | 60 150 | 500x400x120 | EOC 100K-3L | 430,- | 104 | ● | ● | ○ | ● | ● | | | | | | | | | | ○ |
| 2 5 | 60 150 | 500x400x120 | IOC 100K-3 | 520,- | 106 | ● | ● | ○ | ○ | ● | | | | | | | | | | ○ |
| 2 5 | 60 150 | 522x406x98 | DE 150K2DL | 490,- | 102 | ● | ● | ○ | ○ | ● | | | | | | | | | | ○ |
| 2 5 | 60 150 | 650x500x150 | IOC 100K-3L | 700,- | 106 | ● | ● | ○ | ○ | ● | | | | | | | | | | ○ |
| 2 | 6 | 300x240x109 | SFE 6K-3NM | 490,- | 114 | ○ | ● | ○ | ○ | ● | | | | | | | | | | ○ |
| 2 | 24 | 300x300x110 | EOC 20K-3A | 330,- | 104 | ● | ● | ○ | ● | ● | | | | | | | | | | ○ |

Quick-Finder Parcel Scales/Platform Scales

| Readability | Weighing capacity [Max] | Weighing plate W×D×H mm | Model | Price excl. of VAT ex works € | Page |  | | | | | | | | | | |
|-------------|-------------------------|-------------------------|---------------|-------------------------------|------|--|---|---|---|---|---|---|---|---|---|---|
| [d] | kg | mm | KERN | | | For an explanation on the pictos, see the front flap | | | | | | | | | | |
| 2 | 24 | 318×308×75 | DE 24K2A | 240,- | 102 | ● | ● | ● | ● | ● | ● | ● | ● | ● | ● | ● |
| 2 | 60 | 400×300×117 | IFC 60K-3 | 550,- | 108 | ● | ● | ○ | ○ | ● | ● | ● | ● | ● | ● | ○ |
| 2 | 60 | 400×300×117 | IXC 60K-3 | 780,- | 112 | ● | ● | ○ | ○ | ● | ● | ● | ● | ● | ● | ○ |
| 2 | 60 | 500×400×127 | IFB 60K-3L | 650,- | 110 | ● | ● | ● | ● | ● | ● | ● | ● | ● | ● | ○ |
| 2 | 60 | 500×400×127 | IFC 60K-3L | 730,- | 108 | ● | ● | ○ | ○ | ● | ● | ● | ● | ● | ● | ○ |
| 2 | 60 | 500×400×127 | IXC 60K-3L | 870,- | 112 | ● | ● | ○ | ○ | ● | ● | ● | ● | ● | ● | ○ |
| 5 10 | 15 30 | 400×300×110 | IOC 30K-3M | 410,- | 106 | ○ | ● | ● | ○ | ● | ● | ● | ● | ● | ● | ○ |
| 5 10 | 15 30 | 400×300×117 | IFB 30K5DM | 520,- | 110 | ○ | ● | ● | ● | ● | ● | ● | ● | ● | ● | ○ |
| 5 10 | 15 30 | 400×300×117 | IFC 30K5DM | 540,- | 108 | ○ | ● | ● | ○ | ○ | ● | ● | ● | ● | ● | ○ |
| 5 10 | 15 30 | 400×300×117 | IXC 30K-3M | 720,- | 112 | ○ | ● | ● | ○ | ○ | ● | ● | ● | ● | ● | ○ |
| 5 10 | 15 30 | 500×400×127 | IXC 30K-3LM | 860,- | 112 | ○ | ● | ● | ○ | ○ | ● | ● | ● | ● | ● | ○ |
| 5 10 | 15 35 | 300×300×110 | EOC 30K-3 | 330,- | 104 | ● | ● | ● | ● | ● | ● | ● | ● | ● | ● | ○ |
| 5 10 | 15 35 | 318×308×75 | DE 35K5D | 210,- | 102 | ● | ● | ● | ● | ● | ● | ● | ● | ● | ● | ○ |
| 5 10 | 15 35 | 500×400×120 | EOC 30K-3L | 390,- | 104 | ● | ● | ● | ● | ● | ● | ● | ● | ● | ● | ○ |
| 5 10 | 15 35 | 522×403×83 | DE 35K5DL | 350,- | 102 | ● | ● | ● | ● | ● | ● | ● | ● | ● | ● | ○ |
| 5 10 | 150 300 | 500×400×120 | EOC 300K-3 | 400,- | 104 | ● | ● | ● | ● | ● | ● | ● | ● | ● | ● | ○ |
| 5 10 | 150 300 | 522×406×98 | DE 300K5DL | 490,- | 102 | ● | ● | ● | ● | ● | ● | ● | ● | ● | ● | ○ |
| 5 10 | 150 300 | 650×500×150 | IOC 300K-3 | 720,- | 106 | ● | ● | ○ | ○ | ● | ● | ● | ● | ● | ● | ○ |
| 5 | 15 | 300×240×109 | SFE 10K-3NM | 475,- | 114 | ○ | ● | ● | ● | ● | ● | ● | ● | ● | ● | ○ |
| 5 | 15 | 315×305×57 | EOE 10K-3 | 170,- | 99 | ● | ● | ● | ● | ● | ● | ● | ● | ● | ● | ○ |
| 5 | 15 | 315×305×57 | EOB 15K5 | 175,- | 100 | ● | ● | ● | ● | ● | ● | ● | ● | ● | ● | ○ |
| 5 | 15 | 400×300×117 | SFE 10K-3LNM | 560,- | 114 | ○ | ● | ● | ● | ● | ● | ● | ● | ● | ● | ○ |
| 5 | 60 | 300×300×110 | EOC 60K-3A | 340,- | 104 | ● | ● | ● | ● | ● | ● | ● | ● | ● | ● | ○ |
| 5 | 60 | 318×308×75 | DE 60K5A | 235,- | 102 | ● | ● | ● | ● | ● | ● | ● | ● | ● | ● | ○ |
| 5 | 150 | 500×400×127 | IFB 100K-3 | 650,- | 110 | ● | ● | ● | ● | ● | ● | ● | ● | ● | ● | ○ |
| 5 | 150 | 500×400×127 | IFC 150K-3 | 690,- | 108 | ● | ● | ○ | ○ | ● | ● | ● | ● | ● | ● | ○ |
| 5 | 150 | 500×400×127 | IXC 100K-3 | 850,- | 112 | ● | ● | ○ | ○ | ● | ● | ● | ● | ● | ● | ○ |
| 5 | 150 | 650×500×139 | IXC 100K-3L | 1010,- | 112 | ● | ● | ○ | ○ | ● | ● | ● | ● | ● | ● | ○ |
| 5 | 150 | 650×500×139 | IFB 100K-3L | 800,- | 110 | ● | ● | ● | ● | ● | ● | ● | ● | ● | ● | ○ |
| 5 | 150 | 650×500×139 | IFC 150K-3L | 890,- | 108 | ● | ● | ○ | ○ | ● | ● | ● | ● | ● | ● | ○ |
| 10 20 | 30 60 | 300×300×110 | EOC 60K-2 | 340,- | 104 | ● | ● | ● | ● | ● | ● | ● | ● | ● | ● | ○ |
| 10 20 | 30 60 | 318×308×75 | DE 60K10D | 205,- | 102 | ● | ● | ● | ● | ● | ● | ● | ● | ● | ● | ○ |
| 10 20 | 30 60 | 400×300×110 | IOC 60K-2M | 410,- | 106 | ○ | ● | ● | ○ | ● | ● | ● | ● | ● | ● | ○ |
| 10 20 | 30 60 | 400×300×117 | IFB 60K10DM | 520,- | 110 | ○ | ● | ● | ● | ● | ● | ● | ● | ● | ● | ○ |
| 10 20 | 30 60 | 400×300×117 | IFC 60K10DM | 550,- | 108 | ○ | ● | ● | ○ | ○ | ● | ● | ● | ● | ● | ○ |
| 10 20 | 30 60 | 400×300×117 | IXC 60K-2M | 780,- | 112 | ○ | ● | ● | ○ | ○ | ● | ● | ● | ● | ● | ○ |
| 10 20 | 30 60 | 500×400×120 | EOC 60K-2L | 380,- | 104 | ● | ● | ● | ● | ● | ● | ● | ● | ● | ● | ○ |
| 10 20 | 30 60 | 500×400×120 | IOC 60K-2LM | 500,- | 106 | ○ | ● | ● | ○ | ○ | ● | ● | ● | ● | ● | ○ |
| 10 20 | 30 60 | 500×400×127 | IFB 60K10DLM | 670,- | 110 | ○ | ● | ● | ○ | ○ | ● | ● | ● | ● | ● | ○ |
| 10 20 | 30 60 | 500×400×127 | IFC 60K10DLM | 730,- | 108 | ○ | ● | ● | ○ | ○ | ● | ● | ● | ● | ● | ○ |
| 10 20 | 30 60 | 500×400×127 | IXC 60K-2LM | 870,- | 112 | ○ | ● | ● | ○ | ○ | ● | ● | ● | ● | ● | ○ |
| 10 20 | 30 60 | 522×403×83 | DE 60K10DL | 360,- | 102 | ● | ● | ● | ● | ● | ● | ● | ● | ● | ● | ○ |
| 10 20 | 300 600 | 800×600×200 | IOC 600K-2 | 870,- | 106 | ● | ● | ○ | ○ | ● | ● | ● | ● | ● | ● | ○ |
| 10 | 30 | 300×240×109 | SFE 30K-2NM | 490,- | 114 | ○ | ● | ● | ● | ● | ● | ● | ● | ● | ● | ○ |
| 10 | 35 | 315×305×57 | EOE 30K-2 | 170,- | 99 | ● | ● | ● | ● | ● | ● | ● | ● | ● | ● | ○ |
| 10 | 35 | 315×305×57 | EOB 35K10 | 175,- | 100 | ● | ● | ● | ● | ● | ● | ● | ● | ● | ● | ○ |
| 10 | 120 | 318×308×75 | DE 120K10A | 240,- | 102 | ● | ● | ● | ● | ● | ● | ● | ● | ● | ● | ○ |
| 10 | 120 | 500×400×120 | EOC 100K-2A | 395,- | 104 | ● | ● | ● | ● | ● | ● | ● | ● | ● | ● | ○ |
| 10 | 300 | 650×500×139 | IXC 300K-3 | 1200,- | 112 | ● | ● | ○ | ○ | ● | ● | ● | ● | ● | ● | ○ |
| 10 | 300 | 650×500×139 | IFB 300K-2 | 920,- | 110 | ● | ● | ● | ● | ● | ● | ● | ● | ● | ● | ○ |
| 10 | 300 | 650×500×139 | IFC 300K-2 | 900,- | 108 | ● | ● | ○ | ○ | ● | ● | ● | ● | ● | ● | ○ |
| 20 50 | 60 150 | 300×300×110 | EOC 100K-2 | 335,- | 104 | ● | ● | ● | ● | ● | ● | ● | ● | ● | ● | ○ |
| 20 50 | 60 150 | 318×308×75 | DE 150K20D | 215,- | 102 | ● | ● | ● | ● | ● | ● | ● | ● | ● | ● | ○ |
| 20 50 | 60 150 | 500×400×120 | EOC 100K-2L | 380,- | 104 | ● | ● | ● | ● | ● | ● | ● | ● | ● | ● | ○ |
| 20 50 | 60 150 | 500×400×120 | IOC 100K-2M | 500,- | 106 | ○ | ● | ● | ○ | ○ | ● | ● | ● | ● | ● | ○ |
| 20 50 | 60 150 | 500×400×127 | IFB 150K20DM | 650,- | 110 | ○ | ● | ● | ○ | ○ | ● | ● | ● | ● | ● | ○ |
| 20 50 | 60 150 | 500×400×127 | IFC 150K20DM | 690,- | 108 | ○ | ● | ● | ○ | ○ | ● | ● | ● | ● | ● | ○ |
| 20 50 | 60 150 | 500×400×127 | IXC 100K-2M | 850,- | 112 | ○ | ● | ● | ○ | ○ | ● | ● | ● | ● | ● | ○ |
| 20 50 | 60 150 | 522×403×83 | DE 150K20DL | 350,- | 102 | ● | ● | ● | ● | ● | ● | ● | ● | ● | ● | ○ |
| 20 50 | 60 150 | 600×500×150 | EOC 100K-2XL | 560,- | 104 | ● | ● | ● | ● | ● | ● | ● | ● | ● | ● | ○ |
| 20 50 | 60 150 | 650×500×139 | IXC 100K-2LM | 1010,- | 112 | ○ | ● | ● | ○ | ○ | ● | ● | ● | ● | ● | ○ |
| 20 50 | 60 150 | 650×500×139 | IFB 150K20DLM | 870,- | 110 | ○ | ● | ● | ○ | ○ | ● | ● | ● | ● | ● | ○ |
| 20 50 | 60 150 | 650×500×139 | IFC 150K20DLM | 900,- | 108 | ○ | ● | ● | ○ | ○ | ● | ● | ● | ● | ● | ○ |
| 20 50 | 60 150 | 650×500×150 | IOC 100K-2LM | 700,- | 106 | ○ | ● | ● | ○ | ○ | ● | ● | ● | ● | ● | ○ |
| 20 50 | 60 150 | 650×500×89 | DE 150K20DXL | 500,- | 102 | ● | ● | ● | ● | ● | ● | ● | ● | ● | ● | ○ |
| 20 50 | 60 150 | 950×500×60 | EOC 100K-2XXL | 580,- | 104 | ● | ● | ● | ● | ● | ● | ● | ● | ● | ● | ○ |
| 20 | 60 | 315×305×57 | EOE 60K-2 | 170,- | 99 | ● | ● | ● | ● | ● | ● | ● | ● | ● | ● | ○ |
| 20 | 60 | 315×305×57 | EOB 60K20 | 175,- | 100 | ● | ● | ● | ● | ● | ● | ● | ● | ● | ● | ○ |
| 20 | 60 | 400×300×117 | SFE 60K-2NM | 550,- | 114 | ○ | ● | ● | ● | ● | ● | ● | ● | ● | ● | ○ |
| 20 | 60 | 500×400×127 | SFE 60K-2LNM | 670,- | 114 | ○ | ● | ● | ● | ● | ● | ● | ● | ● | ● | ○ |
| 20 | 60 | 550×550×58 | EOE 60K-2L | 285,- | 99 | ● | ● | ● | ● | ● | ● | ● | ● | ● | ● | ○ |

Quick-Finder Parcel Scales/Platform Scales

| Readability | Weighing capacity | Weighing plate | Model | Price | Page |  | | | | | | | | | | | | |
|-------------|-------------------|----------------|----------------|--------------|------|--|---|---|---|---|---|---|---|---|---|---|--|---|
| [d] | [Max] | W×D×H | KERN | excl. of VAT | | For an explanation on the pictos, see the front flap | | | | | | | | | | | | |
| g | kg | mm | | € | | | | | | | | | | | | | | |
| 20 | 60 | 550×550×58 | EOB 60K20L | 350,- | 100 | ● | | | | | | | | | | | | ● |
| 20 | 600 | 800×600×192 | IFC 600K-2 | 1090,- | 108 | ● | ● | ○ | ○ | ● | ● | ● | ● | ● | ● | | | ○ |
| 20 | 600 | 800×600×192 | IFB 600K-2 | 1240,- | 110 | ● | | ● | | ● | ● | ● | ● | ● | ● | | | ○ |
| 50 100 | 150 300 | 500×400×120 | EOC 300K-2 | 400,- | 104 | ● | | ● | | ● | ● | ● | ● | ● | ● | | | ○ |
| 50 100 | 150 300 | 522×403×83 | DE 300K50D | 350,- | 102 | ● | | ● | | ● | ● | ● | ● | ● | ● | ● | | ○ |
| 50 100 | 150 300 | 600×500×150 | EOC 300K-2L | 580,- | 104 | ● | | ● | | ● | ● | ● | ● | ● | ● | | | ○ |
| 50 100 | 150 300 | 650×500×139 | IXC 300K-2M | 1200,- | 112 | ○ | ● | | ○ | ○ | ● | ● | ● | ● | ● | | | ○ |
| 50 100 | 150 300 | 650×500×139 | IFB 300K50DM | 840,- | 110 | ○ | ● | | ● | | ● | ● | ● | ● | ● | | | ○ |
| 50 100 | 150 300 | 650×500×139 | IFC 300K50DM | 900,- | 108 | ○ | ● | ● | ○ | ○ | ● | ● | ● | ● | ● | | | ○ |
| 50 100 | 150 300 | 650×500×150 | IOC 300K-2M | 720,- | 106 | ○ | ● | | ● | ○ | ● | ● | ● | ● | ● | | | ○ |
| 50 100 | 150 300 | 650×500×90 | DE 300K50DL | 500,- | 102 | ● | | ● | | ● | ● | ● | ● | ● | ● | | | ○ |
| 50 | 150 | 315×305×57 | EOE 100K-2 | 170,- | 99 | ● | | | | | | | | | | | | ● |
| 50 | 150 | 315×305×57 | EOB 150K50 | 175,- | 100 | ● | | | | | | | | | | | | ● |
| 50 | 150 | 500×400×127 | SFE 100K-2NM | 580,- | 114 | ○ | ● | | | | | | | | ● | | | ● |
| 50 | 150 | 500×400×127 | SFE 100K-2LNM | 650,- | 114 | ○ | ● | | | | | | | | ● | | | ● |
| 50 | 150 | 550×550×58 | EOE 150K50L | 290,- | 99 | ● | | | | | | | | | | | | ● |
| 50 | 150 | 550×550×58 | EOB 150K50L | 350,- | 100 | ● | | | | | | | | | | | | ● |
| 50 | 150 | 650×500×139 | SFE 100K-2XLNM | 930,- | 114 | ○ | ● | | | | | | | | ● | | | ● |
| 50 | 150 | 950×500×58 | EOE 150K50XL | 315,- | 99 | ● | | | | | | | | | | | | ● |
| 50 | 150 | 950×500×58 | EOB 150K50XL | 425,- | 100 | ● | | | | | | | | | | | | ● |
| 50 | 150 | 950×500×58 | EOS 150K50XL | 470,- | 101 | ● | | | | | | | | | | | | ● |
| 100 200 | 300 600 | 800×600×192 | IFC 600K100DM | 1090,- | 108 | ○ | ● | ● | ○ | ○ | ● | ● | ● | ● | ● | | | ○ |
| 100 200 | 300 600 | 800×600×192 | IFB 600K-1M | 1310,- | 110 | ○ | ● | | ● | | ● | ● | ● | ● | ● | | | ○ |
| 100 200 | 300 600 | 800×600×200 | IOC 600K-1M | 840,- | 106 | ○ | ● | | ● | ○ | ● | ● | ● | ● | ● | | | ○ |
| 100 | 300 | 315×305×57 | EOE 300K100 | 170,- | 99 | ● | | | | | | | | | | | | ● |
| 100 | 300 | 315×305×57 | EOB 300K100A | 175,- | 100 | ● | | | | | | | | | | | | ● |
| 100 | 300 | 550×550×58 | EOE 300K100L | 285,- | 99 | ● | | | | | | | | | | | | ● |
| 100 | 300 | 550×550×58 | EOB 300K100L | 350,- | 100 | ● | | | | | | | | | | | | ● |
| 100 | 300 | 650×500×139 | SFE 300K-1LNM | 910,- | 114 | ○ | ● | | | | | | | | ● | | | ● |
| 100 | 300 | 950×500×58 | EOE 300K100XL | 320,- | 99 | ● | | | | | | | | | | | | ● |
| 100 | 300 | 950×500×58 | EOB 300K100XL | 425,- | 100 | ● | | | | | | | | | | | | ● |
| 100 | 300 | 950×500×58 | EOS 300K100XL | 470,- | 101 | ● | | | | | | | | | | | | ● |

News 2025

● Standard ○ Option



Parcel scales with big platform for fast and easy weighing in the office, production, dispatch etc.

| Features | Technical data | Accessories |
|--|---|---|
| <ul style="list-style-type: none"> Thanks to battery operation, compact, lightweight construction, it is suitable for the use in several locations Wall mount for display device, standard Hold function: When the weighing conditions are unstable, a stable weight is calculated determining an average value | <ul style="list-style-type: none"> Large LCD display, digit height 25 mm Weighing platform dimensions, steel, lacquered <ul style="list-style-type: none"> A W×D×H 315×305×57 mm B W×D×H 550×550×58 mm, see larger picture C W×D×H 950×500×58 mm Dimensions of display device W×D×H 235×114×51 mm Optional battery operation, 4×1.5 V AA not included in scope of delivery, operating time up to 100 h Permissible ambient temperature 5 °C/35 °C | <ul style="list-style-type: none"> Protective working cover over the display device, scope of delivery 5 items, KERN EOB-A04BS05, € 44,- Stand to elevate display device, and screwed onto the platform, height of stand approx. 480 mm, for models with weighing plate size A KERN EOB-A01N, € 70,- Stand to elevate display device, height of stand approx. 1000 mm, KERN EOB-A02B, € 112,- 1 Non-slip rubber mat, W×D×H 945×505×5 mm, KERN EOE-A01, € 50,- |

10

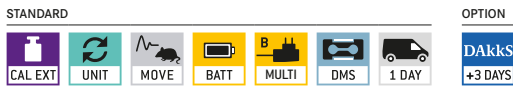

| Model | Weighing capacity [Max] kg | Readability [d] g | Reproducibility g | Linearity g | Net weight approx. kg | Weighing plate | Price excl. of VAT ex works € | Options | |
|---------------|----------------------------|-------------------|-------------------|-------------|-----------------------|----------------|-------------------------------|---------------------------|--------------|
| | | | | | | | | DAKKS Calibr. Certificate | DAKKS KERN € |
| KERN | | | | | | | | | |
| EOE 10K-3 | 15 | 5 | 5 | ± 10 | 4,0 | A | 170,- | 963-128 | 124,- |
| EOE 30K-2 | 35 | 10 | 10 | ± 20 | 4,0 | A | 170,- | 963-128 | 124,- |
| EOE 60K-2 | 60 | 20 | 20 | ± 40 | 4,0 | A | 170,- | 963-129 | 153,- |
| EOE 60K-2L | 60 | 20 | 20 | ± 40 | 14 | B | 285,- | 963-129 | 153,- |
| EOE 100K-2 | 150 | 50 | 50 | ± 100 | 4,0 | A | 170,- | 963-129 | 153,- |
| EOE 150K50L | 150 | 50 | 50 | ± 100 | 14 | B | 290,- | 963-129 | 153,- |
| EOE 150K50XL | 150 | 50 | 50 | ± 100 | 18 | C | 315,- | 963-129 | 153,- |
| EOE 300K100 | 300 | 100 | 100 | ± 200 | 4,0 | A | 170,- | 963-129 | 153,- |
| EOE 300K100L | 300 | 100 | 100 | ± 200 | 14 | B | 285,- | 963-129 | 153,- |
| EOE 300K100XL | 300 | 100 | 100 | ± 200 | 18 | C | 320,- | 963-129 | 153,- |



Allround parcel scale with robust stainless steel weighing plate – also with XL platform and large weighing ranges

Features

- Weighing plate stainless steel, painted steel base
- Simple and convenient 4-key operation
- Wall mount for display device, standard
- Hold function: When the weighing conditions are unstable, a stable weight is calculated determining an average value
- Protective working cover included with delivery
- Universal external mains adapter included with delivery

Technical data

- Large LCD display, digit height 25 mm
- Weighing platform dimensions, stainless steel
 - A** W×D×H 315×305×57 mm
 - B** W×D×H 550×550×58 mm, see larger picture
 - C** W×D×H 950×500×58 mm
- Dimensions of display device W×D×H 235×114×51 mm
- Optional battery operation, 4×1.5 V AA not included in scope of delivery, operating time up to 60 h
- Permissible ambient temperature 5 °C/35 °C

Accessories

- Protective working cover over the display device, scope of delivery 5 items, KERN EOB-A04BS05, **€ 44,-**
- **1** Stand to elevate display device, and screwed onto the platform, height of stand approx. 480 mm, for models with weighing plate size **A** KERN EOB-A01N, **€ 70,-**
- **2** Stand to elevate display device, height of stand approx. 1000 mm, KERN EOB-A02B, **€ 112,-**
- **3** Non-slip rubber mat, W×D×H 945×505×5 mm, KERN EOE-A01, **€ 50,-**

STANDARD



OPTION



| Model | Weighing capacity [Max] kg | Readability [d] g | Reproducibility g | Linearity g | Cable length (Spiral cable) approx. m | Net weight approx. kg | Weighing plate | Price excl. of VAT ex works € | Options | |
|----------------------|----------------------------|-------------------|-------------------|-------------|---------------------------------------|-----------------------|----------------|-------------------------------|---------------------------|--------------|
| | | | | | | | | | DAkKS Calibr. Certificate | DAkKS KERN € |
| EOB 15K5 | 15 | 5 | 5 | ± 10 | 1,8 | 3,8 | A | 175,- | 963-128 | 124,- |
| EOB 35K10 | 35 | 10 | 10 | ± 20 | 1,8 | 3,8 | A | 175,- | 963-128 | 124,- |
| EOB 60K20 | 60 | 20 | 20 | ± 40 | 1,8 | 3,8 | A | 175,- | 963-129 | 153,- |
| EOB 60K20L | 60 | 20 | 20 | ± 40 | 2,7 | 13 | B | 350,- | 963-129 | 153,- |
| EOB 150K50 | 150 | 50 | 50 | ± 100 | 1,8 | 3,8 | A | 175,- | 963-129 | 153,- |
| EOB 150K50L | 150 | 50 | 50 | ± 100 | 2,7 | 13 | B | 350,- | 963-129 | 153,- |
| EOB 150K50XL | 150 | 50 | 50 | ± 100 | 2,7 | 17 | C | 425,- | 963-129 | 153,- |
| EOB 300K100A | 300 | 100 | 100 | ± 200 | 1,8 | 3,8 | A | 175,- | 963-129 | 153,- |
| EOB 300K100L | 300 | 100 | 100 | ± 200 | 2,7 | 13 | B | 350,- | 963-129 | 153,- |
| EOB 300K100XL | 300 | 100 | 100 | ± 200 | 2,7 | 17 | C | 425,- | 963-129 | 153,- |



Heavy duty parcel and veterinary platform scale with extra large stainless steel weighing plate

Features

- Weighing plate stainless steel, painted steel base
- Simple and convenient 4-key operation
- Wall mount for display device, standard
- Hold function: When the weighing conditions are unstable, a stable weight is calculated determining an average value
- **1** The scale can be easily transported using rollers and a handle and does not require much storage space
- Protective working cover included with delivery
- Non-slip rubber mat included with delivery
- Universal external mains adapter included with delivery

Technical data

- Large LCD display, digit height 25 mm
- Weighing platform dimensions, stainless steel, W×D×H 950×500×58 mm
- Dimensions of display device W×D×H 235×114×51 mm
- Cable length display device, spiral cable, approx. 2,7 m
- Optional battery operation, 4×1.5 V AA not included in scope of delivery, operating time up to 60 h
- Permissible ambient temperature 5 °C/35 °C

Accessories

- Protective working cover over the display device, scope of delivery 5 items, KERN EOB-A04BS05, **€ 44,-**
- **2** Stand to elevate display device, height of stand approx. 1000 mm, KERN EOB-A02B, **€ 112,-**

STANDARD



OPTION



| Model | Weighing capacity [Max] kg | Readability [d] g | Reproducibility g | Linearity g | Net weight approx. kg | Price excl. of VAT ex works € | Options | |
|---------------|----------------------------|-------------------|-------------------|-------------|-----------------------|-------------------------------|---------|---------------------------|
| | | | | | | | DAkKS | DAkKS Calibr. Certificate |
| KERN | | | | | | | KERN | € |
| EOS 150K50XL | 150 | 50 | 50 | ± 100 | 19 | 470,- | 963-129 | 153,- |
| EOS 300K100XL | 300 | 100 | 100 | ± 200 | 19 | 470,- | 963-129 | 153,- |



10 The long lasting story of success with dust and spray protected display device

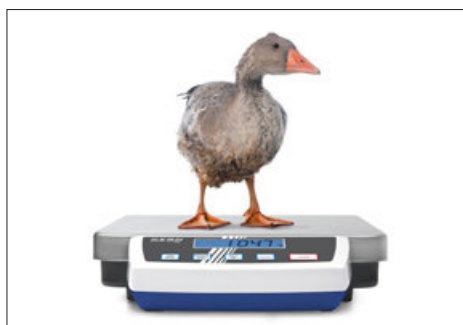

Animal weighing



Recipe-weighing



Piece counting



Features

- Thanks to battery operation/rechargeable battery operation (optional), compact, lightweight construction, it is suitable for the use in several locations
- Display device: Plastics, protection against dust and water splashes IP65, flexible positioning
- Weighing plate stainless steel, painted steel base
- PRE-TARE function for manual subtraction of a known container weight, useful for checking fill-levels
- With the recipe function you can weigh the different ingredients of a mixture. As a check, you can also call up the total weight of all the ingredients
- Freely programmable weighing unit, e.g. display direct in special units such as length of thread g/m, paper weight g/m², or similar
- Protective working cover included with delivery

Technical data

- Large backlit LCD display, digit height 25 mm
- Weighing platform dimensions, stainless steel
 - A** W×D×H 318×308×75 mm
 - B** W×D×H 318×308×88 mm
 - C** W×D×H 522×403×83 mm, see larger picture
 - D** W×D×H 522×406×98 mm
 - E** W×D×H 650×500×89 mm
- Dimensions of display device W×D×H 225×110×55 mm
- Optional battery operation, 9 V block not included in scope of delivery, operating time up to 12 h
- Permissible ambient temperature 5 °C/35 °C

Accessories

- Protective working cover over the display device, scope of delivery 5 items, KERN DE-A12S05, **€ 44,-**
- Internal rechargeable battery pack, operating time up to 30 h without backlight, charging time approx. 10 h, KERN NDE-A02, **€ 60,-**
- Wall mount for display device, KERN DE-A13, **€ 32,-**
- **2** Stand to elevate display device, Height of stand approx. 480 mm, KERN DE-A10, **€ 128,-**
- Suitable for models with weighing plate size **C**, **D**, **E**: Mount to fasten the display device to the platform, KERN DE-A11N, **€ 40,-**
- Individual header data: the free software SHM-01 can be used to print 4 header lines on the printout when using printer YKN-01
- Further details, plenty of further accessories and suitable printers see *Accessories*

STANDARD

OPTION

| Model | Weighing capacity [Max] kg | Readability [d] g | Reproducibility g | Linearity g | Smallest part weight (Normal) g/piece | Cable length approx. m | Net weight approx. kg | Weighing plate | Price excl. of VAT ex works | Options | |
|--|----------------------------|-------------------|-------------------|-------------|---------------------------------------|------------------------|-----------------------|----------------|-----------------------------|---------|----------------------------|
| | | | | | | | | | | DAKKS | Calibr. Certificate KERN € |
| Multi-division balance with high resolution readability, with increasing or decreasing load, it switches automatically to the next largest or smallest weighing range [Max] and readout [d]. | | | | | | | | | | | |
| DE 15K0.2D | 6 15 | 0,2 0,5 | 0,2 0,5 | ± 0,8 2 | 4 | 1 | 4,0 | B | 365,- | 963-128 | 124,- |
| DE 35K0.5D | 15 35 | 0,5 1 | 0,5 1 | ± 2 4 | 10 | 1 | 7 | B | 360,- | 963-128 | 124,- |
| DE 60K1D | 30 60 | 1 2 | 1 2 | ± 4 8 | 20 | 1,47 | 7 | B | 360,- | 963-129 | 153,- |
| DE 60K1DL | 30 60 | 1 2 | 1 2 | ± 4 8 | 20 | 1,4 | 15 | D | 480,- | 963-129 | 153,- |
| DE 150K2D | 60 150 | 2 5 | 2 5 | ± 8 20 | 40 | 1,6 | 7 | B | 365,- | 963-129 | 153,- |
| DE 150K2DL | 60 150 | 2 5 | 2 5 | ± 8 20 | 40 | 1,4 | 15 | D | 490,- | 963-129 | 153,- |
| DE 300K5DL | 150 300 | 5 10 | 5 10 | ± 20 40 | 100 | 1,4 | 15 | D | 490,- | 963-129 | 153,- |
| Multi-division balance without high resolution readability | | | | | | | | | | | |
| DE 6K1D | 3 6 | 1 2 | 1 2 | ± 3 6 | 40 | 1,4 | 4,8 | A | 205,- | 963-128 | 124,- |
| DE 15K2D | 6 15 | 2 5 | 2 5 | ± 6 15 | 100 | 1,4 | 4,8 | A | 205,- | 963-128 | 124,- |
| DE 35K5D | 15 35 | 5 10 | 5 10 | ± 15 30 | 100 | 1,4 | 4,8 | A | 210,- | 963-128 | 124,- |
| DE 35K5DL | 15 35 | 5 10 | 5 10 | ± 15 30 | 100 | 1,4 | 16 | C | 350,- | 963-128 | 124,- |
| DE 60K10D | 30 60 | 10 20 | 10 20 | ± 30 60 | 200 | 1,4 | 4,8 | A | 205,- | 963-129 | 153,- |
| DE 60K10DL | 30 60 | 10 20 | 10 20 | ± 30 60 | 200 | 1,4 | 16 | C | 360,- | 963-129 | 153,- |
| DE 150K20D | 60 150 | 20 50 | 20 50 | ± 60 150 | 400 | 1,5 | 5,0 | A | 215,- | 963-129 | 153,- |
| DE 150K20DL | 60 150 | 20 50 | 20 50 | ± 60 150 | 400 | 1,5 | 16 | C | 350,- | 963-129 | 153,- |
| DE 150K20DXL | 60 150 | 20 50 | 20 50 | ± 60 150 | 400 | 1,4 | 19 | E | 500,- | 963-129 | 153,- |
| DE 300K50DL | 150 300 | 50 100 | 50 100 | ± 150 300 | 2000 | 1,05 | 28 | E | 500,- | 963-129 | 153,- |
| DE 300K50D | 150 300 | 50 100 | 50 100 | ± 150 300 | 2000 | 1,25 | 16 | C | 350,- | 963-129 | 153,- |
| DE 6K0.5A | 6 | 0,5 | 0,5 | ± 1,5 | 10 | 1,4 | 4,8 | A | 235,- | 963-128 | 124,- |
| DE 12K1A | 12 | 1 | 1 | ± 3 | 20 | 1,4 | 4,8 | A | 230,- | 963-128 | 124,- |
| DE 24K2A | 24 | 2 | 2 | ± 6 | 40 | 1,4 | 4,8 | A | 240,- | 963-128 | 124,- |
| DE 60K5A | 60 | 5 | 5 | ± 15 | 100 | 1,4 | 4,8 | A | 235,- | 963-129 | 153,- |
| DE 120K10A | 120 | 10 | 10 | ± 30 | 200 | 1,4 | 5,0 | A | 240,- | 963-129 | 153,- |

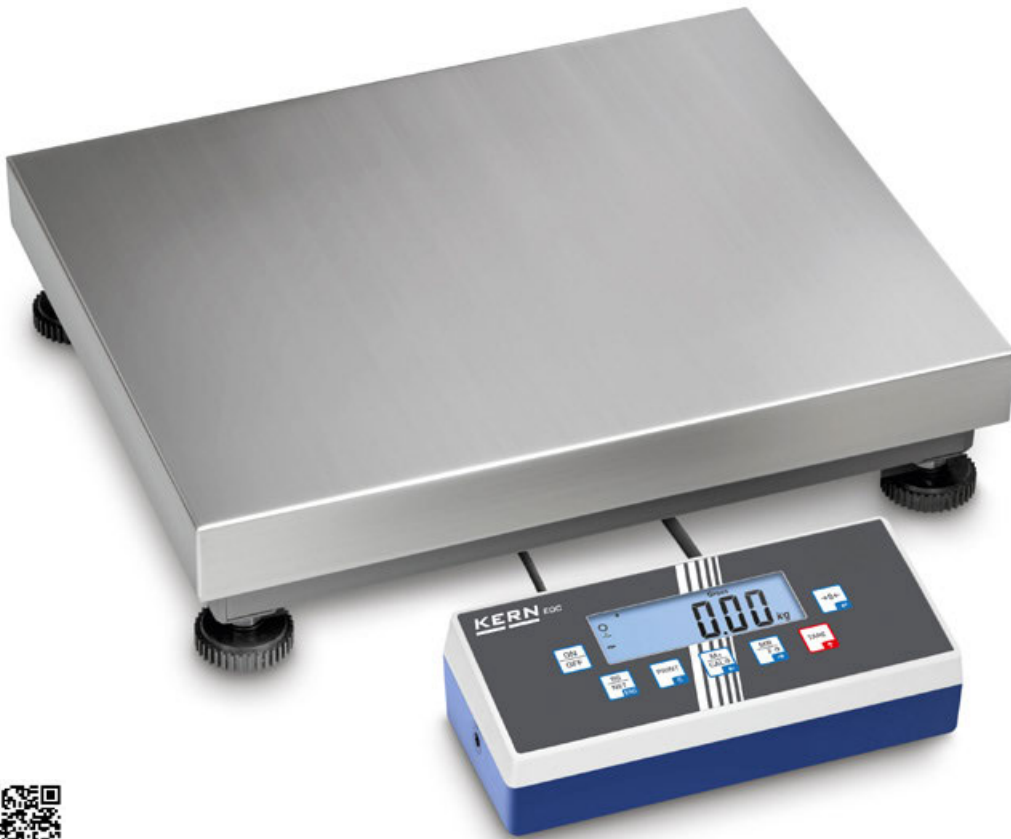

Robust and high-resolution platform scale with practical Flip/Flop display device for greatest ease of use

10



Weighing instead of counting! Because the counting function is so easy to use, you can rapidly record large numbers of small parts – which saves time and money



Practical Flip/Flop display device: flexible positioning e.g. free-standing or screwed to the wall (optional). By rotating the upper housing shell you can determine the angle of the display as well as the cable outlet. Factory Option for an additional cost, delivery time + 2 working days, KERN KIB-M01, see *Accessories* on the right, please indicate when placing your order

Features

- Thanks to rechargeable battery operation (optional), compact, lightweight construction, it is suitable for the use in several locations
- **Platform:** weighing plate of stainless steel, painted steel base, silicone-coated aluminium load cell with protection against dust and water splashes IP65. Level indicator and levelling feet for precise levelling of the scale, fitted as standard, to give the most accurate weighing result
- Weighing with tolerance range: a visual and audible signal helps with portioning, dispensing or grading
- Hold function: When the weighing conditions are unstable, a stable weight is calculated determining an average value
- Benchtop stand incl. wall mount for display device as standard
- Protective working cover included with delivery
- KERN Communication Protocol (KCP): The KCP permits searching and remote control of the balance using external control devices or computers



Technical data

- Large backlit LCD display, digit height 25 mm
- Weighing platform dimensions W×D×H, stainless steel
A 300×300×110 mm **B** 500×400×120 mm
C 600×500×150 mm **D** 950×500×60 mm
- Dimensions of display device W×D×H 268×115×80 mm
- Permissible ambient temperature -10 °C/40 °C

Accessories

- Protective working cover, scope of delivery 5 items, KERN EOC-A01S05, **€ 55,-**
- Internal rechargeable battery pack, operating time up to 43 h without backlight, charging time approx. 3 h, KERN KFB-A01, **€ 40,-**
- **2** Suitable for models with weighing plate size **A - C**: Stand, to be screwed onto the platform, height of stand approx.330 mm, KERN EOC-A05, **€ 65,-**
- **3** Mount to fasten the display device to the platform, KERN EOC-A03, **€ 33,-**

- Benchtop stand incl. wall mount for display device, KERN EOC-A04, **€ 33,-**
- Modification of the display device, to move the cable outlet to the front of the display device, ideal e.g. for subsequent wall installation of the display device (standard configuration ex works: rear outlet), Factory Option, delivery time + 2 working days, KERN KIB-M01, **€ 104,-**

STANDARD



OPTION



| Model | Weighing capacity [Max] kg | Readability [d] g | Reproducibility g | Linearity g | Smallest part weight (Normal) g/piece | Cable length Spiral cable** approx. m | Net weight approx. kg | Weighing plate | Price excl. of VAT ex works € | Options | |
|--|----------------------------|-------------------|-------------------|-------------|---------------------------------------|---------------------------------------|-----------------------|----------------|-------------------------------|------------|-----------------------|
| | | | | | | | | | | DAkKS KERN | Calibr. Certificate € |
| Multi-range balance with high-resolution display, with increasing load it switches automatically to the next largest weighing range [Max] and readout [d] and when the load is fully removed, the balance switches back to the lower range | | | | | | | | | | | |
| EOC 10K-4 | 6 15 | 0,2 0,5 | 0,2 0,5 | ± 0,6 1,5 | 5 | 3 | 6 | A | 330,- | 963-128 | 124,- |
| EOC 30K-4S | 15 35 | 0,5 1 | 0,5 1 | ± 1,5 3 | 10 | 3 | 6 | A | 330,- | 963-128 | 124,- |
| EOC 30K-4 | 15 35 | 0,5 1 | 0,5 1 | ± 1,5 3 | 10 | 3 | 9 | B | 390,- | 963-128 | 124,- |
| EOC 60K-3 | 30 60 | 1 2 | 1 2 | ± 3 6 | 20 | 3 | 7 | A | 330,- | 963-129 | 153,- |
| EOC 60K-3L | 30 60 | 1 2 | 1 2 | ± 3 6 | 20 | 3 | 9 | B | 400,- | 963-129 | 153,- |
| EOC 100K-3 | 60 150 | 2 5 | 2 5 | ± 6 15 | 50 | 3 | 6 | A | 335,- | 963-129 | 153,- |
| EOC 100K-3L | 60 150 | 2 5 | 2 5 | ± 6 15 | 50 | 3 | 9 | B | 430,- | 963-129 | 153,- |
| EOC 300K-3 | 150 300 | 5 10 | 5 10 | ± 15 30 | 100 | 3 | 9 | B | 400,- | 963-129 | 153,- |
| Multi-range balance without high-resolution display | | | | | | | | | | | |
| EOC 6K-3 | 3 6 | 1 2 | 1 2 | ± 3 6 | 2,5 | 3 | 6 | A | 315,- | 963-128 | 124,- |
| EOC 10K-3* | 6 12 | 2 5 | 2 5 | ± 6 15 | 5 | 3 | 6 | A | 320,- | 963-128 | 124,- |
| EOC 30K-3 | 15 35 | 5 10 | 5 10 | ± 15 30 | 10 | 3 | 6 | A | 330,- | 963-128 | 124,- |
| EOC 30K-3L | 15 35 | 5 10 | 5 10 | ± 15 30 | 10 | 3 | 9 | B | 390,- | 963-128 | 124,- |
| EOC 60K-2 | 30 60 | 10 20 | 10 20 | ± 30 60 | 20 | 3 | 7 | A | 340,- | 963-129 | 153,- |
| EOC 60K-2L | 30 60 | 10 20 | 10 20 | ± 30 60 | 20 | 3 | 9 | B | 380,- | 963-129 | 153,- |
| EOC 100K-2 | 60 150 | 20 50 | 20 50 | ± 60 150 | 50 | 3 | 6 | A | 335,- | 963-129 | 153,- |
| EOC 100K-2L | 60 150 | 20 50 | 20 50 | ± 60 150 | 50 | 3 | 9 | B | 380,- | 963-129 | 153,- |
| EOC 100K-2XL | 60 150 | 20 50 | 20 50 | ± 60 150 | 50 | 3 | 19 | C | 560,- | 963-129 | 153,- |
| EOC 100K-2XXL | 60 150 | 20 50 | 20 50 | ± 60 150 | 100 | **2,7 | 17 | D | 580,- | 963-129 | 153,- |
| EOC 300K-2 | 150 300 | 50 100 | 50 100 | ± 150 300 | 100 | 3 | 9 | B | 400,- | 963-129 | 153,- |
| EOC 300K-2L | 150 300 | 50 100 | 50 100 | ± 150 300 | 100 | 3 | 19 | C | 580,- | 963-129 | 153,- |
| EOC 6K-4A | 6 | 0,5 | 0,5 | ± 1,5 | 2,5 | 3 | 6 | A | 330,- | 963-128 | 124,- |
| EOC 10K-3A | 12 | 1 | 1 | ± 3 | 5 | 3 | 7 | A | 330,- | 963-128 | 124,- |
| EOC 20K-3A* | 24 | 2 | 2 | ± 6 | 10 | 3 | 6 | A | 330,- | 963-128 | 124,- |
| EOC 60K-3A | 60 | 5 | 5 | ± 15 | 20 | 3 | 7 | A | 340,- | 963-129 | 153,- |
| EOC 100K-2A | 120 | 10 | 10 | ± 30 | 50 | 3 | 9 | B | 395,- | 963-129 | 153,- |

! * ONLY WHILE STOCKS LAST



Allround platform scale with a wide range of communication options, verification optional – also available as high-resolution version with fine display

10



1 Verification plug, for verified balances this enables you to separate the display device and platform without affecting the verification, e.g. for installing the scale in a packing and dispatch table, pit frame etc. at a later date. Please order this at the same time as you purchase your scale, see *Accessories*



Practical Flip/Flop display device: flexible positioning e.g. free-standing or screwed to the wall (optional). By rotating the upper housing shell you can determine the angle of the display as well as the cable outlet. Factory Option for an additional cost, delivery time + 2 working days, KERN KIB-M01, see *Accessories* on the right, please indicate when placing your order

Features

- A wide range of (optional) data interfaces allows easy transfer of weighing data to tablets, laptops, PCs, networks, smartphones, printers, etc.
- KERN Communication Protocol (KCP): The KCP permits searching and remote control of the balance using external control devices or computers. Only possible through data interface RS-232, other interfaces on request., for details see page 19
- Standardised, simplified concept of operation
- Thanks to rechargeable battery operation (optional), compact, lightweight construction, it is suitable for the use in several locations
- Platform: weighing plate of stainless steel, painted steel base, silicone-coated aluminium load cell with protection against dust and water splashes IP65
- Level indicator and levelling feet for precise levelling of the scale, fitted as standard, to give the most accurate weighing result

Technical data

- Large LCD display, digit height 25 mm
- Weighing platform dimensions W×D×H, stainless steel
 - A** 300×240×110 mm **B** 300×300×110 mm
 - C** 400×300×110 mm **D** 500×400×120 mm
 - E** 650×500×150 mm **F** 800×600×200 mm

- Dimensions of display device W×D×H 268×115×80 mm
- Cable length of display device approx. 3 m
- Permissible ambient temperature -10 °C/40 °C

Accessories

- Protective working cover, scope of delivery 5 items, KERN EOC-A01S05, **€ 55,-**
- Stand, to be screwed onto the platform, height of stand approx.330 mm, KERN EOC-A05, **€ 65,-**
- Mount to fasten the display device to the platform, KERN EOC-A03, **€ 33,-**
- Benchttop stand incl. wall mount for display device, KERN EOC-A04, **€ 33,-**
- Internal rechargeable battery pack, operating time up to 26 h with backlight, charging time approx. 3 h, KERN KFB-A01, **€ 40,-**
- USB data interface, for transferring weighing to the PC, printer etc., must be ordered at purchase, KERN KIB-A03, **€ 120,-**
- Bluetooth data interface for wireless data transfer to PC or tablets, must be ordered at purchase, KERN KIB-A04, **€ 110,-**
- WiFi interface for wireless connection of the balance to networks and WiFi capable devices, such as tablets, laptops or smartphones, continuous data transfer, must be ordered at purchase, KERN KIB-A10, **€ 130,-**

- Ethernet data interface, to connect an IP-based Ethernet network, continuous data transfer, must be ordered at purchase, KERN KIB-A02, **€ 165,-**
- Signal lamp, including interface, for visual support of weighing with tolerance range, must be ordered at purchase, KERN KIB-A06, **€ 470,-**
- **1** Verification plug, for verified balances this enables you to separate the display device and platform without affecting the verification, e.g. for installing the scale in a packing and dispatch table, pit frame etc. at a later date. Please order this at the same time as you purchase your scale, KERN KIB-A12, **€ 164,-**
- **2** Alibi memory, for paperless archiving of the weighing results with ID no., gross/net/tare value, date and time, must be ordered at purchase, KERN KIB-A13, **€ 164,-**
- Alibi memory, including USB interface for exporting weighing results to external data storage media, such as, for example, USB sticks, hard drives, etc., must be ordered at purchase, KERN KIB-A01, **€ 175,-**
- Modification of the display device, to move the cable outlet to the front of the display device, ideal e.g. for subsequent wall installation of the display device (standard configuration ex works: rear outlet), Factory Option, delivery time + 2 working days, KERN KIB-M01, **€ 104,-**

3 Note: In addition to the RS-232 data interface, which is integrated as standard, only one other data interface can be installed and operated

STANDARD

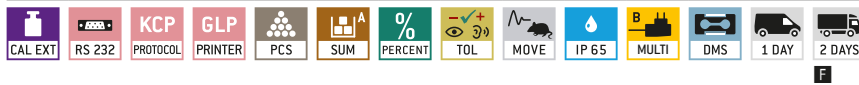

OPTION



FACTORY



| Model | Weighing capacity [Max] [kg] | Readability [d] | Verification value [e] | Minimal load [Min] | Net weight approx. | Weighing plate | Price excl. of VAT ex works € | Options | | | |
|--|------------------------------|-----------------|------------------------|--------------------|--------------------|----------------|-------------------------------|--------------|-------|-------------|-------|
| | | | | | | | | Verification | DAkks | Certificate | |
| KERN | kg | g | g | g | kg | | € | KERN | € | KERN | € |
| Multi-range balance with high-resolution display, with increasing load it switches automatically to the next largest weighing range [Max] and readout [d] and when the load is fully removed, the balance switches back to the lower range | | | | | | | | | | | |
| IOC 6K-4 | 3 6 | 0,1 0,2 | - | 20 40 | 6 | B | 390,- | - | - | 963-128 | 124,- |
| IOC 10K-4 | 6 15 | 0,2 0,5 | - | 40 100 | 6 | A | 380,- | - | - | 963-128 | 124,- |
| IOC 10K-4L | 6 15 | 0,2 0,5 | - | 40 100 | 8 | C | 420,- | - | - | 963-128 | 124,- |
| IOC 30K-4 | 15 30 | 0,5 1 | - | 100 200 | 8 | C | 420,- | - | - | 963-128 | 124,- |
| IOC 60K-3 | 30 60 | 1 2 | - | 200 400 | 8 | C | 430,- | - | - | 963-129 | 153,- |
| IOC 60K-3L | 30 60 | 1 2 | - | 200 400 | 12 | D | 510,- | - | - | 963-129 | 153,- |
| IOC 100K-3 | 60 150 | 2 5 | - | 400 1000 | 12 | D | 520,- | - | - | 963-129 | 153,- |
| IOC 100K-3L | 60 150 | 2 5 | - | 400 1000 | 22 | E | 700,- | - | - | 963-129 | 153,- |
| IOC 300K-3 | 150 300 | 5 10 | - | 1000 2000 | 22 | E | 720,- | - | - | 963-129 | 153,- |
| IOC 600K-2 | 300 600 | 10 20 | - | 2000 4000 | 32 | F | 870,- | - | - | 963-130 | 215,- |
| Multi-range balance without high-resolution display | | | | | | | | | | | |
| IOC 6K-3M | 3 6 | 1 2 | 1 2 | 20 40 | 6 | B | 390,- | 965-228 | 84,- | 963-128 | 124,- |
| IOC 10K-3M | 6 15 | 2 5 | 2 5 | 40 100 | 6 | A | 360,- | 965-228 | 84,- | 963-128 | 124,- |
| IOC 10K-3LM | 6 15 | 2 5 | 2 5 | 40 100 | 8 | C | 405,- | 965-228 | 84,- | 963-128 | 124,- |
| IOC 30K-3M | 15 30 | 5 10 | 5 10 | 100 200 | 8 | C | 410,- | 965-228 | 84,- | 963-128 | 124,- |
| IOC 60K-2M | 30 60 | 10 20 | 10 20 | 200 400 | 8 | C | 410,- | 965-229 | 110,- | 963-129 | 153,- |
| IOC 60K-2LM | 30 60 | 10 20 | 10 20 | 200 400 | 12 | D | 500,- | 965-229 | 110,- | 963-129 | 153,- |
| IOC 100K-2M | 60 150 | 20 50 | 20 50 | 400 1000 | 12 | D | 500,- | 965-229 | 110,- | 963-129 | 153,- |
| IOC 100K-2LM | 60 150 | 20 50 | 20 50 | 400 1000 | 22 | E | 700,- | 965-229 | 110,- | 963-129 | 153,- |
| IOC 300K-2M | 150 300 | 50 100 | 50 100 | 1000 2000 | 22 | E | 720,- | 965-229 | 110,- | 963-129 | 153,- |
| IOC 600K-1M | 300 600 | 100 200 | 100 200 | 2000 4000 | 32 | F | 840,- | 965-230 | 158,- | 963-130 | 215,- |

Note: For devices that require verification (conformity assessment according to NAWI 2014/31/EU), please include the verification when placing your order. The initial verification is not possible after delivery. Please inform the full address of the location of use for the initial verification.

2 It is essential that a verified balance which transfers measurements to external devices using an interface, has an alibi memory (KIB-A13). It is not possible to upgrade later

1 ONLY WHILE STOCKS LAST



The new IFC: Robust industrial scales with up to three interfaces, with optional verification

Features

- Tough industry standard suitable for use in harsh industrial applications
- Standardised, convenient KERN concept of operation, consistency across products in terms of design, menu structure, button functions, interface connection and interface protocol
- KERN Universal Port (KUP): permits the connection of an external KUP interface adapter, such as, for example, RS-232, USB, Bluetooth, WiFi or Ethernet, for the exchange of data and control commands, without any installation outlay. Available as an option: RS-232, USB, Ethernet, WiFi, Bluetooth
- Each interface can be set up separately, e.g.:
 - Interface 1 (WiFi): Continuous sending to a PC for documentation of a process
 - Interface 2 (RS-232): Print stable weight
 - Interface 3 (analogue module): Controlling a device when the target weight is reached
- With Real Time Clock as standard: Enables you to log the weighing results with accurate time information. Even if the power supply is interrupted, the balance can continue to work with the correct time

- Available as an option with alibi memory for paperless archiving of weighing results. This also means the results of weighings with mandatory verification can be electronically evaluated and processed further
- KERN Communication Protocol (KCP): The KCP permits searching and remote control of the balance using external control devices or computers
- Simplified battery replacement through easily-accessible housing. Particularly advantageous for models with optional verification, as the verification seal remains intact
- Platform: weighing plate of stainless steel, painted steel base, silicone-coated aluminium load cell with protection against dust and water splashes IP65
- Benchttop stand incl. wall mount for display device as standard
- Protective working cover included with delivery

Technical data

- Large backlit LCD display, digit height 48 mm
- Weighing platform dimensions
 - A** W×D×H 230×230×106 mm
 - B** W×D×H 300×240×109 mm
 - C** W×D×H 400×300×117 mm (see larger picture)
 - D** W×D×H 500×400×127 mm
 - E** W×D×H 650×500×139 mm
 - F** W×D×H 800×600×192 mm
- Dimensions of display device W×D×H 220×145×65 mm
- Cable length of display device approx. 3 m
- Permissible ambient temperature -10 °C/40 °C



Accessories

- Protective working cover, scope of delivery 5 items, KERN YBA-A18S05, € 52,-
- Internal rechargeable battery pack, operating time up to 48 h without backlight, charging time approx. 8 h, KERN YKR-01, € 35,-
- **1** Stand to elevate display device, height of stand approx. 1040 mm, KERN BFS-A07, € 170,-
- Column for screwing the display device to the platform, for models with weighing plate size **A - F** Height of stand approx. 330 mm, KERN IFB-A01, € 68,-
- **C, D, E, F** Height of stand approx. 600 mm, KERN IFB-A02, € 81,-
- RS-232 interface adapter, KERN KUP-01, € 60,-

- USB interface adapter, KERN KUP-03, € 75,-
- Ethernet interface adapter, KERN KUP-04, € 115,-
- WiFi interface adapter, KERN KUP-05, € 75,-
- Bluetooth interface adapter, KERN KUP-06, € 99,-
- Analogue module, KERN KUP-08, € 170,-
- **2** * Extension box for connecting up to three interfaces in parallel, KERN KUP-13, € 75,-
- Memory module (alibi memory), KERN YMM-04, € 80,-
- ESD drain to protect against electrostatic discharge e.g. for electrostatically-charged weighing objects or people who work with the scale, KERN YGR-01, € 60,-

- Signal lamp for visual support of weighing with tolerance range, connection is only possible in combination with KUP-01 (RS-232 interface), KERN CFS-A03, € 310,-
- **3** Roller conveyor attachment, with smooth-running, hot-dip galvanised steel rollers with ball bearings, robust aluminium profile frame for models ≥30 kg [Max] with weighing plate size **C** KERN YRO-01, € 830,-
- **D** KERN YRO-02, € 870,-
- **E** KERN YRO-03, € 1200,-

STANDARD

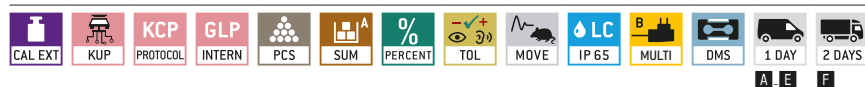

OPTION



| Model | Weighing capacity [Max] kg | Readability [d] g | Verification value [e] g | Minimal load [Min] g | Net weight approx. kg | Weighing plate | Price excl. of VAT ex works € | Options | | | |
|-------------|----------------------------|-------------------|--------------------------|----------------------|-----------------------|----------------|-------------------------------|-------------------|---|------------|---------------|
| | | | | | | | | Verification KERN | € | DAkkS KERN | Certificate € |
| IFC 3K-4 | 3 | 0,1 | - | - | 4,6 | A | 435,- | - | - | 963-127 | 103,- |
| IFC 6K-4S | 6 | 0,2 | - | - | 4,6 | A | 435,- | - | - | 963-128 | 124,- |
| IFC 6K-4 | 6 | 0,2 | - | - | 5,0 | B | 450,- | - | - | 963-128 | 124,- |
| IFC 10K-4 | 15 | 0,5 | - | - | 5,0 | B | 470,- | - | - | 963-128 | 124,- |
| IFC 10K-4L | 15 | 0,5 | - | - | 8 | C | 520,- | - | - | 963-128 | 124,- |
| IFC 30K-3 | 30 | 1 | - | - | 8 | C | 540,- | - | - | 963-128 | 124,- |
| IFC 60K-3 | 60 | 2 | - | - | 7 | C | 550,- | - | - | 963-129 | 153,- |
| IFC 60K-3L | 60 | 2 | - | - | 10 | D | 730,- | - | - | 963-129 | 153,- |
| IFC 150K-3 | 150 | 5 | - | - | 11 | D | 690,- | - | - | 963-129 | 153,- |
| IFC 150K-3L | 150 | 5 | - | - | 18 | E | 890,- | - | - | 963-129 | 153,- |
| IFC 300K-2 | 300 | 10 | - | - | 20 | E | 900,- | - | - | 963-129 | 153,- |
| IFC 600K-2 | 600 | 20 | - | - | 40 | F | 1090,- | - | - | 963-130 | 215,- |

Multi-range balance, with increasing load it switches automatically to the next largest weighing range [Max] and readout [d] and when the load is fully removed, the balance switches back to the lower range

| | | | | | | | | | | | |
|---------------|-----------|-----------|-----------|-------------|-----|---|--------|---------|-------|---------|-------|
| IFC 6K1DSM | 3 6 | 1 2 | 1 2 | 20 40 | 4,6 | A | 435,- | 965-228 | 84,- | 963-128 | 124,- |
| IFC 6K1DM | 3 6 | 1 2 | 1 2 | 20 40 | 6 | B | 440,- | 965-228 | 84,- | 963-128 | 124,- |
| IFC 15K2DM | 6 15 | 2 5 | 2 5 | 40 100 | 5,0 | B | 500,- | 965-228 | 84,- | 963-128 | 124,- |
| IFC 15K2DLM | 6 15 | 2 5 | 2 5 | 40 100 | 7 | C | 550,- | 965-228 | 84,- | 963-128 | 124,- |
| IFC 30K5DM | 15 30 | 5 10 | 5 10 | 100 200 | 8 | C | 540,- | 965-228 | 84,- | 963-128 | 124,- |
| IFC 60K10DM | 30 60 | 10 20 | 10 20 | 200 400 | 7 | C | 550,- | 965-229 | 110,- | 963-129 | 153,- |
| IFC 60K10DLM | 30 60 | 10 20 | 10 20 | 200 400 | 10 | D | 730,- | 965-229 | 110,- | 963-129 | 153,- |
| IFC 150K20DM | 60 150 | 20 50 | 20 50 | 400 1000 | 10 | D | 690,- | 965-229 | 110,- | 963-129 | 153,- |
| IFC 150K20DLM | 60 150 | 20 50 | 20 50 | 400 1000 | 20 | E | 900,- | 965-229 | 110,- | 963-129 | 153,- |
| IFC 300K50DM | 150 300 | 50 100 | 50 100 | 1000 2000 | 20 | E | 900,- | 965-229 | 110,- | 963-129 | 153,- |
| IFC 600K100DM | 300 600 | 100 200 | 100 200 | 2000 4000 | 44 | F | 1090,- | 965-230 | 158,- | 963-130 | 215,- |

Note: For devices that require verification (conformity assessment according to NAWI 2014/31/EU), please include the verification when placing your order. The initial verification is not possible after delivery. Please inform the full address of the location of use for the initial verification.

New model



High-resolution industrial scale in heavy version, now also up to [Max] 600 kg, verification optional

Features

- Platform: weighing plate of stainless steel, painted steel base, silicone-coated aluminium load cell with protection against dust and water splashes IP65
- Benchtop stand incl. wall mount for display device as standard
- Protective working cover included with delivery

Technical data

- Backlit LCD display, digit height 52 mm
- Weighing platform dimensions W×D×H, stainless steel
 - A** 230×230×106 mm **D** 300×240×109 mm
 - C** 400×300×114 mm **E** 500×400×127 mm
 - F** 650×500×139 mm **F** 800×600×192 mm
- Dimensions of display device W×D×H 250×160×58 mm



- Cable length of display device approx. 3 m
- Permissible ambient temperature -10 °C/40 °C

Accessories

- Protective working cover over the display device, scope of delivery 5 items, KERN KFB-A02S05, € 52,-
- T** Stand to elevate display device, for models with weighing plate size **A-E**: Height of stand approx. 330 mm, KERN IFB-A01, € 68,-
D-F: Height of stand approx. 600 mm, KERN IFB-A02, € 81,-
- A-F**: Stand to elevate display device, height of stand approx. 1040 mm, KERN BFS-A07, € 170,-
- Internal rechargeable battery pack, operating time up to 35 h without backlight, charging time approx. 12 h, must be ordered at purchase, KERN KFB-A01, € 40,-
- Bluetooth data interface for wireless data transfer to PC or tablets, must be ordered at purchase, not in combination with verification. When installing the Bluetooth data interface, the RS-232 data interface can no longer be used, KERN KFB-A03, € 160,-
- Analogue module, not possible in combination with signal lamp or rechargeable battery pack 0-10 V: KERN KFB-A04, € 170,-
4-20 mA: KERN KFB-A05, € 170,-

STANDARD

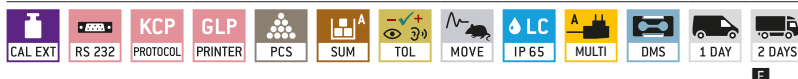

OPTION



FACTORY



| Model | Weighing capacity [Max] kg | Readability [d] g | Verification value [e] g | Minimal load [Min] g | Net weight approx. kg | Weighing plate | Price excl. of VAT ex works € | Options | | | |
|-------------|----------------------------|-------------------|--------------------------|----------------------|-----------------------|----------------|-------------------------------|--------------|------|---------------------------|-------|
| | | | | | | | | Verification | € | DAkKS Calibr. Certificate | |
| KERN | | | | | | | | M III | KERN | DAkKS KERN | € |
| IFB 3K-4 | 3 | 0,1 | - | - | 4,6 | A | 455,- | - | - | 963-127 | 103,- |
| IFB 6K-4S | 6 | 0,2 | - | - | 4,6 | A | 390,- | - | - | 963-128 | 124,- |
| IFB 6K-4 | 6 | 0,2 | - | - | 5,0 | B | 400,- | - | - | 963-128 | 124,- |
| IFB 10K-4 | 15 | 0,5 | - | - | 5,0 | B | 415,- | - | - | 963-128 | 124,- |
| IFB 60K-3L | 60 | 2 | - | - | 11 | D | 650,- | - | - | 963-129 | 153,- |
| IFB 100K-3 | 150 | 5 | - | - | 11 | D | 650,- | - | - | 963-129 | 153,- |
| IFB 100K-3L | 150 | 5 | - | - | 18 | E | 800,- | - | - | 963-129 | 153,- |
| IFB 300K-2 | 300 | 10 | - | - | 20 | E | 920,- | - | - | 963-129 | 153,- |
| IFB 600K-2 | 600 | 20 | - | - | 40 | F | 1240,- | - | - | 963-130 | 215,- |

Multi-range balance, with increasing load it switches automatically to the next largest weighing range [Max] and readout [d] and when the load is fully removed, the balance switches back to the lower range

| | | | | | | | | | | | |
|---------------|-----------|-----------|-----------|-------------|-----|----------|--------|---------|-------|---------|-------|
| IFB 6K-3SM | 3 6 | 1 2 | 1 2 | 20 40 | 4,6 | A | 390,- | 965-228 | 84,- | 963-128 | 124,- |
| IFB 6K1DM | 3 6 | 1 2 | 1 2 | 20 40 | 6 | B | 400,- | 965-228 | 84,- | 963-128 | 124,- |
| IFB 15K2DM | 6 15 | 2 5 | 2 5 | 40 100 | 5,0 | B | 435,- | 965-228 | 84,- | 963-128 | 124,- |
| IFB 15K2DLM | 6 15 | 2 5 | 2 5 | 40 100 | 7 | C | 550,- | 965-228 | 84,- | 963-128 | 124,- |
| IFB 30K5DM | 15 30 | 5 10 | 5 10 | 100 200 | 8 | C | 520,- | 965-228 | 84,- | 963-128 | 124,- |
| IFB 60K10DM | 30 60 | 10 20 | 10 20 | 200 400 | 7 | C | 520,- | 965-229 | 110,- | 963-129 | 153,- |
| IFB 60K10DLM | 30 60 | 10 20 | 10 20 | 200 400 | 11 | D | 670,- | 965-229 | 110,- | 963-129 | 153,- |
| IFB 150K20DM | 60 150 | 20 50 | 20 50 | 400 1000 | 11 | D | 650,- | 965-229 | 110,- | 963-129 | 153,- |
| IFB 150K20DLM | 60 150 | 20 50 | 20 50 | 400 1000 | 18 | E | 870,- | 965-229 | 110,- | 963-129 | 153,- |
| IFB 300K50DM | 150 300 | 50 100 | 50 100 | 1000 2000 | 20 | E | 840,- | 965-229 | 110,- | 963-129 | 153,- |
| IFB 600K-1M | 300 600 | 100 200 | 100 200 | 2000 4000 | 44 | F | 1310,- | 965-230 | 158,- | 963-130 | 215,- |

Note: For devices that require verification (conformity assessment according to NAWI 2014/31/EU), please include the verification when placing your order.

The initial verification is not possible after delivery. Please inform the full address of the location of use for the initial verification.

I ONLY WHILE STOCKS LAST



Precision industrial scale with laboratory accuracy, ideal for the diverse possibilities of Industry 4.0 applications

Features

- High-capacity precision balance, ideal for high volume or heavy samples
- Numerical subtraction of tare weight for known container weight. Useful for checking fill-levels
- The automatic reference weight optimisation of reference weight gradually improves the average piece weight value
- Freely programmable weighing unit, e.g. display direct in special units such as length of wire g/m, surface weight g/m², or else
- KERN Universal Port (KUP): permits the connection of an external KUP interface adapter, such as, for example, RS-232, USB, Bluetooth, WiFi or Ethernet, for the exchange of data and control commands, without any installation outlay

- KERN Communication Protocol (KCP): The KCP permits searching and remote control of the balance using external control devices or computers
- Protective working cover included with delivery

Technical data

- Large backlit LCD display, digit height 21 mm
- Weighing platform dimensions, stainless steel
 - A** W×D×H 230×230×103 mm
 - B** W×D×H 308×318×75 mm
 - C** W×D×H 500×400×125 mm, see larger picture
- Dimensions of display device W×D×H 225×115×60 mm
- Permissible ambient temperature -10 °C/40 °C

Accessories

- Internal rechargeable battery pack, operating time up to 24 h with backlight, charging time approx. 8 h, KERN YKR-01, € 35,-
- Protective working cover over the display device, scope of delivery 5 items, KERN DE-A12S05, € 44,-
- **1** Column for screwing the display device to the platform
 - B**, **C**: Height of stand approx. 480 mm, KERN DE-A10, € 128,-
 - C**: Height of stand approx. 600 mm, KERN DS-A03, € 140,-
- **B**: Mount to fasten the display device to the platform, KERN DE-A11N, € 40,-
- Wall mount for display device, KERN DE-A13, € 32,-
- **2** Set for underfloor weighing, consists of platform, bow, hook, only for models with weighing plate **B**, KERN DS-A01, € 230,-
- RS-232 interface adapter, KERN KUP-01, € 60,-
- USB interface adapter, KERN KUP-03, € 75,-
- Ethernet interface adapter, KERN KUP-04, € 115,-
- WiFi interface adapter, KERN KUP-05, € 75,-
- Bluetooth interface adapter, KERN KUP-06, € 99,-
- Extension box for connecting up to three interfaces in parallel, KERN KUP-13, € 75,-
- Further details, plenty of further accessories and suitable printers see *Accessories*

STANDARD



OPTION



| Model | Weighing capacity [Max] kg | Readability [d] g | Smallest part weight (Normal) g/piece | Resolution Points | Cable length approx. m | Net weight approx. kg | Weighing plate | Price excl. of VAT ex works € | Options | |
|--------------------|----------------------------|-------------------|---------------------------------------|-------------------|------------------------|-----------------------|----------------|-------------------------------|------------|-----------------------|
| | | | | | | | | | DAKkS KERN | Calibr. Certificate € |
| DS 3K0.01S | 3 | 0,01 | 0,1 | 300.000 | 2,5 | 4,2 | A | 710,- | 963-127 | 103,- |
| DS 5K0.05S* | 5 | 0,05 | 0,1 | 100.000 | 2,5 | 4,2 | A | 640,- | 963-127 | 103,- |
| DS 8K0.05 | 8 | 0,05 | 0,5 | 160.000 | 2,5 | 8 | B | 640,- | 963-128 | 124,- |
| DS 10K0.1S | 10 | 0,1 | 1 | 100.000 | 2,5 | 4,2 | A | 640,- | 963-128 | 124,- |
| DS 16K0.1 | 16 | 0,1 | 1 | 160.000 | 2,5 | 8 | B | 630,- | 963-128 | 124,- |
| DS 20K0.1 | 20 | 0,1 | 1 | 200.000 | 2,5 | 8 | B | 640,- | 963-128 | 124,- |
| DS 30K0.1 | 30 | 0,1 | 1 | 300.000 | 2,5 | 8 | B | 720,- | 963-128 | 124,- |
| DS 30K0.1L | 30 | 0,1 | 1 | 300.000 | 2,5 | 19 | C | 1150,- | 963-128 | 124,- |
| DS 36K0.2 | 36 | 0,2 | 1 | 180.000 | 2,5 | 10 | B | 650,- | 963-128 | 124,- |
| DS 36K0.2L | 36 | 0,2 | 1 | 180.000 | 2,5 | 19 | C | 1070,- | 963-128 | 124,- |
| DS 60K0.2 | 60 | 0,2 | 2 | 300.000 | 2,5 | 19 | C | 1150,- | 963-129 | 153,- |
| DS 65K0.5 | 65 | 0,5 | 5 | 130.000 | 2,5 | 19 | C | 1080,- | 963-129 | 153,- |
| DS 100K0.5 | 100 | 0,5 | 5 | 200.000 | 2,5 | 19 | C | 1140,- | 963-129 | 153,- |
| DS 150K1 | 150 | 1 | 10 | 150.000 | 2,5 | 19 | C | 1140,- | 963-129 | 153,- |

! * ONLY WHILE STOCKS LAST



10 Convenience for industry: Stainless steel platform scales with up to four interfaces and intuitive operation, with optional verification

Features

- Tough industry standard suitable for use in harsh industrial applications
- Standardised, convenient KERN concept of operation, consistency across products in terms of design, menu structure, button functions, interface connection and interface protocol
- The exchange of data and control commands is optional using up to four interfaces to suit individual requirements: two wired connections (RS-232, Ethernet, USB or analogue module) and two wireless connections (WiFi, Bluetooth)
- Each interface can be set up separately, e.g.:
 - Interface 1 (WiFi): Continuous sending to a PC for documentation of a process
 - Interface 2 (RS-232): Print stable weight
 - Interface 3 (analogue module): Controlling a device when the target weight is reached
 - Interface 4 (Bluetooth): Continuous sending to a tablet to monitor a process

- Available as an option with alibi memory for paperless archiving of weighing results. This also means the results of weighings with mandatory verification can be electronically evaluated and processed further
- KERN Communication Protocol (KCP): The KCP permits searching and remote control of the balance using external control devices or computers
- Platform: weighing plate of stainless steel, painted steel base, silicone-coated aluminium load cell with protection against dust and water splashes IP65
- Display device: stainless steel, protection against dust and water splashes IP68, integrated power supply
- Superior display size: digit height 48 mm, bright backlight for easy reading of weighing results, even in poor lighting conditions

Technical data

- Large backlit LCD display, digit height 48 mm
- Weighing platform dimensions, stainless steel
 - A** W×D×H 300×240×109 mm
 - B** W×D×H 400×300×117 mm, see larger picture
 - C** W×D×H 500×400×127 mm
 - D** W×D×H 650×500×139 mm
- Dimensions of display device W×D×H 232×150×80 mm
- Cable length of display device approx. 3 m
- Permissible ambient temperature -10 °C/40 °C



Accessories

- Internal rechargeable battery pack, operating time up to 48 h without backlight, charging time approx. 8 h, KERN YKR-01, **€ 35,-**
- Stand to elevate display device
 - 1 Height of stand approx. 330 mm, KERN IXC-A01, **€ 110,-**
 - 2 Height of stand approx. 600 mm, not suitable for models with weighing plate size **A**, KERN IXC-A02, **€ 110,-**
- Internal data interface RS-232, interface cable included, KERN KUM-01, **€ 120,-**
- Internal data interface USB, interface cable included, KERN KUM-03, **€ 120,-**
- Internal data interface Ethernet, interface cable included, KERN KUM-04, **€ 165,-**

- Internal data interface WiFi, KERN KUM-05, **€ 95,-**
- Internal data interface Bluetooth, KERN KUM-06, **€ 135,-**
- Analogue module, KERN KUM-08, **€ 145,-**
- Memory module with real time clock (alibi memory), KERN YMM-06, **€ 160,-**
- ESD drain to protect against electrostatic discharge e.g. for electrostatically-charged weighing objects or people who work with the scale, KERN YGR-01, **€ 60,-**
- Signal lamp for visual support of weighing with tolerance range, (only in combination with Data interface RS-232 KERN KUM-01), KERN CFS-A03, **€ 310,-**

- Roller conveyor attachment, with smooth-running, hot-dip galvanised steel rollers with ball bearings, robust aluminium profile frame for models with weighing plate size
 - B KERN YRO-01, **€ 830,-**
 - C KERN YRO-02, **€ 870,-**
 - D KERN YRO-03, **€ 1200,-**
- Further details, plenty of further accessories and suitable printers see *Accessories*

3 Note: only two wired connections (RS-232, Ethernet, USB or analogue module) and two wireless connections (WiFi, Bluetooth) can be used at the same time

STANDARD

CAL EXT | KCP | GLP | PCS | SUM | PERCENT | TOL | MOVE | LC | IND | 230 V | DMS | 1 DAY

OPTION

ET | DAKKS | ALIBI | RS 232 | USB | BT | WIFI | ANALOG | LAN | ACCU | +3 DAYS

FACTORY

YMM-06 | IXC-M

| Model | Weighing capacity [Max] kg | Readability [d] g | Verification value [e] g | Minimal load [Min] g | Net weight approx. kg | Weighing plate | Price excl. of VAT ex works € | Options | | | |
|------------------|----------------------------|-------------------|--------------------------|----------------------|-----------------------|----------------|-------------------------------|--------------|-------|---------------------|-------|
| | | | | | | | | Verification | DAkkS | Calibr. Certificate | |
| KERN IXC 6K-4 | 6 | 0,2 | - | - | 6 | A | 660,- | - | - | 963-128 | 124,- |
| KERN IXC 10K-4 | 15 | 0,5 | - | - | 6 | A | 680,- | - | - | 963-128 | 124,- |
| KERN IXC 10K-4L | 15 | 0,5 | - | - | 7 | B | 740,- | - | - | 963-128 | 124,- |
| KERN IXC 30K-3 | 30 | 1 | - | - | 8 | B | 720,- | - | - | 963-128 | 124,- |
| KERN IXC 30K-3L | 30 | 1 | - | - | 11 | C | 860,- | - | - | 963-128 | 124,- |
| KERN IXC 60K-3 | 60 | 2 | - | - | 7 | B | 780,- | - | - | 963-129 | 153,- |
| KERN IXC 60K-3L | 60 | 2 | - | - | 11 | C | 870,- | - | - | 963-129 | 153,- |
| KERN IXC 100K-3 | 150 | 5 | - | - | 11 | C | 850,- | - | - | 963-129 | 153,- |
| KERN IXC 100K-3L | 150 | 5 | - | - | 19 | D | 1010,- | - | - | 963-129 | 153,- |
| KERN IXC 300K-3 | 300 | 10 | - | - | 20 | D | 1200,- | - | - | 963-129 | 153,- |

Multi-range balance, with increasing load it switches automatically to the next largest weighing range [Max] and readout [d] and when the load is fully removed, the balance switches back to the lower range

| | | | | | | | | | | | |
|-------------------|-----------|----------|----------|-------------|----|---|--------|---------|-------|---------|-------|
| KERN IXC 6K-3M | 3 6 | 1 2 | 1 2 | 20 40 | 6 | A | 660,- | 965-228 | 84,- | 963-128 | 124,- |
| KERN IXC 10K-3M | 6 15 | 2 5 | 2 5 | 40 100 | 6 | A | 680,- | 965-228 | 84,- | 963-128 | 124,- |
| KERN IXC 10K-3LM | 6 15 | 2 5 | 2 5 | 40 100 | 7 | B | 740,- | 965-228 | 84,- | 963-128 | 124,- |
| KERN IXC 30K-3M | 15 30 | 5 10 | 5 10 | 100 200 | 7 | B | 720,- | 965-228 | 84,- | 963-128 | 124,- |
| KERN IXC 30K-3LM | 15 30 | 5 10 | 5 10 | 100 200 | 11 | C | 860,- | 965-228 | 84,- | 963-128 | 124,- |
| KERN IXC 60K-2M | 30 60 | 10 20 | 10 20 | 200 400 | 7 | B | 780,- | 965-229 | 110,- | 963-129 | 153,- |
| KERN IXC 60K-2LM | 30 60 | 10 20 | 10 20 | 200 400 | 11 | C | 870,- | 965-229 | 110,- | 963-129 | 153,- |
| KERN IXC 100K-2M | 60 150 | 20 50 | 20 50 | 400 1000 | 11 | C | 850,- | 965-229 | 110,- | 963-129 | 153,- |
| KERN IXC 100K-2LM | 60 150 | 20 50 | 20 50 | 400 1000 | 18 | D | 1010,- | 965-229 | 110,- | 963-129 | 153,- |
| KERN IXC 300K-2M | 150 300 | 50 100 | 50 100 | 1000 2000 | 20 | D | 1200,- | 965-229 | 110,- | 963-129 | 153,- |

Note: For devices that require verification (conformity assessment according to NAWI 2014/31/EU), please include the verification when placing your order. The initial verification is not possible after delivery. Please inform the full address of the location of use for the initial verification.



Platform scale with IP65 dust and spray protection, verification optional

Features

- Platform scale protected to IP65 with stainless steel display device, for industrial applications, hygienic and easy to clean
- 1** Platform: weighing plate of stainless steel, painted steel base, silicone-coated aluminium load cell with protection against dust and water splashes IP65
- Display device: stainless steel, protection against dust and water splashes IP65, flexible positioning, for details see KERN KFE-TM
- Weighing with tolerance range: a visual and audible signal helps with portioning, dispensing or grading
- Hold function: When the weighing conditions are unstable, a stable weight is calculated determining an average value

Technical data

- Large backlit LCD display, digit height 22 mm
- Weighing platform dimensions, stainless steel
 - A** W×D×H 300×240×109 mm, see larger picture
 - B** W×D×H 400×300×117 mm
 - C** W×D×H 500×400×127 mm
 - D** W×D×H 650×500×139 mm
- Dimensions of display device W×D×H 195×120×70 mm
- Rechargeable battery pack integrated, as standard, operating time up to 35 h without backlight, charging time approx. 12 h
- Cable length of display device approx. 3 m
- Permissible ambient temperature -10 °C/40 °C

Accessories

- Stand to elevate display device
 - 2** for models with weighing plate size **A-D**: Height of stand approx. 200 mm, KERN SFE-A01, **€ 75,-**
 - 2** for models with weighing plate size **B-D**: Height of stand approx. 400 mm, KERN SFE-A02, **€ 75,-**
 - 3** for models with weighing plate size **C-D**: Height of stand approx. 600 mm, KERN SFE-A03, **€ 95,-**
- Tare pan made from stainless steel, ideal for weighing loose small parts as well as fruits, vegetables, etc., overall dimensions W×D×H 400×300×45 mm, KERN RFS-A02, **€ 75,-**

STANDARD



OPTION



FACTORY



| Model | Weighing capacity [Max] kg | Readability [d] g | Verification value [e] g | Minimal load [Min] g | Net weight approx. kg | Weighing plate | Price excl. of VAT ex works € | Options | | | |
|----------------|----------------------------|-------------------|--------------------------|----------------------|-----------------------|----------------|-------------------------------|--------------|-------|---------------------------|-------|
| | | | | | | | | Verification | | DAkkS Calibr. Certificate | |
| KERN | | | | | | | | M | KERN | DAkkS KERN | € |
| SFE 6K-3NM | 6 | 2 | 2 | 40 | 6 | A | 490,- | 965-228 | 84,- | 963-128 | 124,- |
| SFE 10K-3NM | 15 | 5 | 5 | 100 | 6 | A | 475,- | 965-228 | 84,- | 963-128 | 124,- |
| SFE 10K-3LNM | 15 | 5 | 5 | 100 | 8 | B | 560,- | 965-228 | 84,- | 963-128 | 124,- |
| SFE 30K-2NM | 30 | 10 | 10 | 200 | 6 | A | 490,- | 965-228 | 84,- | 963-128 | 124,- |
| SFE 60K-2NM | 60 | 20 | 20 | 400 | 8 | B | 550,- | 965-229 | 110,- | 963-129 | 153,- |
| SFE 60K-2LNM | 60 | 20 | 20 | 400 | 12 | C | 670,- | 965-229 | 110,- | 963-129 | 153,- |
| SFE 100K-2NM | 150 | 50 | 50 | 1000 | 8 | B | 580,- | 965-229 | 110,- | 963-129 | 153,- |
| SFE 100K-2LNM | 150 | 50 | 50 | 1000 | 12 | C | 650,- | 965-229 | 110,- | 963-129 | 153,- |
| SFE 100K-2XLNM | 150 | 50 | 50 | 1000 | 22 | D | 930,- | 965-229 | 110,- | 963-129 | 153,- |
| SFE 300K-1LNM | 300 | 100 | 100 | 2000 | 22 | D | 910,- | 965-229 | 110,- | 963-129 | 153,- |

Note: For devices that require verification (conformity assessment according to NAWI 2014/31/EU), please include the verification when placing your order. The initial verification is not possible after delivery. Please inform the full address of the location of use for the initial verification.

11

FLOOR SCALES, PALLET SCALES, DRIVE-THROUGH SCALES

From incoming goods to production and shipping – our modern, powerful floor scales can be used everywhere and intuitively. The many clever functions will assist you in carrying out processes effectively and economically, all while meeting high requirements and saving resources.

In our floor scales product category, we offer our customers a carefully coordinated product range in the weighing range from 300 to 6,000 kg. Choose between affordable entry level models, practical built-in solutions or Premium products made from stainless steel and verified. Our floor scales stand out due to their durable industrial quality as well as reliable protection against dust and water splashes.

Industrial scales for heavy loads

When weighing large containers and heavy goods, scales must overcome different challenges. As well as correspondingly large weighing ranges, a high level of stability and sturdiness is necessary, in order to withstand the maximum loads acting on the weighing plate. Our floor scales are perfectly suited for this task, for example through generously sized struts and material thicknesses, mobile stored adjustable feet for the protection of the load cells, IP67 protection against dust and water splashes or a convenient disconnect device between the display device and platform. The latter means that you can install a verified scale in a packing and dispatch bench or a pit frame for barrier-free access at a later date. Large LCD displays make it easier to read the display even if the angle of view is not ideal. We also have pallet scales, weighing beams and drive-through scales available for versatile use.

Our recommendation: High-resolution KERN BIC floor scale with $2 \times 3,000$ [d] at the best price-to-performance ratio.

Easy integration through digital interfaces

Thanks to interfaces such as RS-232, USB, Bluetooth, WiFi, Ethernet the scale can easily be connected to existing networks. Data exchange between scale and PC or printer is easy and reliable. The standardised KCP interface (Kern Communication Protocol) takes over the searching and remote control of the scale using external control devices or computers. KCP enables you to recall and control the relevant parameters and device functions and is also compatible with the MT-SICS protocol in most cases.

Our recommendation: High-resolution multi-range pallet scale KERN UID with EC type approval [M] and various data interfaces.

The KERN calibration and verification service

In order to fulfil quality requirements in accordance with DIN EN ISO 9000ff and other standards, we can offer our customers DAkkS calibration. Calibration ensures correct, usable weighing results and makes the floor scale into a reliable measuring and testing instrument. When calibrating, deviations in the display will be identified and documented. The main points to remember are: DAkkS calibration is always sensible, when checking equipment is to be used in a QM process. While calibration is not legally regulated, verification is mandatory in different applications for example:

- In commercial trade, if the price of goods are determined by weighing results.
- In the production of pre-packaged goods
- In the pharmaceutical industry
- For official purposes.

Our recommendation: BID floor scale with EC type approval [M] and the best price-to-performance ratio – now also as a high-resolution multi-range balance.

Individual solutions for maximum efficiency

The weighing ranges of bench counting scales are often not sufficient to count large quantities, units or items on pallets. This is where high-performance counting systems come into their own, as these combine a high-precision reference scale with a high-capacity bulk scale, such as for example a floor scale, pallet scale or drive-through scale.

If you have special requirements, you can also configure your ideal scale easily and quickly so that it meets your needs. We will put your weighing combination together for you, using the components you have selected and including verification. Please contact your personal customer advisor for further information!

Quick-Finder Floor Scales/Pallet Scales/Drive-through Scales

| Readability [d] g | Weighing capacity [Max] kg | Weighing plate WxD mm | Model KERN | Price excl. of VAT ex works € | Page |  For an explanation on the pictos, see the front flap | | | | | | | | | | | | | | |
|-------------------------|-------------------------------------|--------------------------------|----------------------|--|------|--|---|---|---|---|---|---|---|---|---|---|---|---|---|---|
| 50 100 | 300 600 | 1000×1000×108 | BID 600K-1DS | 1220,- | 118 | ● | ○ | ○ | ○ | ○ | ○ | ○ | ○ | ○ | ○ | ○ | ○ | ○ | ○ | ○ |
| 50 100 | 300 600 | 1200×1500×108 | BID 600K-1D | 1650,- | 118 | ● | ○ | ○ | ○ | ○ | ○ | ○ | ○ | ○ | ○ | ○ | ○ | ○ | ○ | ○ |
| 100 200 | 300 600 | 1000×1000×108 | BID 600K-1DSM | 1220,- | 118 | ○ | ● | ○ | ○ | ○ | ○ | ○ | ○ | ○ | ○ | ○ | ○ | ○ | ○ | ○ |
| 100 200 | 300 600 | 1195×840×110 | UID 600K-1DM | 1280,- | 125 | ○ | ● | ○ | ○ | ○ | ○ | ○ | ○ | ○ | ○ | ○ | ○ | ○ | ○ | ○ |
| 100 200 | 300 600 | 1200×1500×108 | BIC 600K-1 | 1340,- | 117 | | | | | | | | | | | | | | | |
| 100 200 | 300 600 | 1200×1500×108 | BID 600K-1DM | 1650,- | 118 | ○ | ● | ○ | ○ | ○ | ○ | ○ | ○ | ○ | ○ | ○ | ○ | ○ | ○ | ○ |
| 100 200 | 300 600 | 1000×1000×108 | BIC 600K-1S | 920,- | 117 | | | | | | | | | | | | | | | |
| 100 | 300 | 1000×1000×40 | NIB 300K-1 | 870,- | 128 | | | | | | | | | | | | | | | |
| 100 200 | 600 1500 | 1000×1000×108 | BID 1T-4DS | 1250,- | 118 | ● | ○ | ○ | ○ | ○ | ○ | ○ | ○ | ○ | ○ | ○ | ○ | ○ | ○ | ○ |
| 100 200 | 600 1500 | 1200×1500×108 | BID 1T-4D | 1650,- | 118 | ● | ○ | ○ | ○ | ○ | ○ | ○ | ○ | ○ | ○ | ○ | ○ | ○ | ○ | ○ |
| 200 500 | 600 1500 | 1000×1000×108 | BID 1T-4DSM | 1250,- | 118 | ○ | ● | ○ | ○ | ○ | ○ | ○ | ○ | ○ | ○ | ○ | ○ | ○ | ○ | ○ |
| 200 500 | 600 1500 | 1190×840×110 | UID 1500K-1DM | 1260,- | 125 | ○ | ● | ○ | ○ | ○ | ○ | ○ | ○ | ○ | ○ | ○ | ○ | ○ | ○ | ○ |
| 200 500 | 600 1500 | 1200×1500×108 | BIC 1T-4 | 1300,- | 117 | | | | | | | | | | | | | | | |
| 200 500 | 600 1500 | 1200×1500×108 | BID 1T-4DM | 1650,- | 118 | ○ | ● | ○ | ○ | ○ | ○ | ○ | ○ | ○ | ○ | ○ | ○ | ○ | ○ | ○ |
| 200 500 | 600 1500 | 1000×1000×108 | BIC 1T-4S | 920,- | 117 | | | | | | | | | | | | | | | |
| 200 | 600 | 870×120×84 | UFA 600K-1S | 1140,- | 123 | ● | ○ | ○ | ○ | ○ | ○ | ○ | ○ | ○ | ○ | ○ | ○ | ○ | ○ | ○ |
| 200 | 600 | 1000×1000×108 | BID 600K-1SM | 1220,- | 118 | ○ | ● | ○ | ○ | ○ | ○ | ○ | ○ | ○ | ○ | ○ | ○ | ○ | ○ | ○ |
| 200 | 600 | 1195×840×110 | UID 600K-1M | 1220,- | 125 | ○ | ● | ○ | ○ | ○ | ○ | ○ | ○ | ○ | ○ | ○ | ○ | ○ | ○ | ○ |
| 200 | 600 | 1361×840×80 | UFC 600K-1M | 1250,- | 126 | ○ | ○ | ○ | ○ | ○ | ○ | ○ | ○ | ○ | ○ | ○ | ○ | ○ | ○ | ○ |
| 200 | 600 | 1200×1500×108 | BID 600K-1M | 1600,- | 118 | ○ | ● | ○ | ○ | ○ | ○ | ○ | ○ | ○ | ○ | ○ | ○ | ○ | ○ | ○ |
| 200 | 600 | 1600×1220×95 | NXC 600K-1M | 3890,- | 130 | ○ | ○ | ○ | ○ | ○ | ○ | ○ | ○ | ○ | ○ | ○ | ○ | ○ | ○ | ○ |
| 200 | 600 | 1361×840×80 | UXC 600K-1M | 1870,- | 127 | ○ | ○ | ○ | ○ | ○ | ○ | ○ | ○ | ○ | ○ | ○ | ○ | ○ | ○ | ○ |
| 200 | 600 | 1000×1000×85 | BFC 600K-1SM | 1420,- | 120 | ○ | ○ | ○ | ○ | ○ | ○ | ○ | ○ | ○ | ○ | ○ | ○ | ○ | ○ | ○ |
| 200 | 600 | 1000×1000×85 | BXC 600K-1SM | 3020,- | 122 | ○ | ○ | ○ | ○ | ○ | ○ | ○ | ○ | ○ | ○ | ○ | ○ | ○ | ○ | ○ |
| 200 | 600 | 1500×1250×85 | BFC 600K-1M | 1960,- | 120 | ○ | ○ | ○ | ○ | ○ | ○ | ○ | ○ | ○ | ○ | ○ | ○ | ○ | ○ | ○ |
| 200 | 600 | 1600×1220×95 | NFC 600K-1M | 1910,- | 129 | ○ | ○ | ○ | ○ | ○ | ○ | ○ | ○ | ○ | ○ | ○ | ○ | ○ | ○ | ○ |
| 200 | 600 | 1800×1420×95 | NFC 600K-1LM | 2220,- | 129 | ○ | ○ | ○ | ○ | ○ | ○ | ○ | ○ | ○ | ○ | ○ | ○ | ○ | ○ | ○ |
| 200 | 600 | 1000×1000×40 | NIB 600K-2 | 870,- | 128 | | | | | | | | | | | | | | | |
| 200 | 600 | 1195×840×110 | UIB 600K-1 | 990,- | 124 | | | | | | | | | | | | | | | |
| 200 500 | 1500 3000 | 1200×1500×108 | BID 3T-3D | 1650,- | 118 | ● | ○ | ○ | ○ | ○ | ○ | ○ | ○ | ○ | ○ | ○ | ○ | ○ | ○ | ○ |
| 200 500 | 1500 3000 | 1500×1500×108 | BID 3T-3DL | 1900,- | 118 | ● | ○ | ○ | ○ | ○ | ○ | ○ | ○ | ○ | ○ | ○ | ○ | ○ | ○ | ○ |
| 500 1000 | 1500 3000 | 1190×840×110 | UID 3000K-ODM | 1260,- | 125 | ○ | ● | ○ | ○ | ○ | ○ | ○ | ○ | ○ | ○ | ○ | ○ | ○ | ○ | ○ |
| 500 1000 | 1500 3000 | 1200×1500×108 | BIC 3T-3 | 1300,- | 117 | | | | | | | | | | | | | | | |
| 500 1000 | 1500 3000 | 1500×1500×108 | BIC 3T-3L | 1600,- | 117 | | | | | | | | | | | | | | | |
| 500 1000 | 1500 3000 | 1200×1500×108 | BID 3T-3DM | 1650,- | 118 | ○ | ● | ○ | ○ | ○ | ○ | ○ | ○ | ○ | ○ | ○ | ○ | ○ | ○ | ○ |
| 500 1000 | 1500 3000 | 1500×1500×108 | BID 3T-3DLM | 1900,- | 118 | ○ | ● | ○ | ○ | ○ | ○ | ○ | ○ | ○ | ○ | ○ | ○ | ○ | ○ | ○ |
| 500 | 1500 | 1000×1000×108 | BID 1T-4SM | 1220,- | 118 | ○ | ● | ○ | ○ | ○ | ○ | ○ | ○ | ○ | ○ | ○ | ○ | ○ | ○ | ○ |
| 500 | 1500 | 1190×840×110 | UID 1500K-1M | 1220,- | 125 | ○ | ● | ○ | ○ | ○ | ○ | ○ | ○ | ○ | ○ | ○ | ○ | ○ | ○ | ○ |
| 500 | 1500 | 1270×170×85 | UFA 1.5T0.5 | 1240,- | 123 | ● | ○ | ○ | ○ | ○ | ○ | ○ | ○ | ○ | ○ | ○ | ○ | ○ | ○ | ○ |
| 500 | 1500 | 1361×840×80 | UFC 1.5T-4M | 1270,- | 126 | ○ | ○ | ○ | ○ | ○ | ○ | ○ | ○ | ○ | ○ | ○ | ○ | ○ | ○ | ○ |
| 500 | 1500 | 1200×1000×108 | BID 1T-4EM | 1300,- | 118 | ○ | ● | ○ | ○ | ○ | ○ | ○ | ○ | ○ | ○ | ○ | ○ | ○ | ○ | ○ |
| 500 | 1500 | 1200×1500×108 | BID 1T-4M | 1600,- | 118 | ○ | ● | ○ | ○ | ○ | ○ | ○ | ○ | ○ | ○ | ○ | ○ | ○ | ○ | ○ |
| 500 | 1500 | 1600×1220×95 | NXC 1.5T-4M | 3940,- | 130 | ○ | ○ | ○ | ○ | ○ | ○ | ○ | ○ | ○ | ○ | ○ | ○ | ○ | ○ | ○ |
| 500 | 1500 | 1361×840×80 | UXC 1.5T-4M | 1890,- | 127 | ○ | ○ | ○ | ○ | ○ | ○ | ○ | ○ | ○ | ○ | ○ | ○ | ○ | ○ | ○ |
| 500 | 1500 | 1500×1500×108 | BID 1T-4LM | 1880,- | 118 | ○ | ● | ○ | ○ | ○ | ○ | ○ | ○ | ○ | ○ | ○ | ○ | ○ | ○ | ○ |
| 500 | 1500 | 1000×1000×85 | BFC 1.5T-4SM | 1420,- | 120 | ○ | ○ | ○ | ○ | ○ | ○ | ○ | ○ | ○ | ○ | ○ | ○ | ○ | ○ | ○ |
| 500 | 1500 | 1000×1000×85 | BXC 1.5T-4SM | 3020,- | 122 | ○ | ○ | ○ | ○ | ○ | ○ | ○ | ○ | ○ | ○ | ○ | ○ | ○ | ○ | ○ |
| 500 | 1500 | 1500×1250×85 | BFC 1.5T-4M | 1960,- | 120 | ○ | ○ | ○ | ○ | ○ | ○ | ○ | ○ | ○ | ○ | ○ | ○ | ○ | ○ | ○ |
| 500 | 1500 | 1500×1250×85 | BXC 1.5T-4M | 3840,- | 122 | ○ | ○ | ○ | ○ | ○ | ○ | ○ | ○ | ○ | ○ | ○ | ○ | ○ | ○ | ○ |
| 500 | 1500 | 1600×1220×95 | NFC 1.5T-4M | 1910,- | 129 | ○ | ○ | ○ | ○ | ○ | ○ | ○ | ○ | ○ | ○ | ○ | ○ | ○ | ○ | ○ |
| 500 | 1500 | 1800×1420×95 | NFC 1.5T-4LM | 2220,- | 129 | ○ | ○ | ○ | ○ | ○ | ○ | ○ | ○ | ○ | ○ | ○ | ○ | ○ | ○ | ○ |
| 500 | 1500 | 1195×840×110 | UIB 1.5T-4 | 990,- | 124 | | | | | | | | | | | | | | | |
| 1000 | 3000 | 1270×170×85 | UFA 3T1 | 1240,- | 123 | ● | ○ | ○ | ○ | ○ | ○ | ○ | ○ | ○ | ○ | ○ | ○ | ○ | ○ | ○ |
| 1000 | 3000 | 1195×840×110 | UID 3000K-OM | 1250,- | 125 | ○ | ● | ○ | ○ | ○ | ○ | ○ | ○ | ○ | ○ | ○ | ○ | ○ | ○ | ○ |
| 1000 | 3000 | 2000×120×90 | UFA 3T-3L | 1570,- | 123 | ● | ○ | ○ | ○ | ○ | ○ | ○ | ○ | ○ | ○ | ○ | ○ | ○ | ○ | ○ |
| 1000 | 3000 | 1200×1500×108 | BID 3T-3M | 1600,- | 118 | ○ | ● | ○ | ○ | ○ | ○ | ○ | ○ | ○ | ○ | ○ | ○ | ○ | ○ | ○ |
| 1000 | 3000 | 1500×1500×108 | BID 3T-3LM | 1880,- | 118 | ○ | ● | ○ | ○ | ○ | ○ | ○ | ○ | ○ | ○ | ○ | ○ | ○ | ○ | ○ |
| 1000 | 3000 | 1500×1250×85 | BFC 3T-3M | 1960,- | 120 | ○ | ○ | ○ | ○ | ○ | ○ | ○ | ○ | ○ | ○ | ○ | ○ | ○ | ○ | ○ |
| 1000 | 3000 | 1500×1250×85 | BXC 3T-3M | 3990,- | 122 | ○ | ○ | ○ | ○ | ○ | ○ | ○ | ○ | ○ | ○ | ○ | ○ | ○ | ○ | ○ |
| 1000 | 3000 | 1500×1500×85 | BFC 3T-3LM | 2200,- | 120 | ○ | ○ | ○ | ○ | ○ | ○ | ○ | ○ | ○ | ○ | ○ | ○ | ○ | ○ | ○ |
| 1000 | 3000 | 1195×840×110 | UIB 3T-3 | 990,- | 124 | | | | | | | | | | | | | | | |
| 2000 | 6000 | 1200×160×115 | UFA 6T-3 | 1610,- | 123 | ● | ○ | ○ | ○ | ○ | ○ | ○ | ○ | ○ | ○ | ○ | ○ | ○ | ○ | ○ |
| 2000 | 6000 | 1500×1500×123 | BFC 6T-3M | 2480,- | 120 | ○ | ○ | ○ | ○ | ○ | ○ | ○ | ○ | ○ | ○ | ○ | ○ | ○ | ○ | ○ |
| 2000 | 6000 | 2000×160×115 | UFA 6T-3L | 2120,- | 123 | ● | ○ | ○ | ○ | ○ | ○ | ○ | ○ | ○ | ○ | ○ | ○ | ○ | ○ | ○ |

● Standard ○ Option

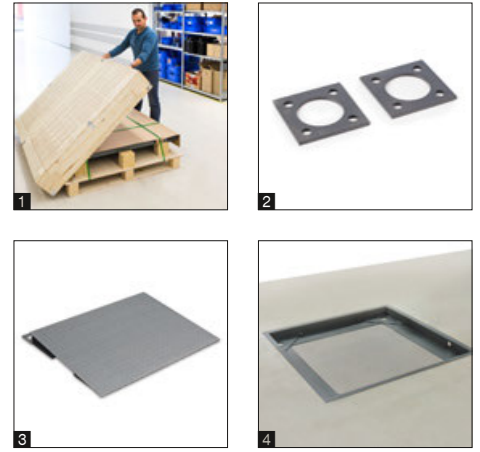
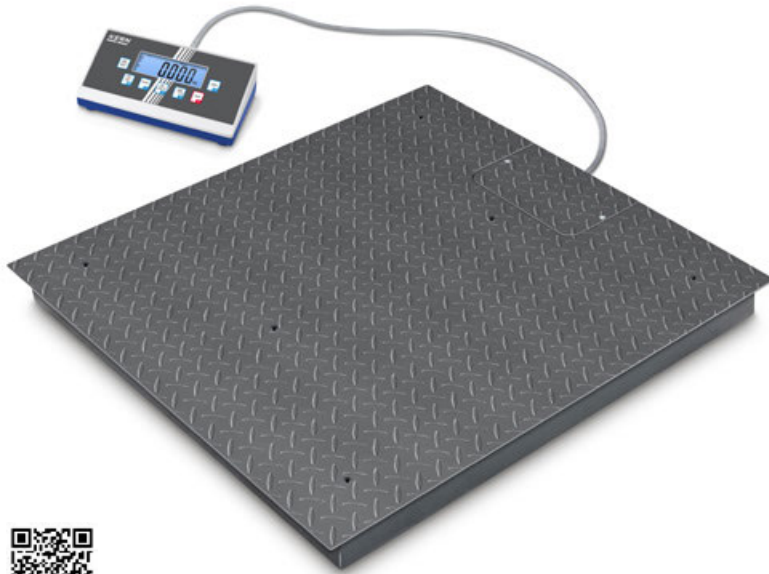

High-resolution floor scale with 2×3000 [d] and the best price-to-performance ratio

| Features | Technical data | Accessories |
|--|---|---|
| <ul style="list-style-type: none"> • Weighing bridge out of anti-slip corrugated steel, 4 load cells, alloy steel, silicone-coated, IP67 • Welded platform with screw holes to lift the scale for easy cleaning • Easy levelling of the weighing bridge as well as access to the junction box from above • Simple and convenient 4-key operation • Wall mount for display device, standard • 1 Our floor scales are delivered in a robust wooden box. This protects the high-quality weighing technology from environmental influences and stresses during transportation | <ul style="list-style-type: none"> • Large LCD display, digit height 25 mm • Weighing platform dimensions, steel, powder-coated <ul style="list-style-type: none"> A W×D×H 1000×1000×108 mm B W×D×H 1200×1500×108 mm C W×D×H 1500×1500×108 mm • Dimensions of display device W×D×H 235×114×51 mm • Optional battery operation, 4×1.5 V AA not included in scope of delivery, operating time up to 60 h • Cable length of display device approx. 5 m • Permissible ambient temperature -10 °C/40 °C | <ul style="list-style-type: none"> • Protective working cover over the display device, scope of delivery 5 items, KERN EOB-A04BS05, € 44,- • 2 Pair of base plates to fix the weighing bridge to the floor, KERN BIC-A07, € 44,- • 3 Ascending ramp, steel, powder-coated, for models with weighing plate size <ul style="list-style-type: none"> A 1000×1000×108 mm, KERN BIC-A01, € 425,- B 1200×1000×108 mm, KERN BIC-A02, € 530,- C 1500×1000×108 mm, KERN BIC-A03, € 600,- • 4 Stable pit frame, steel, powder-coated, for models with weighing plate size <ul style="list-style-type: none"> A 1088×1088×110 mm, KERN BIC-A04, € 350,- B 1288×1588×110 mm, KERN BIC-A05, € 460,- C 1588×1588×110 mm, KERN BIC-A06, € 490,- |

11

STANDARD

CAL EXT UNIT MOVE PT IP 67 LC IP 67 BATT MULTI DMS 2 DAYS

OPTION

DAkKS +3 DAYS

! Shipment via freight forwarder. Please ask for dimensions, gross weight, shipping costs

| Model | Weighing capacity [Max] kg | Readability [d] kg | Weighing plate | Net weight approx. kg | Price excl. of VAT ex works € | Options | |
|--------------------|----------------------------------|--------------------------|----------------|--------------------------|----------------------------------|---------|-------------------------------------|
| | | | | | | DAkKS | DAkKS Calibr. Certificate KERN € |
| BIC 600K-1S | 300 600 | 0,1 0,2 | A | 70 | 920,- | 963-130 | 215,- |
| BIC 600K-1 | 300 600 | 0,1 0,2 | B | 150 | 1340,- | 963-130 | 215,- |
| BIC 1T-4S | 600 1500 | 0,2 0,5 | A | 70 | 920,- | 963-130 | 215,- |
| BIC 1T-4 | 600 1500 | 0,2 0,5 | B | 150 | 1300,- | 963-130 | 215,- |
| BIC 3T-3 | 1500 3000 | 0,5 1 | B | 150 | 1300,- | 963-132 | 580,- |
| BIC 3T-3L | 1500 3000 | 0,5 1 | C | 155 | 1600,- | 963-132 | 580,- |

Multi-range balance, with increasing load it switches automatically to the next largest weighing range [Max] and readout [d] and when the load is fully removed, the balance switches back to the lower range

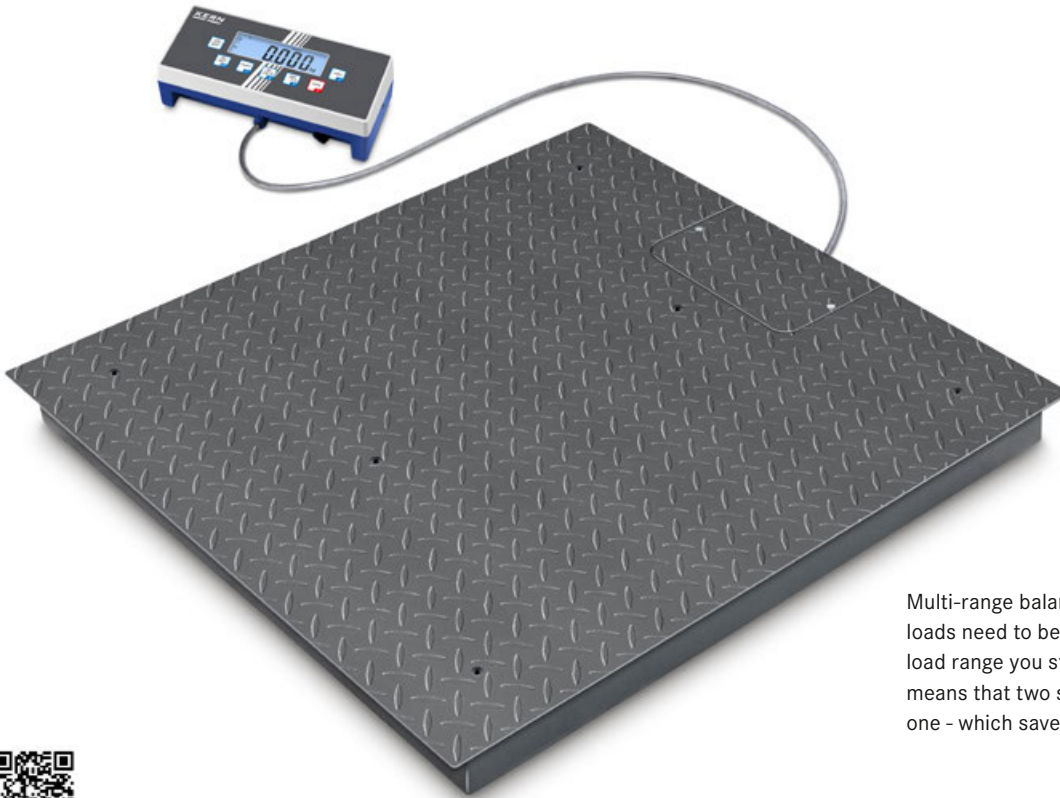

Multi-range balances, ideal, high maximum loads need to be weighed, but in the lower load range you still need high resolution. This means that two scales can be replaced with one - which saves space and money!



Multi-range floor scale with the best price-to-performance ratio, verification optional

11

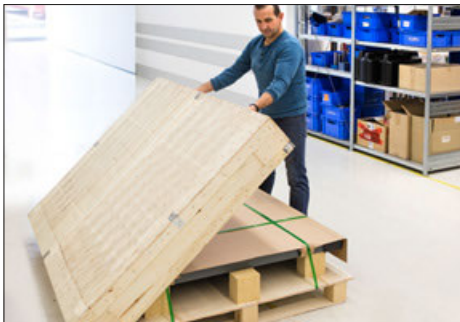

Our floor scales are delivered in a robust wooden box. This protects the high-quality weighing technology from environmental influences and stresses during transportation

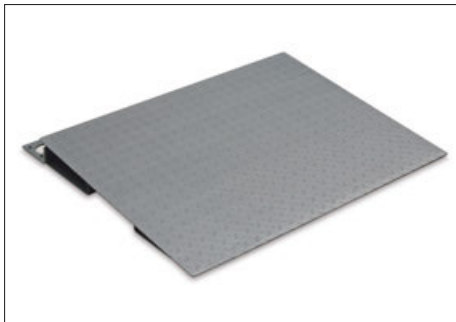

1 Access ramp incl. pair of base plates to facilitate access of e.g. wire cage trolleys, shelf trolleys, container trolleys, storage trolleys, sack trucks, transpallets, mobile containers, containers refuse etc.



2 Verification plug, for verified balances this enables you to separate the display device and platform without affecting the verification, e.g. for installing the scale in a packing and dispatch table, pit frame etc. at a later date. Please order this at the same time as you purchase your scale

3 In addition to the RS-232 data interface, which is integrated as standard, only one other data interface can be installed and operated

! Shipment via freight forwarder. Please ask for dimensions, gross weight, shipping costs

Features

- KERN BID 1T-4EM: Compact special size, especially for weighing europallets
- Display device: Plastic, protected against dust and water splashes IP65. for details see KERN KIB-TM
- Weighing bridge out of anti-slip corrugated steel, 4 load cells, alloy steel, silicone-coated, IP67
- Easy levelling of the weighing bridge as well as access to the junction box from above
- Totalising of weights and piece counts
- Thanks to interfaces such as RS-232 or USB, WiFi, Bluetooth, Ethernet (optional), the scale can easily be connected to existing networks. Data exchange between the scale, PC or printer
- KERN Communication Protocol (KCP): The KCP permits searching and remote control of the balance using external control devices or computers

Technical data

- Large LCD display, digit height 25 mm
- Weighing platform dimensions W×D×H, steel, powder-coated
 - A** 1000×1000×108 mm, **B** 1200×1000×108 mm
 - C** 1200×1500×108 mm, **D** 1500×1500×108 mm
- Dimensions of display device W×D×H 268×115×80 mm
- Cable length of display device approx. 5 m
- Permissible ambient temperature -10 °C/40 °C

Accessories

- Protective working cover, scope of delivery 5 items, KERN EOC-A01S05, **€ 55,-**
- Pair of base plates to fix the weighing bridge to the floor, KERN BIC-A07, **€ 44,-**
- **1** Ascending ramp, steel, powder-coated, for models with weighing plate size
 - A, B** 1000×1000×108 mm, KERN BIC-A01, **€ 425,-**
 - C** 1200×1000×108 mm, KERN BIC-A02, **€ 530,-**
 - D** 1500×1000×108 mm, KERN BIC-A03, **€ 600,-**
- Stable pit frame, Steel, powder-coated, to install the weighing bridge so you can drive straight on, for models with weighing plate size
 - A** 1088×1088×110 mm, KERN BIC-A04, **€ 350,-**
 - B** 1288×1088×110 mm, KERN BIC-A08, **€ 410,-**
 - C** 1288×1588×110 mm, KERN BIC-A05, **€ 460,-**
 - D** 1588×1588×110 mm, KERN BIC-A06, **€ 490,-**

- Benchtop stand incl. wall mount for display device, KERN EOC-A04, **€ 33,-**
- Internal rechargeable battery pack, operating time up to 43 h without backlight, charging time approx. 3 h, KERN KFB-A01, **€ 40,-**
- USB data interface, for transferring weighing to the PC, printer etc., must be ordered at purchase, KERN KIB-A03, **€ 120,-**
- Bluetooth data interface for wireless data transfer to PC or tablets, must be ordered at purchase, KERN KIB-A04, **€ 110,-**
- WiFi interface for wireless connection of the balance to networks and WiFi capable devices, such as tablets, laptops or smartphones, continuous data transfer, must be ordered at purchase, KERN KIB-A10, **€ 130,-**
- Ethernet data interface, to connect an IP-based Ethernet network, continuous data transfer, must be ordered at purchase, KERN KIB-A02, **€ 165,-**
- Signal lamp, including interface, for visual support of weighing with tolerance range, must be ordered at purchase, KERN KIB-A06, **€ 470,-**
- Alibi memory, for paperless archiving of the weighing results with ID no., gross/net/tare value, date and time, must be ordered at purchase, KERN KIB-A13, **€ 164,-**
- **2** Verification plug, for verified balances this enables you to separate the display device and platform without affecting the verification, e.g. for installing the scale in a packing and dispatch table, pit frame etc. at a later date. Please order this at the same time as you purchase your scale, KERN KIB-A12, **€ 164,-**

STANDARD

OPTION

FACTORY

| Model | Weighing capacity [Max] kg | Readability = Verification value [d] = [e] kg | Minimal load [Min] kg | Weighing plate | Net weight approx. kg | Price excl. of VAT ex works € | Options | | | |
|---|----------------------------|---|-----------------------|----------------|-----------------------|-------------------------------|--------------|-------|---------------|-------------|
| | | | | | | | Verification | € | DAkks Calibr. | Certificate |
| High-resolution versions with fine display | | | | | | | | | | |
| BID 600K-1DS | 300 600 | 0,05 0,1 | - | A | 75 | 1220,- | - | - | 963-130 | 215,- |
| BID 600K-1D | 300 600 | 0,05 0,1 | - | C | 150 | 1650,- | - | - | 963-130 | 215,- |
| BID 1T-4DS | 600 1500 | 0,1 0,2 | - | A | 75 | 1250,- | - | - | 963-130 | 215,- |
| BID 1T-4D | 600 1500 | 0,1 0,2 | - | C | 150 | 1650,- | - | - | 963-130 | 215,- |
| BID 3T-3D | 1500 3000 | 0,2 0,5 | - | C | 150 | 1650,- | - | - | 963-132 | 580,- |
| BID 3T-3DL | 1500 3000 | 0,2 0,5 | - | D | 155 | 1900,- | - | - | 963-132 | 580,- |
| Multi-range balance, with increasing load it switches automatically to the next largest weighing range [Max] and readout [d] and when the load is fully removed, the balance switches back to the lower range | | | | | | | | | | |
| BID 600K-1DSM | 300 600 | 0,1 0,2 | 2 4 | A | 75 | 1220,- | 965-230 | 158,- | 963-130 | 215,- |
| BID 600K-1DM | 300 600 | 0,1 0,2 | 2 4 | C | 150 | 1650,- | 965-230 | 158,- | 963-130 | 215,- |
| BID 1T-4DSM | 600 1500 | 0,2 0,5 | 4 10 | A | 75 | 1250,- | 965-230 | 158,- | 963-130 | 215,- |
| BID 1T-4DM | 600 1500 | 0,2 0,5 | 4 10 | C | 150 | 1650,- | 965-230 | 158,- | 963-130 | 215,- |
| BID 3T-3DM | 1500 3000 | 0,5 1 | 10 20 | C | 150 | 1650,- | 965-232 | 235,- | 963-132 | 580,- |
| BID 3T-3DLM | 1500 3000 | 0,5 1 | 10 20 | D | 155 | 1900,- | 965-232 | 235,- | 963-132 | 580,- |
| BID 600K-1SM | 600 | 0,2 | 4 | A | 75 | 1220,- | 965-230 | 158,- | 963-130 | 215,- |
| BID 600K-1M | 600 | 0,2 | 4 | C | 150 | 1600,- | 965-230 | 158,- | 963-130 | 215,- |
| BID 1T-4SM | 1500 | 0,5 | 10 | A | 70 | 1220,- | 965-230 | 158,- | 963-130 | 215,- |
| BID 1T-4EM | 1500 | 0,5 | 10 | B | 85 | 1300,- | 965-230 | 158,- | 963-130 | 215,- |
| BID 1T-4M | 1500 | 0,5 | 10 | C | 150 | 1600,- | 965-230 | 158,- | 963-130 | 215,- |
| BID 1T-4LM | 1500 | 0,5 | 10 | D | 155 | 1880,- | 965-230 | 158,- | 963-130 | 215,- |
| BID 3T-3M | 3000 | 1 | 20 | C | 150 | 1600,- | 965-232 | 235,- | 963-132 | 580,- |
| BID 3T-3LM | 3000 | 1 | 20 | D | 155 | 1880,- | 965-232 | 235,- | 963-132 | 580,- |

Note: For devices that require verification (conformity assessment according to NAWI 2014/31/EU), please include the verification when placing your order.

The initial verification is not possible after delivery. Please inform the full address of the location of use for the initial verification.

Note: For verified scales the weighing bridge must be fixed to the floor. Optionally, with an access ramp, a footplate pair or a pit frame

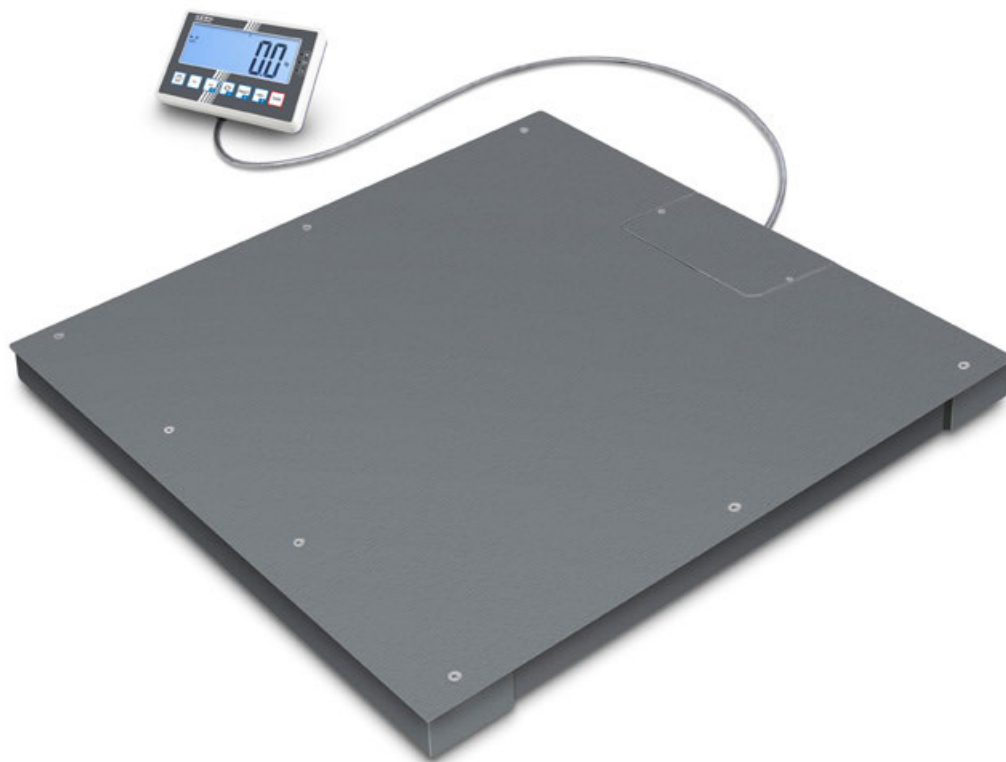

Floor Scale with screwed-on weighing plate (IP67), verification optional

11



1 Weighing plate can be unscrewed - The weighing plate can be conveniently unscrewed for maintenance or cleaning purposes (Exception: BFC 6T-3M)



Easy levelling of the weighing bridge as well as access to the junction box from above



2 Ascending ramp, lacquered steel, see *Accessories*

Features

- **1** Weighing plate: smooth surface, screwed on from the top, so it easy to remove, hygienic and easy to clean (Exception: KERN BFC 6T-3M)
- KERN BFC 6T-3M: Weighing plate welded, steel chequer plate
- 4 silicone-coated steel load cells, IP67 dust and spray protection
- Display device: for details see KERN KFC-TM
- IoT line: networkable balances with user-friendly concept of operation, for details see KERN KFC-TM
- With Real Time Clock as standard: Enables you to log the weighing results with accurate time information. Even if the power supply is interrupted, the balance can continue to work with the correct time
- Benchtop stand incl. wall mount for display device as standard
- Protective working cover included with delivery

Technical data

- Large backlit LCD display, digit height 48 mm
- Weighing platform dimensions W×D×H, steel, powder-coated
 - A** 1000×1000×85 mm
 - B** 1500×1250×85 mm
 - C** 1500×1500×85 mm
 - D** 1500×1500×123 mm
- Dimensions of display device W×D×H 220×145×65 mm
- Permissible ambient temperature -10 °C/40 °C



Accessories

- Protective working cover, scope of delivery 5 items, KERN YBA-A18S05, € 52,-
- **3** Stand to elevate display device, height of stand approx. 1040 mm, KERN BFS-A07, € 170,-
- Pair of base plates to fix the weighing bridge to the floor, for models with weighing plate size
 - A - C** KERN BFS-A06N, € 80,-
 - D** KERN BFS-A10, € 67,-
- **2** Ascending ramp, steel, lacquered, for models with weighing plate size
 - A** 1000×740×90 mm, KERN BFS-A01N, € 405,-
 - B** 1250×740×90 mm, KERN BFS-A02N, € 480,-
 - C** 1500×740×90 mm, KERN BFS-A09N, € 630,-
 - D** 1500×750×120 mm, KERN BFS-A11, € 680,-
- **4** Stable pit frame, steel, lacquered, for models with weighing plate size
 - A** 1090×1090×90 mm, KERN BFS-A03N, € 380,-
 - B** 1590×1340×90 mm, KERN BFS-A04N, € 450,-
 - C** 1590×1590×90 mm, KERN BFS-A08N, € 500,-
- Internal rechargeable battery pack, operating time up to 22 h without backlight, charging time approx. 8 h, KERN YKR-01, € 35,-



- RS-232 interface adapter, KERN KUP-01, € 60,-
- USB interface adapter, KERN KUP-03, € 75,-
- Ethernet interface adapter, KERN KUP-04, € 115,-
- WiFi interface adapter, KERN KUP-05, € 75,-
- Bluetooth interface adapter, KERN KUP-06, € 99,-
- Analogue module, KERN KUP-08, € 170,-
- Extension box for connecting up to three interfaces in parallel, KERN KUP-13, € 75,-
- Memory module (alibi memory), KERN YMM-04, € 80,-
- Signal lamp for visual support of weighing with tolerance range, KERN CFS-A03, € 310,-
- Further details, plenty of further accessories and suitable printers see *Accessories*

STANDARD



OPTION



FACTORY



! Shipment via freight forwarder. Please ask for dimensions, gross weight, shipping costs

| Model | Weighing capacity [Max] kg | Readability = Verification value [d] = [e] kg | Minimal load [Min] kg | Cable length of display device approx. m | Net weight approx. kg | Weighing plate | Price excl. of VAT ex works € | Options | | | |
|---------------------|----------------------------|---|-----------------------|--|-----------------------|----------------|-------------------------------|--------------|--------------|---------------|-------------|
| | | | | | | | | Verification | Verification | DAkKS Calibr. | Certificate |
| BFC 600K-1SM | 600 | 0,2 | 4 | 5 | 105 | A | 1420,- | 965-230 | 158,- | 963-130 | 215,- |
| BFC 600K-1M | 600 | 0,2 | 4 | 5 | 140 | B | 1960,- | 965-230 | 158,- | 963-130 | 215,- |
| BFC 1.5T-4SM | 1500 | 0,5 | 10 | 5 | 105 | A | 1420,- | 965-230 | 158,- | 963-130 | 215,- |
| BFC 1.5T-4M | 1500 | 0,5 | 10 | 5 | 140 | B | 1960,- | 965-230 | 158,- | 963-130 | 215,- |
| BFC 3T-3M | 3000 | 1 | 20 | 5 | 140 | B | 1960,- | 965-232 | 235,- | 963-132 | 580,- |
| BFC 3T-3LM | 3000 | 1 | 20 | 5 | 155 | C | 2200,- | 965-232 | 235,- | 963-132 | 580,- |
| BFC 6T-3M | 6000 | 2 | 40 | 5 | 230 | D | 2480,- | 965-232 | 235,- | 963-132 | 580,- |

Note: For devices that require verification (conformity assessment according to NAWI 2014/31/EU), please include the verification when placing your order.

The initial verification is not possible after delivery. Please inform the full address of the location of use for the initial verification.

Note: For verified scales the weighing bridge must be fixed to the floor. Optionally, with an access ramp, a footplate pair or a pit frame

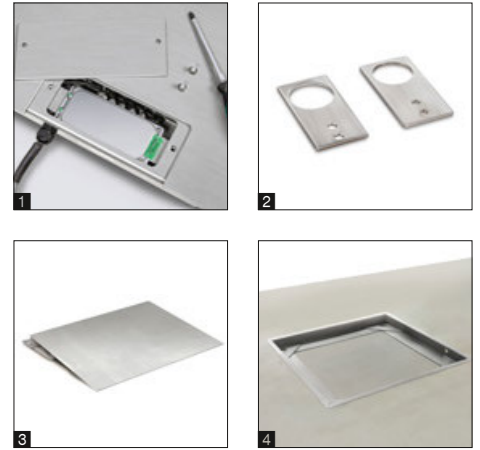
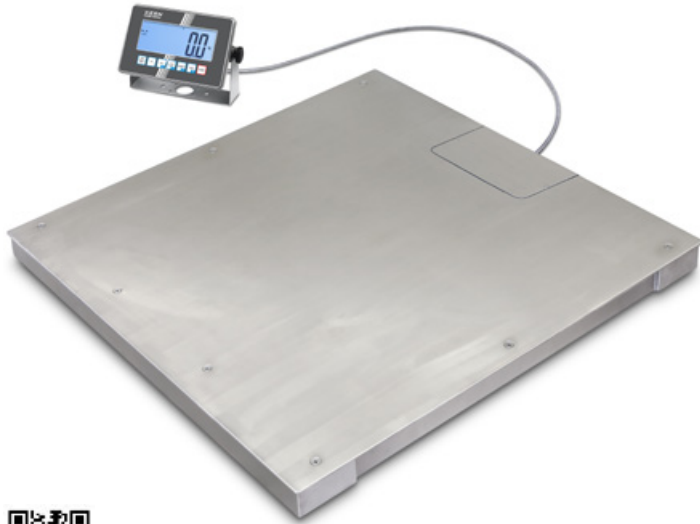

Floor scale with screwed-on weighing plate (IP67) and stainless steel display device (IP68), verification optional

Features

- Tough industry standard suitable for use in harsh industrial applications
- 1** Weighing plate screwed on from the top with stainless steel screws, so it's easy to remove, hygienic and easy to clean
- Weighing bridge: stainless steel, extremely resistant to bending due to material thickness, 4 hermetically welded stainless steel load cells, IP68 dust and spray protection
- Easy levelling of the weighing bridge as well as access to the junction box from above
- Display device: stainless steel, protection against dust and water splashes IP68, for details see KERN XXC-TM
- IoT line: networkable balances with user-friendly concept of operation
- The exchange of data and control commands is optional using up to four interfaces to suit

individual requirements: two wired connections and two wireless connections, for details see KERN XXC-TM

- Available as an option with alibi memory for paperless archiving of weighing results. This also means the results of weighings with mandatory verification can be electronically evaluated and processed further
- Wall mount for display device, standard

Technical data

- Large backlit LCD display, digit height 48 mm
- Weighing platform dimensions W×D×H, stainless steel
 - A** 1000×1000×85 mm
 - B** 1500×1250×85 mm
- Dimensions of display device W×D×H 232×150×80 mm
- Permissible ambient temperature -10 °C/40 °C

Accessories

- Stand to elevate display device, height of stand approx. 1040 mm, KERN BFS-A07, **€ 170,-**
- 2** Pair of base plates to fix the weighing bridge to the floor, KERN BFN-A03, **€ 95,-**
- 3** Ascending ramp, Stainless steel, for models with weighing plate size
 - A** 1000×740×90 mm, KERN BFN-A05, **€ 1350,-**
 - B** 1250×760×85 mm, KERN BFN-A01, **€ 1530,-**
- 4** Stable pit frame, Stainless steel, for models with weighing plate size
 - A** 1090×1090×90 mm, KERN BFN-A06, **€ 880,-**
 - B** 1590×1340×90 mm, KERN BFN-A02, **€ 1150,-**
- Internal rechargeable battery pack, operating time up to 22 h without backlight, charging time approx. 8 h, must be ordered at purchase, KERN YKR-01, **€ 35,-**
- Memory module with real time clock (alibi memory), KERN YMM-06, **€ 160,-**
- Internal data interface RS-232, interface cable included, KERN KUM-01, **€ 120,-**
- Internal data interface USB, interface cable included, KERN KUM-03, **€ 120,-**
- Internal data interface Ethernet, interface cable included, KERN KUM-04, **€ 165,-**
- Internal data interface WiFi, KERN KUM-05, **€ 95,-**
- Internal data interface Bluetooth, KERN KUM-06, **€ 135,-**
- Analogue module, KERN KUM-08, **€ 145,-**
- Further details, plenty of further accessories and suitable printers see *Accessories*

STANDARD



OPTION

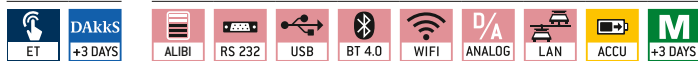

! Shipment via freight forwarder. Please ask for dimensions, gross weight, shipping costs

| Model | Weighing capacity [Max] kg | Readability = Verification value [d] = [e] kg | Minimal load [Min] kg | Cable length of display device approx. m | Net weight approx. kg | Weighing plate | Price excl. of VAT ex works € | Options | | | | |
|--------------------------|----------------------------|---|-----------------------|--|-----------------------|----------------|-------------------------------|---------------|---------|---------------------------|---------|-------|
| | | | | | | | | Verification | € | DAkkS Calibr. Certificate | € | |
| KERN BXC 600K-1SM | 600 | 0,2 | 4 | 5 | 85 | A | 3020,- | M KERN | 965-230 | 158,- | 963-130 | 215,- |
| BXC 1.5T-4SM | 1500 | 0,5 | 10 | 5 | 85 | A | 3020,- | M KERN | 965-230 | 158,- | 963-130 | 215,- |
| BXC 1.5T-4M | 1500 | 0,5 | 10 | 5 | 120 | B | 3840,- | M KERN | 965-230 | 158,- | 963-130 | 215,- |
| BXC 3T-3M | 3000 | 1 | 20 | 5 | 150 | B | 3990,- | M KERN | 965-232 | 235,- | 963-132 | 580,- |

Note: For devices that require verification (conformity assessment according to NAWI 2014/31/EU), please include the verification when placing your order. The initial verification is not possible after delivery. Please inform the full address of the location of use for the initial verification.

Note: For verified scales the weighing bridge must be fixed to the floor. Optionally, with an access ramp, a footplate pair or a pit frame



Highly versatile weighing beams (IP67) for large loads to 6 t

Features

- Flexible solution for weighing large, bulky or long items, thanks to freely positionable weighing beams and a 5 m (!) long connecting cable between the beams
- Thanks to rechargeable battery operation (optional), compact, lightweight construction, it is suitable for the use in several locations
- Weighing beams: steel, painted, 4 silicone-coated aluminium load cells, protection against dust and water splashes IP67
- **1** Sturdy handles for transporting the weighing beams
- **1** KERN UFA-L: Each weighing beam has a roller and handle for easy transport of the scale, see larger picture
- Display device: for details see KERN KFB-TM
- Benchtop stand incl. wall mount for display device as standard
- Totalising of weights and piece counts
- Protective working cover included with delivery

- KERN UFA-S: Model with short weighing beams, ideal for weighing compact items or animals in transport boxes
- Our floor scales are delivered in a robust wooden box. This protects the high-quality weighing technology from environmental influences and stresses during transportation

Technical data

- Large backlit LCD display, digit height 52 mm
- Dimensions of display device WxDxH 250x160x65 mm
- Cable length of display device approx. 5 m
- Connection cable approx. 5 m
- Permissible ambient temperature -10 °C/40 °C

Accessories

- Protective working cover over the display device, scope of delivery 5 items, KERN KFB-A02S05, **€ 52,-**
- **2** Stand to elevate display device, height of stand approx. 1040 mm, KERN BFS-A07, **€ 170,-**



- Internal rechargeable battery pack, operating time up to 35 h without backlight, charging time approx. 10 h, KERN KFB-A01, **€ 40,-**
- Bluetooth data interface for wireless data transfer to PC or tablets, must be ordered at purchase. When installing the Bluetooth data interface, the RS-232 data interface can no longer be used, KERN KFB-A03, **€ 160,-**
- Analogue module, must be ordered at purchase, not possible in combination with signal lamp or rechargeable battery pack
0-10 V: KERN KFB-A04, **€ 170,-**
4-20 mA: KERN KFB-A05, **€ 170,-**
- **3** Signal lamp for visual support of weighing with tolerance range, not possible in combination with analogue module, KERN CFS-A03, **€ 310,-**
- **4** Large display with superior display size KERN YKD-A02, **€ 310,-**
- Y-cable for parallel connection of two terminal devices to the RS-232 interface on the scale, e.g. signal lamp and printer, KERN CFS-A04, **€ 38,-**
- Cable with special length 15 m, between display device and platform, for verified models which must be ordered at the time of purchase, KERN BFB-A03, **€ 195,-**
- Further details, plenty of further accessories and suitable printers see *Accessories*

! Shipment via freight forwarder. Please ask for dimensions, gross weight, shipping costs

STANDARD



OPTION



FACTORY



| Model | Weighing capacity | Readability | Dimensions Weighing beam WxDxH mm | Net weight approx. | Price excl. of VAT ex works € | Options | |
|-------------|-------------------|-------------|-----------------------------------|--------------------|-------------------------------|---------|---------------------|
| | | | | | | DAkKS | Calibr. Certificate |
| KERN | [Max] kg | [d] kg | | kg | | KERN | € |
| UFA 600K-1S | 600 | 0,2 | 870x120x84 | 36 | 1140,- | 963-130 | 215,- |
| UFA 1.5T0.5 | 1500 | 0,5 | 1270x170x85 | 40 | 1240,- | 963-130 | 215,- |
| UFA 3T1 | 3000 | 1 | 1270x170x85 | 38 | 1240,- | 963-132 | 580,- |
| UFA 3T-3L | 3000 | 1 | 2000x120x90 | 60 | 1570,- | 963-132 | 580,- |
| UFA 6T-3 | 6000 | 2 | 1200x160x115 | 90 | 1610,- | 963-132 | 580,- |
| UFA 6T-3L | 6000 | 2 | 2000x160x115 | 130 | 2120,- | 963-132 | 580,- |

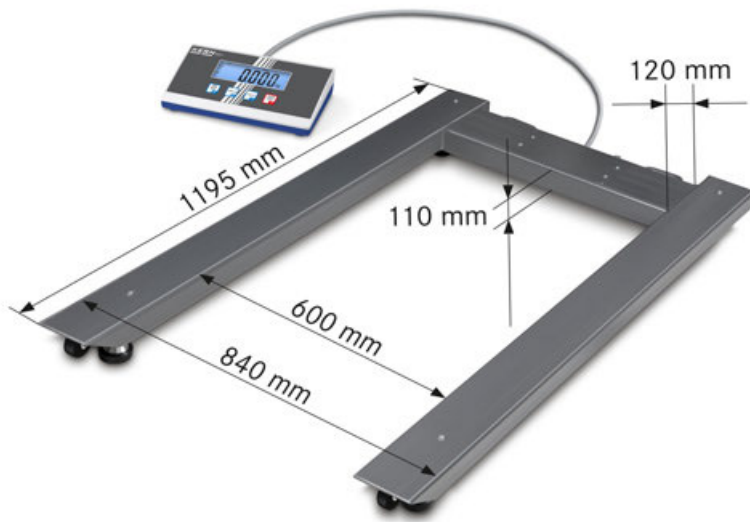

Pallet scale with steel load support (IP67) and the best price-to-performance ratio

Features

- Thanks to battery operation, compact, light-weight construction, it is suitable for the use in several locations
- Load support: steel, powder coated, 4 silicone-coated aluminium load cells, protection against dust and water splashes IP67
- **1** The scale can be easily transported using rollers and a handle and does not require much storage space
- Protective working cover included with delivery
- **2** Our floor scales are delivered in a robust wooden box. This protects the high-quality weighing technology from environmental influences and stresses during transportation

Technical data

- Large LCD display, digit height 25 mm
- Dimensions of display device W×D×H 235×114×51 mm
- Cable length of display device approx. 5 m
- Optional battery operation, 4×1.5 V AA not included in scope of delivery, operating time up to 60 h
- Net weight approx. 55 kg
- Permissible ambient temperature -10 °C/40 °C

Accessories

- Protective working cover over the display device, scope of delivery 5 items, KERN EOB-A04BS05, **€ 44,-**
- Stand to elevate display device, height of stand approx. 1000 mm, KERN EOB-A02B, **€ 112,-**

11

! Shipment via freight forwarder. Please ask for dimensions, gross weight, shipping costs

STANDARD



OPTION



| Model | Weighing capacity [Max] kg | Readability [d] kg | Price excl. of VAT ex works € | Options | |
|-------------------|----------------------------------|--------------------------|--|---------------|--------------------------------|
| | | | | DAkkS KERN | DAkkS Calibr. Certificate € |
| KERN | | | | | |
| UIB 600K-1 | 600 | 0,2 | 990,- | 963-130 | 215,- |
| UIB 1.5T-4 | 1500 | 0,5 | 990,- | 963-130 | 215,- |
| UIB 3T-3 | 3000 | 1 | 990,- | 963-132 | 580,- |



High-resolution multi-range pallet scale with a wide range of interfaces, verification optional

Features

- Ideal, when high maximum loads need to be weighed, but in the lower load range you still need high resolution. This means that two balances can be replaced with one
- High mobility thanks to rechargeable battery operation (optional)
- Display device: Protection against dust and water splashes IP65
- Load support: steel, powder coated, 4 load cells, alloy steel, silicone-coated, protection against dust and water splashes IP67
- The scale can be easily transported using rollers and a handle and does not require much storage space
- Totalising of weights and piece counts

- KERN Communication Protocol (KCP): The KCP permits searching and remote control of the balance using external control devices or computers
- Thanks to interfaces such as RS-232 or USB, WiFi, Bluetooth, Ethernet (optional), the scale can easily be connected to existing networks. Data exchange between the scale, PC or printer
- Protective working cover included with delivery

Technical data

- Large LCD display, digit height 25 mm
- Dimensions of display device WxDxH 268x115x80 mm
- Permissible ambient temperature -10 °C/40 °C

Accessories

- Protective working cover, scope of delivery 5 items, KERN EOC-A01S05, € 55,-
- Stand to elevate display device, height of stand approx. 1040 mm, KERN BFS-A07, € 170,-
- Internal rechargeable battery pack, operating time up to 43 h without backlight, charging time approx. 3 h, KERN KFB-A01, € 40,-
- USB data interface, for transferring weighing to the PC, printer etc., must be ordered at purchase, KERN KIB-A03, € 120,-
- Bluetooth data interface for wireless data transfer to PC or tablets, must be ordered at purchase, KERN KIB-A04, € 110,-
- WiFi interface for wireless connection of the balance to networks and WiFi capable devices, such as tablets, laptops or smartphones, continuous data transfer, must be ordered at purchase, KERN KIB-A10, € 130,-
- Ethernet data interface, to connect an IP-based Ethernet network, continuous data transfer, must be ordered at purchase, KERN KIB-A02, € 165,-
- Signal lamp, including interface, for visual support of weighing with tolerance range, must be ordered at purchase, KERN KIB-A06, € 470,-
- Alibi memory, including USB interface for exporting weighing results to external data storage media, such as, for example, USB sticks, hard drives, etc., must be ordered at purchase, KERN KIB-A01, € 175,-
- Verification plug, for verified balances this enables you to separate the display device and platform without affecting the verification, e.g. for installing the scale in a packing and dispatch table, pit frame etc. at a later date. Please order this at the same time as you purchase your scale, KERN KIB-A12, € 164,-

STANDARD



OPTION



FACTORY

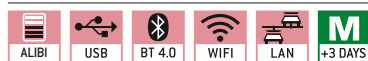

1 Only one optional interface can be installed and used
! Shipment via freight forwarder. Please ask for dimensions, gross weight, shipping costs

| Model | Weighing capacity [Max] kg | Readability = Verification value [d] = [e] kg | Minimal load [Min] kg | Cable length of display device approx. m | Net weight approx. kg | Price excl. of VAT ex works € | Options | | | |
|---|----------------------------------|--|--------------------------------|---|--------------------------------|--|---------------------------|------------|----------------------|------------------|
| | | | | | | | Verification KERN € | DAKkS € | Calibr. KERN € | Certificate € |
| UID 600K-1M | 600 | 0,2 | 4 | 5 | 44 | 1220,- | 965-230 | 158,- | 963-130 | 215,- |
| UID 1500K-1M | 1500 | 0,5 | 10 | 5 | 44 | 1220,- | 965-230 | 158,- | 963-130 | 215,- |
| UID 3000K-0M | 3000 | 1 | 20 | 5 | 44 | 1250,- | 965-232 | 235,- | 963-132 | 580,- |
| Multi-range balance, with increasing load it switches automatically to the next largest weighing range [Max] and readout [d] and when the load is fully removed, the balance switches back to the lower range | | | | | | | | | | |
| UID 600K-1DM | 300 600 | 0,1 0,2 | 2 4 | 5 | 44 | 1280,- | 965-230 | 158,- | 963-130 | 215,- |
| UID 1500K-1DM | 600 1500 | 0,2 0,5 | 4 10 | 5 | 44 | 1260,- | 965-230 | 158,- | 963-130 | 215,- |
| UID 3000K-0DM | 1500 3000 | 0,5 1 | 10 20 | 5 | 44 | 1260,- | 965-232 | 235,- | 963-132 | 580,- |

Note: For devices that require verification (conformity assessment according to NAWI 2014/31/EU), please include the verification when placing your order. The initial verification is not possible after delivery. Please inform the full address of the location of use for the initial verification.

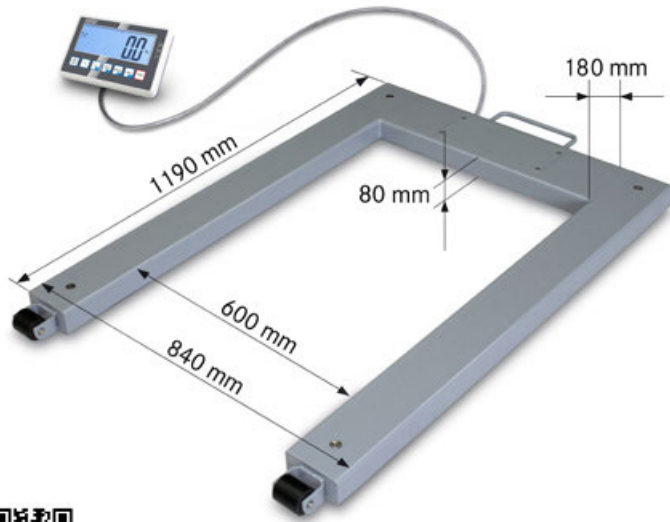

Pallet scale with steel load support (IP67), verification optional

Features

- Thanks to rechargeable battery operation (optional), compact, lightweight construction, it is suitable for the use in several locations
- Display device: for details see KERN KFC-TM
- IoT line: networkable balances with user-friendly concept of operation, for details see KERN KFC-TM
- With Real Time Clock as standard: Enables you to log the weighing results with accurate time information. Even if the power supply is interrupted, the balance can continue to work with the correct time

- Load support: steel, powder coated, 4 load cells, alloy steel, silicone-coated, protection against dust and water splashes IP67, Weighing bridge can also be delivered as component without the display device, for details see KERN KFU-V20
- Two wheels for easy transportation of the scale
- Weighing with tolerance range (checkweighing): A visual and audible signal assists the rapid checking of items on pallets
- Totalising of weights and piece counts
- Protective working cover included with delivery

Technical data

- Large backlit LCD display, digit height 48 mm
- Dimensions of display device W×D×H 220×145×65 mm
- Cable length of display device approx. 5 m
- Permissible ambient temperature -10 °C/40 °C

Accessories

- Protective working cover, scope of delivery 5 items, KERN YBA-A18S05, € 52,-
- 1 Stand to elevate display device, height of stand approx. 1040 mm, KERN BFS-A07, € 170,-
- Internal rechargeable battery pack, operating time up to 22 h without backlight, charging time approx. 8 h, KERN YKR-01, € 35,-
- RS-232 interface adapter, KERN KUP-01, € 60,-
- USB interface adapter, KERN KUP-03, € 75,-
- Ethernet interface adapter, KERN KUP-04, € 115,-
- WiFi interface adapter, KERN KUP-05, € 75,-
- Bluetooth interface adapter, KERN KUP-06, € 99,-
- Analogue module, KERN KUP-08, € 170,-
- Extension box for connecting up to three interfaces in parallel, KERN KUP-13, € 75,-
- Memory module (alibi memory), KERN YMM-04, € 80,-
- 2 Signal lamp for visual support of weighing with tolerance range, KERN CFS-A03, € 310,-
- Further details, plenty of further accessories and suitable printers see *Accessories*

STANDARD



OPTION



FACTORY



! Shipment via freight forwarder. Please ask for dimensions, gross weight, shipping costs

| Model | Weighing capacity [Max] kg | Readability = Verification value [d] = [e] kg | Minimal load [Min] kg | Net weight approx. kg | Price excl. of VAT ex works € | Options | | | |
|--------------------|----------------------------|---|-----------------------|-----------------------|-------------------------------|--------------|-------|---------------------------|-------|
| | | | | | | Verification | | DAkkS Calibr. Certificate | |
| | | | | | | M | | DAkkS | |
| | | | | | | KERN | € | KERN | € |
| UFC 600K-1M | 600 | 0,2 | 4 | 55 | 1250,- | 965-230 | 158,- | 963-130 | 215,- |
| UFC 1.5T-4M | 1500 | 0,5 | 10 | 55 | 1270,- | 965-230 | 158,- | 963-130 | 215,- |

Note: For devices that require verification (conformity assessment according to NAWI 2014/31/EU), please include the verification when placing your order. The initial verification is not possible after delivery. Please inform the full address of the location of use for the initial verification.

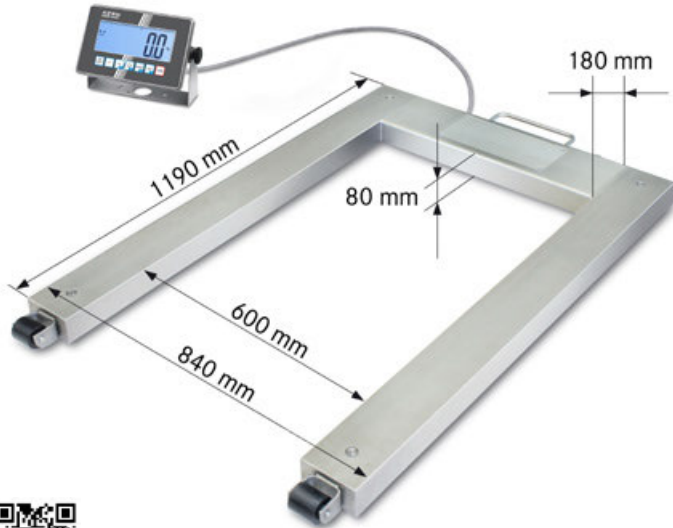

Pallet scale with stainless steel load support (IP67) and stainless steel display device (IP68), verification optional

Features

- Thanks to rechargeable battery operation, compact, lightweight construction, it is suitable for the use in several locations
- Load support: stainless steel, for details see KERN KFV-V30
- 4 silicone-coated steel load cells, IP67 dust and spray protection
- Ideal for the increased hygienic requirements in the food industries
- Your support in a HACCP-compliant quality system
- Display device: stainless steel, protection against dust and water splashes IP68, for details see KERN XXC-TM
- IoT line: networkable balances with user-friendly concept of operation
- The exchange of data and control commands is optional using up to four interfaces to suit individual requirements: two wired connections and two wireless connections, for details see KERN KXC-TM

- Available as an option with alibi memory for paperless archiving of weighing results. This also means the results of weighings with mandatory verification can be electronically evaluated and processed further
- Wall mount for display device, standard
- The scale can be easily transported using rollers and a handle and does not require much storage space
- Hold function: When the weighing conditions are unstable, a stable weight is calculated determining an average value
- Weighing with tolerance range (checkweighing): a visual and audible signal helps with portioning, dispensing or grading
- Summation of weight values

Technical data

- Large backlit LCD display, digit height 48 mm
- Dimensions of display device W×D×H 232×150×80 mm
- Permissible ambient temperature -10 °C/40 °C

Accessories

- **1** Stand to elevate display device, height of stand approx. 1040 mm, KERN BFS-A07, **€ 170,-**
- Internal rechargeable battery pack, operating time up to 22 h without backlight, charging time approx. 8 h, KERN YKR-01, **€ 35,-**
- Memory module with real time clock (alibi memory), KERN YMM-06, **€ 160,-**
- Internal data interface RS-232, interface cable included, KERN KUM-01, **€ 120,-**
- Internal data interface USB, interface cable included, KERN KUM-03, **€ 120,-**
- Internal data interface Ethernet, interface cable included, KERN KUM-04, **€ 165,-**
- Internal data interface WiFi, KERN KUM-05, **€ 95,-**
- Internal data interface Bluetooth, KERN KUM-06, **€ 135,-**
- Analogue module, KERN KUM-08, **€ 145,-**
- Further details, plenty of further accessories and suitable printers see *Accessories*

STANDARD

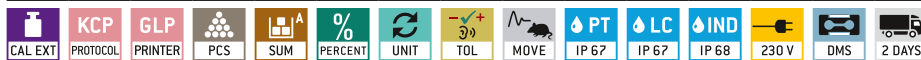

OPTION FACTORY

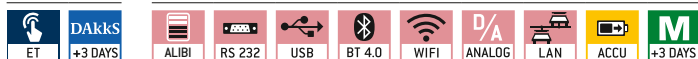

| Model | Weighing capacity [Max] kg | Readability = Verification value [d] = [e] kg | Minimal load [Min] kg | Cable length of display device approx. m | Net weight approx. kg | Price excl. of VAT ex works € | Options | | | |
|-------------------------|----------------------------|---|-----------------------|--|-----------------------|-------------------------------|--------------|-------|---------------------------|-------|
| | | | | | | | Verification | | DAkkS Calibr. Certificate | |
| KERN UXC 600K-1M | 600 | 0,2 | 4 | 5 | 55 | 1870,- | 965-230 | 158,- | 963-130 | 215,- |
| KERN UXC 1.5T-4M | 1500 | 0,5 | 10 | 5 | 50 | 1890,- | 965-230 | 158,- | 963-130 | 215,- |

Note: For devices that require verification (conformity assessment according to NAWI 2014/31/EU), please include the verification when placing your order. The initial verification is not possible after delivery. Please inform the full address of the location of use for the initial verification.

! Shipment via freight forwarder. Please ask for dimensions, gross weight, shipping costs



Compact, robust drive-through scale – particularly mobile thanks to its carrying handle, rollers and lightweight construction

Features

- Drive-through scales enable accurate weighing of goods during a production process, without having to unload them. In this way the weighing process can be perfectly integrated into the workflow and there is no significant loss of time. Ideal for rapid weighing of e.g. wire cage trolleys, shelf trolleys, container trolleys, storage trolleys, sack trucks, transpallets, mobile containers, containers refuse etc.
- Low platform height and integrated access ramps on both sides facilitate access
- Weighing bridge: Steel, powder coated, 4 silicon-coated aluminium load cells with protection against dust and water splashes to IP67
- **1** Level indicator to level the balance precisely
- **2** The scale can be easily transported using rollers and a handle and does not require much storage space
- Wall mount for the display device, as standard, only for models without a stand
- Protective working cover included with delivery
- **3** Our floor scales are delivered in a robust wooden box. This protects the high-quality weighing technology from environmental influences and stresses during transportation

Technical data

- Large LCD display, digit height 25 mm
- Platform height in the drive-through area: 40 mm
- Dimensions weighing surface, steel, lacquered WxD 800x800 mm (Without ramps)
- Overall dimensions WxDxH 1000x1000x80 mm
- Dimensions of display device WxDxH 235x114x51 mm
- Cable length of display device approx. 5 m
- Optional battery operation, 4x1.5 V AA not included in scope of delivery, operating time up to 60 h
- Permissible ambient temperature -10 °C/40 °C

Accessories

- Protective working cover over the display device, scope of delivery 5 items, KERN EOB-A04BS05, **€ 44,-**
- Pair of base plates to fix the weighing bridge to the floor, KERN BIC-A07, **€ 44,-**

11

STANDARD



OPTION



| Model | Weighing capacity [Max] kg | Readability [d] kg | Net weight approx. kg | Price excl. of VAT ex works € | Options | |
|-------------------|----------------------------------|--------------------------|-----------------------------|--|---------------|--------------------------------|
| | | | | | DAkKS KERN | DAkKS Calibr. Certificate € |
| KERN | | | | | | |
| NIB 300K-1 | 300 | 0,1 | 40 | 870,- | 963-129 | 153,- |
| NIB 600K-2 | 600 | 0,2 | 40 | 870,- | 963-130 | 215,- |



Networkable drive-through scale (IP67), verification optional

Features

- Drive-through scale for rapid weighing of e.g. wire cage trolleys, shelf trolleys, transpallets, mobile containers, containers refuse etc.
- Weighing bridge: out of anti-slip corrugated steel, 4 silicone-coated steel load cells, IP67 dust and spray protection
- Display device: for details see KERN KFC-TM
- IoT line: networkable balances with user-friendly concept of operation, for details see KERN KFC-TM
- With Real Time Clock as standard: Enables you to log the weighing results with accurate time information. Even if the power supply is interrupted, the balance can continue to work with the correct time
- Protective working cover included with delivery

Technical data

- Large backlit LCD display, digit height 48 mm
- Dimensions weighing surface, steel, powder-coated
 - A** W×D 1000×1000 mm (Without ramps)
 - B** W×D 1200×1200 mm (Without ramps)
- Overall dimensions W×D×H
 - A** 1600×1220×95 mm
 - B** 1800×1420×95 mm
- Platform height in the drive-through area: 80 mm
- Dimensions of display device W×D×H 220×145×65 mm
- Cable length of display device approx. 5 m
- Permissible ambient temperature -10 °C/40 °C

Accessories

- Protective working cover, scope of delivery 5 items, KERN YBA-A18S05, **€ 52,-**
- Stand to elevate display device, height of stand approx. 1040 mm, KERN BFS-A07, **€ 170,-**
- Internal rechargeable battery pack, operating time up to 22 h without backlight, charging time approx. 8 h, KERN YKR-01, **€ 35,-**
- Pair of base plates to fix the weighing bridge to the floor, KERN BFS-A06N, **€ 80,-**
- RS-232 interface adapter, KERN KUP-01, **€ 60,-**
- USB interface adapter, KERN KUP-03, **€ 75,-**
- Ethernet interface adapter, KERN KUP-04, **€ 115,-**
- WiFi interface adapter, KERN KUP-05, **€ 75,-**
- Bluetooth interface adapter, KERN KUP-06, **€ 99,-**
- Analogue module, KERN KUP-08, **€ 170,-**
- Extension box for connecting up to three interfaces in parallel, KERN KUP-13, **€ 75,-**
- Memory module (alibi memory), KERN YMM-04, **€ 80,-**
- **1** Signal lamp for visual support of weighing with tolerance range, KERN CFS-A03, **€ 310,-**
- Further details, plenty of further accessories and suitable printers see *Accessories*

STANDARD



OPTION



FACTORY



! Shipment via freight forwarder. Please ask for dimensions, gross weight, shipping costs

| Model | Weighing capacity [Max] kg | Readability = Verification value [d] = [e] kg | Minimal load [Min] kg | Net weight approx. m | Weighing plate | Price excl. of VAT ex works € | Options | | | | |
|--------------|----------------------------|---|-----------------------|----------------------|----------------|-------------------------------|--------------|---------|---------------------------|---------|-------|
| | | | | | | | Verification | € | DAkkS Calibr. Certificate | € | |
| KERN | | | | | | | M | | | | |
| NFC 600K-1M | 600 | 0,2 | 4 | 140 | A | 1910,- | KERN | 965-230 | 158,- | 963-130 | 215,- |
| NFC 600K-1LM | 600 | 0,2 | 4 | 165 | B | 2220,- | KERN | 965-230 | 158,- | 963-130 | 215,- |
| NFC 1.5T-4M | 1500 | 0,5 | 10 | 140 | A | 1910,- | KERN | 965-230 | 158,- | 963-130 | 215,- |
| NFC 1.5T-4LM | 1500 | 0,5 | 10 | 155 | B | 2220,- | KERN | 965-230 | 158,- | 963-130 | 215,- |

Note: For devices that require verification (conformity assessment according to NAWI 2014/31/EU), please include the verification when placing your order. The initial verification is not possible after delivery. Please inform the full address of the location of use for the initial verification.

Note: For verified scales the weighing bridge must be fixed to the floor. Optionally, with an access ramp, a footplate pair or a pit frame

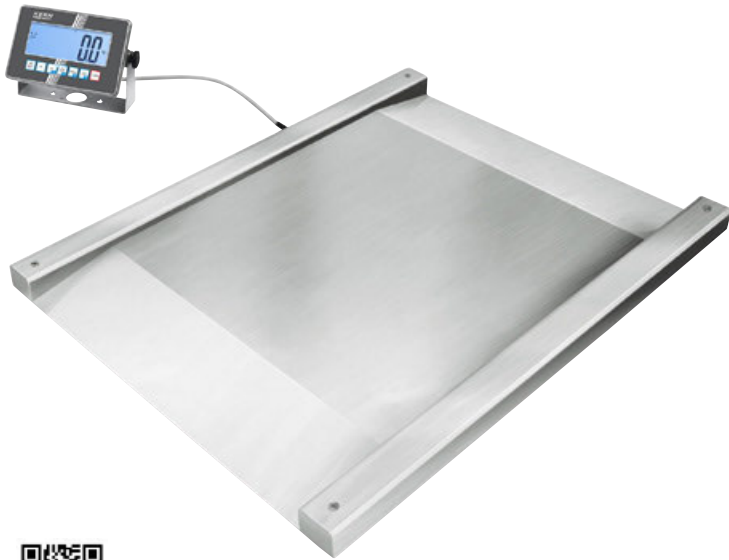

Stainless steel drive-through scale (IP67) with stainless steel display device (IP68), verification optional

Features

- Robust stainless steel drive-through scale for rapid weighing of e.g. laundry carts, container trolleys, roller containers, etc.
- Ideal for the ever-increasing hygienic requirements in the food, pharmaceutical and chemical industries
- Your support in a HACCP-compliant quality system
- Weighing bridge: stainless steel, extremely resistant to bending due to material thickness, 4 welded stainless steel load cells, IP68 dust and spray protection
- Display device: stainless steel, protection against dust and water splashes IP68, for details see KERN KXC-TM
- IoT line: networkable balances with user-friendly concept of operation
- The exchange of data and control commands is optional using up to four interfaces to suit

individual requirements: two wired connections and two wireless connections, for details see KERN KXC-TM

- Available as an option with alibi memory for paperless archiving of weighing results. This also means the results of weighings with mandatory verification can be electronically evaluated and processed further
- Wall mount for display device, standard

Technical data

- Large backlit LCD display, digit height 48 mm
- Dimensions weighing surface, stainless steel, WxD 1000x1000 mm (Without ramps)
- Platform height in the drive-through area: 80 mm
- Overall dimensions WxDxH 1600x1220x95 mm
- Dimensions of display device WxDxH 232x150x80 mm
- Permissible ambient temperature -10 °C/40 °C

Accessories

- ■ Stand to elevate display device, height of stand approx. 1040 mm, KERN BFS-A07, € 170,-
- Pair of base plates to fix the weighing bridge to the floor, KERN BFN-A03, € 95,-
- Internal rechargeable battery pack, operating time up to 22 h without backlight, charging time approx. 8 h, must be ordered at purchase, KERN YKR-01, € 35,-
- Memory module with real time clock (alibi memory), KERN YMM-06, € 160,-
- Internal data interface RS-232, interface cable included, KERN KUM-01, € 120,-
- Internal data interface USB, interface cable included, KERN KUM-03, € 120,-
- Internal data interface Ethernet, interface cable included, KERN KUM-04, € 165,-
- Internal data interface WiFi, KERN KUM-05, € 95,-
- Internal data interface Bluetooth, KERN KUM-06, € 135,-
- Analogue module, KERN KUM-08, € 145,-
- Further details, plenty of further accessories and suitable printers see *Accessories*

STANDARD

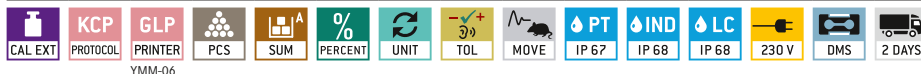

OPTION FACTORY

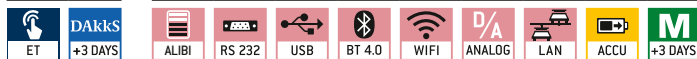

! Shipment via freight forwarder. Please ask for dimensions, gross weight, shipping costs

| Model | Weighing capacity [Max] kg | Readability = Verification value [d] = [e] kg | Minimal load [Min] kg | Cable length of display device approx. m | Net weight approx. kg | Price excl. of VAT ex works € | Options | | | | |
|-------------|----------------------------|---|-----------------------|--|-----------------------|-------------------------------|--------------|-------|---------------------------|-------|--|
| | | | | | | | Verification | | DAKkS Calibr. Certificate | | |
| KERN | | | | | | | M | | | | |
| NXC 600K-1M | 600 | 0,2 | 4 | 5 | 105 | 3890,- | 965-230 | 158,- | 963-130 | 215,- | |
| NXC 1.5T-4M | 1500 | 0,5 | 10 | 5 | 105 | 3940,- | 965-230 | 158,- | 963-130 | 215,- | |

Note: For devices that require verification (conformity assessment according to NAWI 2014/31/EU), please include the verification when placing your order. The initial verification is not possible after delivery. Please inform the full address of the location of use for the initial verification.

Note: For verified scales the weighing bridge must be fixed to the floor. Optionally, with an access ramp, a footplate pair or a pit frame

12



SYSTEM SOLUTIONS INDUSTRY 4.0, EASYTOUCH

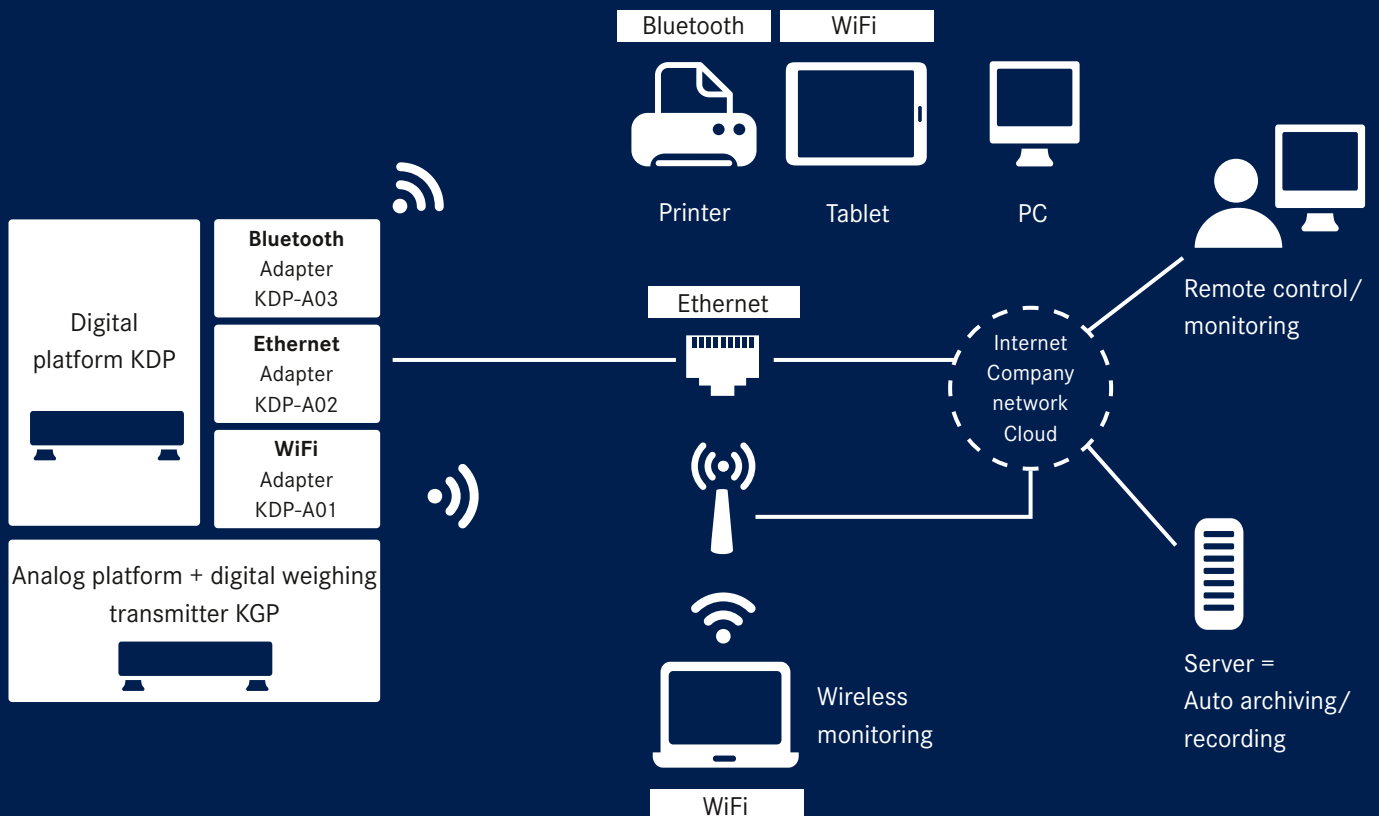

We will help to combine industrial production with the latest information and communication technology, with the aim of improving quality, reducing costs and using time and resources more efficiently so that you are able to react to future requirements in a more flexible manner. You will benefit from our uniform data protocol combined with our BalanceConnection 4.0 data software, *see Software*.

The KERN team in our centre of expertise – Industry 4.0



Daniel Egeler



Maximilian Pfister



Ralf Schmiege

We are happy to inform and advise you
Tel. +49 7433 9933-324, etsales@kern-sohn.com

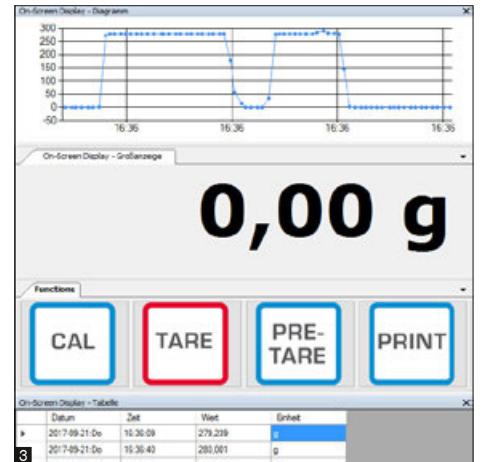

Robust industrial platform scale with digital weighing transmitter, ideal for varied range of applications for Industry 4.0

Features

- With this combination of platform **1** (KERN KFP V20 IP65) and digital weighing transmitter (KERN YKV-01) your weighing processes are ready for the requirements of Industry 4.0. Simply install the platform, connect the digital weighing transmitter to the network and start weighing
- For rapid transfer of weighing data to connected networks, computers, etc.
- USB and RS-232 data interface standard, power supply via USB interface
- Transfer formats are freely configurable
- Digital weighing transmitter with standard ethernet data interface on request

- Functions: Weighing, taring
- Internal resolution 16 million divisions
- Measuring frequency 10 Hz
- Easy configuration using the software supplied
- KERN YKV-01: Robust plastic die-cast housing
- **2** KERN YKV-01: Suitable for wall mounting and DIN track mount (optional)
- included with the delivery:
 - Industrial platform KERN KFP
 - Digital weighing transmitter KERN YKV-01
 - **2** DIN rail mounting bracket for KERN YKV
 - Configuration software for adjusting and managing the KERN KGP, enables the display and transfer of values, for example to a PC as well as conversion for different user programs such as SAP, Oracle etc.

Technical data

- Weighing plate material: stainless steel
- KERN YKV-01: Overall dimensions W×D×H 100×140×36 mm
- Permissible ambient temperature -10 °C/40 °C

Accessories

- Bluetooth data interface, KERN YKV-A02, € 98,-
- WiFi interface, KERN YKV-A01, € 98,-
- Ethernet data interface on request
- **3** BalanceConnection software for flexible measured value recording or transmission, compatible with Microsoft® Excel, Access and other applications, Scope of supplies: Download link for 1 license, KERN SCD-4.0-DL, € 210,-

STANDARD

- CAL EXT
- RS 232
- USB
- KCP PROTOCOL
- UNIT
- IP 65
- DMS
- 2 DAYS

OPTION

- ET
- DAkKS +3 DAYS

FACTORY

- BT 4.0
- WIFI
- LAN

| Model | Weighing capacity [Max] kg | Readability [d] g | Weighing platform W×D×H mm | Cable length approx. m | Net weight approx. kg | Price excl. of VAT ex works € | Options | |
|------------------|----------------------------|-------------------|----------------------------|------------------------|-----------------------|-------------------------------|--------------------|---------------|
| | | | | | | | DAkKS Calibr. KERN | Certificate € |
| KERN KGP 6K-4 | 6 | 0,2 | 230×230×106 | 3 | 6 | 440,- | 963-128 | 124,- |
| KERN KGP 6K-4L | 6 | 0,2 | 300×240×109 | 3 | 10 | 460,- | 963-128 | 124,- |
| KERN KGP 10K-4 | 15 | 0,5 | 300×240×109 | 3 | 6 | 480,- | 963-128 | 124,- |
| KERN KGP 10K-4L | 15 | 0,5 | 400×300×117 | 3 | 10 | 500,- | 963-128 | 124,- |
| KERN KGP 30K-3 | 30 | 1 | 300×240×109 | 3 | 6 | 460,- | 963-128 | 124,- |
| KERN KGP 30K-3L | 30 | 1 | 400×300×117 | 3 | 10 | 520,- | 963-128 | 124,- |
| KERN KGP 60K-3 | 60 | 2 | 400×300×117 | 3 | 10 | 540,- | 963-129 | 153,- |
| KERN KGP 60K-3L | 60 | 2 | 500×400×127 | 3 | 14 | 600,- | 963-129 | 153,- |
| KERN KGP 100K-3 | 150 | 5 | 500×400×127 | 3 | 14 | 600,- | 963-129 | 153,- |
| KERN KGP 100K-3L | 150 | 5 | 650×500×139 | 3 | 22 | 820,- | 963-129 | 153,- |
| KERN KGP 300K-2L | 300 | 10 | 650×500×139 | 3 | 22 | 870,- | 963-129 | 153,- |

1 ONLY WHILE STOCKS LAST

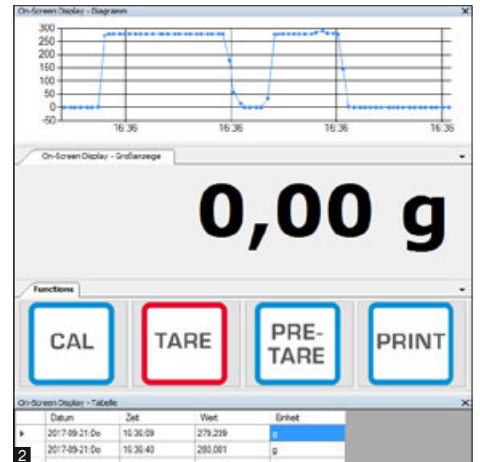
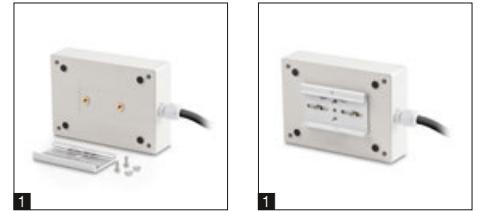

Modern digital weighing transmitter for the rapid recording of weighing data and forwarding it to the most varied output channels such as tablets, networks, SPS controllers, etc. – ideal for operating balances in systems or conveyors

Features Technical data Accessories

- Simply connect a weighing platform or measuring cell, integrate the digital weighing transmitter into the network and start weighing
- For rapid transfer of weighing data to connected networks, computers, etc.
- USB and RS-232 data interface standard, power supply via USB interface
- Transfer formats are freely configurable
- Functions: Weighing, taring
- Measuring frequency 10 Hz
- Easy configuration using the software supplied
- Robust plastic die-cast housing
- Suitable for wall mounting and DIN track mount
- Compatible with all KERN weighing platforms
- included with the delivery:
 - Digital weighing transmitter KERN YKV
 - USB cable incl. mains plug
 - DIN rail mounting bracket
 - Configuration software for adjusting and managing, enables the display and transfer of values, for example to a PC as well as conversion for different user programs such as SAP, Oracle etc.

- Overall dimensions WxDxH 100x140x36 mm
- Net weight approx. 0,35 kg
- Permissible ambient temperature -10 °C/40 °C

- Bluetooth data interface, KERN YKV-A02, € 98,-
- WiFi interface, KERN YKV-A01, € 98,-
- BalanceConnection software for flexible measured value recording or transmission, compatible with Microsoft® Excel, Access and other applications, Scope of supplies: Download link for 1 license, KERN SCD-4.0-DL, € 210,-

| | | | | | | | | | | | |
|----------|----------|-------|-------|--------|-----|-----|-----|------|--------|---------|--|
| STANDARD | | | | | | | | | | FACTORY | |
| | | | | | | | | | | | |
| CAL EXT | PROTOCOL | MULTI | 1 DAY | RS 232 | USB | LAN | GLP | UNIT | BT 4.0 | WIFI | |

YKV-02

| Model | Standard interfaces | Price excl. of VAT ex works € |
|-------------|-----------------------|-------------------------------|
| KERN YKV-01 | RS-232, USB | 265,- |
| KERN YKV-02 | RS-232, USB, Ethernet | 320,- |



Compact display device (rail-mounted module) for installation in switch cabinets

Features

- Compact display unit for recording weighing data using strain gauge load cells
- It is particularly space-saving to install in switch cabinets
- Thanks to the many interface variants, the modules can be ideally integrated into existing infrastructures and systems
- The modules can be used either individually or as a Buslink system with a total of up to 332 DIN rail modules
- Configuration of the module conveniently via a connected PC with the suitable software (Download see Internet)
- Bright LED display for optical control and settings
- Time-saving G-Cal™ (Geographic Calibration) technology for fast and accurate calibration without weights conveniently over a network or the Internet worldwide
- Convenient communication via remote devices
- Backup and restore function via USB port

- Can handle various industrial protocols such as Ethernet IP, Modbus TCP, Modbus RTU, FINS, PROFIBUS DP and PROFINET (according to model)
- Extremely high measurement frequency possible, up to 1600 data records/second
- Internal resolution 24 Bit

Technical data

- 7 segment LED display, digit height 7,62 mm
- Dimensions W×D×H 120×101×23 mm
- Power supply 18-32 Vdc; 4 W max.
- Power supply load cell 5 Vdc
- Sensitivity 0,1 µV/d
- Adjustable nominal sensitivity 1; 1.5; 2; 2.5; 3 mV/V
- Input voltage unipolar @ 3 mV/V: -1 mV to + 16 mV
- Input voltage bipolar @ 3 mV/V: -16 mV to +16 mV
- Max. load cell impedance 1200 Ω
- Min. load cell impedance 43,75 Ω
- Max. no. of load cells 350 Ω: 8
- Max. no. of load cells 1000 Ω: 22
- Max. resolution d 10.000
- Display steps 1, 2, 5, 10, 20, 50, 100, 200
- Permissible ambient temperature -10 °C/40 °C

Accessories

- Mains adapter for voltage supply to the KERN CE, can be fitted on the DIN rail, KERN CE HSS, € 90,-
- Large display with superior display size, KERN YKD-A02, € 310,-
- For further accessories, such as load and load cells, torque sensors and weighing platforms (strain gauge based only) from the SAUTER and KERN range, see internet
- Further accessories such as DIN rail, housing as well as individual assembly, configuration, adjustment, etc. on request

Note: Models optionally also available verified, please enquire

STANDARD



OPTION

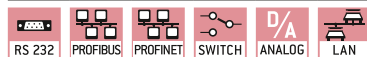

| Model | Communication Interfaces | Digital I/O | Analog output | Price excl. of VAT ex works € |
|-------------|--------------------------|--------------------|---------------|-------------------------------|
| KERN | | | | |
| CE HSAIO* | USB | 3 input / 4 output | 0/4-20/24 mA | 920,- |
| CE HSP* | USB, PROFIBUS | 3 input / 4 output | | 590,- |
| CE HSR* | USB, RS-232, RS-422 | 3 input / 4 output | | 560,- |
| CE HSN | USB, PROFINET | 3 input / 4 output | | 830,- |

* ONLY WHILE STOCKS LAST

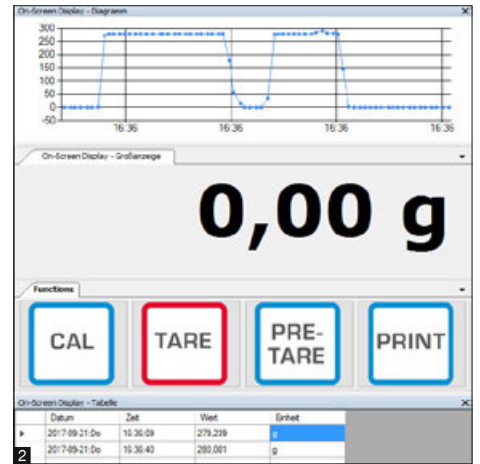

Universal weighing platforms for flexible connection in process chains

Features

- These weighing platforms can be easily integrated into your process chain. All recorded values can be easily transferred and processed further in your system as digital data and data that has already been compared using the many interfaces available. This saves cost, time and resources and ensures even more effective working
- Connecting the platform with a tablet or PC offers the advantage of being able to use the apps and programs which are on that device. This offers you the maximum level of flexibility when displaying, processing and saving the recorded weighing data
- KERN Communication Protocol (KCP): The KCP permits searching and remote control of the balance using external control devices or computers
- PRE-TARE function for manual subtraction of a known container weight, useful for checking fill-levels
- **1** A practical status LED informs about the active power supply

- Draught shield standard for models with weighing plate size **A**, weighing space W×D×H 146×146×80 mm
- **2** Software BalanceConnection for adjusting and managing the KERN KDP, for large-format display of the values collected on the PC as well as transfer of this data to other Apps and programs included with the delivery

Technical data

- Dimensions weighing surface **A** ø 105 mm, plastic, with conductive lacquer **B** W×D 160×160 mm, stainless steel, see larger picture
- Overall dimensions W×D×H 165×166×75 mm (without draught shield)
- Cable length approx. 1,2 m
- Net weight approx. 1,2 kg
- Permissible ambient temperature 5 °C/35 °C

Accessories

- Bluetooth data interface for wireless data transfer to PC or tablets, must be ordered at purchase, KERN KDP-A03, € 54,-
- WiFi data interface to transfer data from balances to PC or tablet, must be ordered at purchase, KERN YMI-A01, € 95,-
- Ethernet data interface, to connect an IP-based Ethernet network, continuous data transfer, must be ordered at purchase, KERN KDP-A02, € 110,-

*WiFi and Ethernet data interface cannot be combined

STANDARD



OPTION



FACTORY



| Model | Weighing capacity [Max] g | Readability [d] g | Reproducibility g | Linearity g | Weighing plate | Price excl. of VAT ex works € | Options | |
|-----------------|---------------------------------|-------------------------|----------------------|----------------|----------------|--|---------------|------------------|
| | | | | | | | DAkkS KERN | Certificate € |
| KERN KDP 300-3 | 350 | 0,001 | 0,002 | ± 0,005 | A | 490,- | 963-127 | 103,- |
| KERN KDP 3000-2 | 3500 | 0,01 | 0,02 | ± 0,05 | B | 490,- | 963-127 | 103,- |
| KERN KDP 10K-4 | 10000 | 0,1 | 0,1 | ± 0,3 | B | 460,- | 963-128 | 124,- |
| KERN KDP 10K-3 | 10000 | 1 | 1 | ± 3 | B | 440,- | 963-128 | 124,- |

WE CAN MAKE YOUR WEIGHING DATA DIGITAL – KERN EASYTOUCH

The KERN EasyTouch software combines the performance of KERN scales with the flexibility of a Windows or Android environment.

The modular system solution for efficient weighing – perfect for your individual requirements.

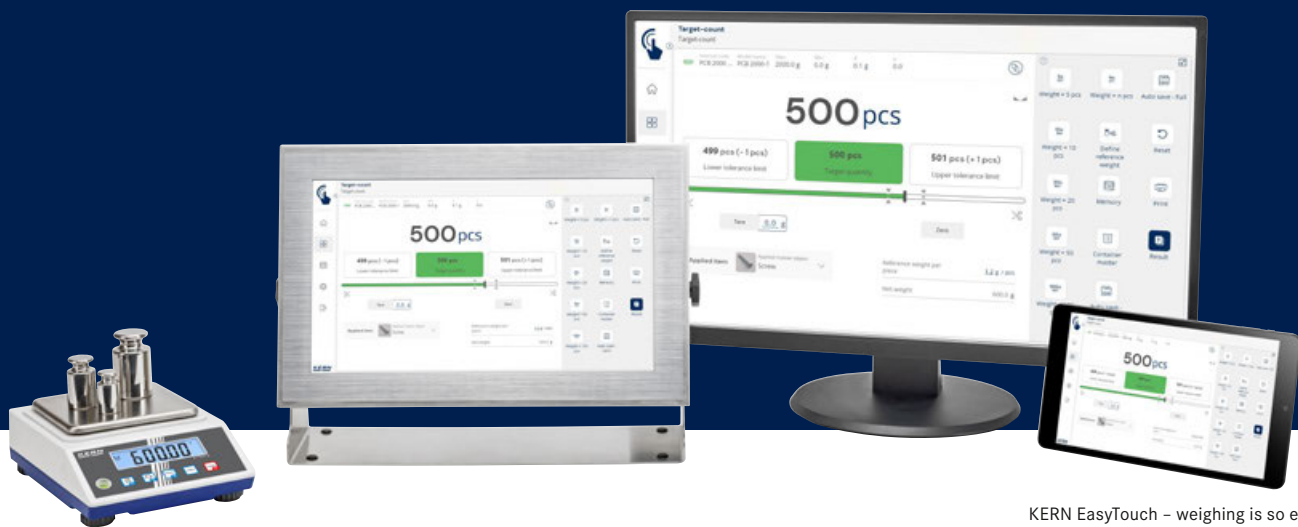

KERN EasyTouch – weighing is so easy today:
A perfectly coordinated weighing system
consisting of platform, balance and tablet

See for yourself the many benefits of the KERN EasyTouch Software:

- Greater efficiency through short workflows for the user
- Greater security of the measuring results
- Avoiding measuring and process errors
- Unlimited master data memory
- Central data storage and data security (tamper-proof)
- Interfaces to ERP, PPS, etc. systems

All details about KERN EasyTouch can be found at
<https://lp.kern-sohn.com/en/easytouch>

 **Easy
Touch**



See for yourself how convenient
and easy it is
to use KERN EasyTouch

Working with KERN EasyTouch is so easy

Collect the weight and measurement data with a device from our KERN IoT-Line

KERN EasyTouch combines and processes weights with master and product data, as well as user and time information

Supply of data to connected systems or peripheral devices



- A standard balance from our KERN IoT-Line is connected to an external laptop/tablet
- The performance of the balance is transferred to the terminal device 1:1

- The expansion of the user interface enables simple and intuitive operation of the balance and direct display and processing of measurement and master data
- The data is integrated directly in the process and this means it can continue to be used and stored

- Errors in the process or application are avoided
- In this way a simple balance becomes a highly-complex measuring device
- The recorded data can be processed further in a flexible way

KERN EasyTouch – these functions are included:

- Basic program with functions including weighing and dispensing function, as well as master data and user administration
- Over 20 optional add-on functions
- Tamper-proof data storage and seamless traceability of your measurement data and changes to your master data
- On request we can also offer tailor-made solutions – get in touch with us!

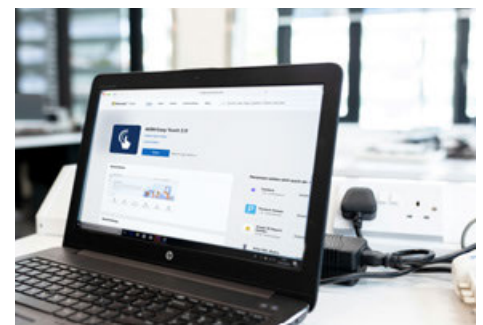

KERN EasyTouch App – download now from Microsoft Store® (for Windows®) or Google Play Store® (for Android™)

Test it without any risk and free of charge – it's that easy:

- 1 Download KERN EasyTouch from the App Store**
The free trial version contains the full range of functions.
- 2 Connect the devices you need**
Connect to devices using the four interfaces provided (Bluetooth, wired or USB adapter or WiFi).
- 3 Basic program with optional add-on functions 180-day test**
During the testing phase you can decide whether to continue using the software. With absolutely no loss of data.

Talk to the professionals

Our specialists will gladly inform and advise you on all questions regarding KERN EasyTouch

Tel. +49 7433 9933-324
etsales@kern-sohn.com



Maximilian Pfister



Wolfgang Schäfer

KERN EasyTouch – You have the following options



Possible interfaces:

- Wired through RS 232 interface cable + USB adapter AFH 13
- Bluetooth through KUP-06 or KUM-06
- Ethernet through KUP-04 or KUM-04
- WiFi through KUP-05 or KUM-05

Your benefits of the KERN EasyTouch software

- You only pay for the functions that you use
- Expansion of the range of services of your balance to meet your individual ideas and preferences
- Easy control of your balances from wherever you currently are: laboratory, production, office control of a PC, laptop or a tablet
- Tamper-proof storage of all weighing data on a central server, in an orderly database

KERN EasyTouch – available right now for the following KERN ranges/models

KERN Balances / Weighing platforms

| | | | | | |
|--------------------------|--------------------|---------------------------------|---|----------------------------|--------------------|
| Display Devices | KFC ⁽¹⁾ | Stainless steel Platform Scales | SXC ⁽¹⁾ | Precision Balances | 572 |
| Baby Scales | MBA | Compact Laboratory Balances | PCB | Wheelchair platform scales | MWN ⁽¹⁾ |
| Floor Scales | BID ⁽¹⁾ | Pallet Scales | UID ⁽¹⁾ | Chair scales | MCN ⁽¹⁾ |
| Digital Platforms | KDP | Personal Balances | MPN ⁽¹⁾ | Bench Scales | FCB ⁽¹⁾ |
| Digital Weighing Systems | KGP | Platform Scales | DS, IFB, IFC ⁽¹⁾ , IOC ⁽¹⁾ , IXC ⁽¹⁾ | Counting Scales | CDS, CKE |

⁽¹⁾ Verified operation: Weighing data from legally regulated uses can be stored and archived in KERN EasyTouch in conformity with standards, by using models from this product family with valid calibration and measurement value memory. This standard-compliant data storage also applies to SaveServer.

Depending on the model and connection type (USB, Bluetooth, Ethernet, WiFi), please contact KERN specifically, as there may currently still be restrictions on the possible combinations.

Tip: Other KERN ranges can be adapted to be EasyTouch compatible – keep up-to-date with the latest new on <https://lp.kern-sohn.com/en/easytouch>



Note: All KERN models which are EasyTouch compatible are marked with the relevant symbol in the catalogue!

EasyTouch function at a glance

Basic Package – Operating system

SET-01 EasyTouch Base

Basic Weighing & Laboratory Package

The basic package contains many useful functions such as weighing, totalizing, target dispensing and percentage weighing. As well as the local master data administration and management of the weighing results.

The basic package can be expanded at any time with additional, optional add-on functions.



Optional add-on functions

SET-07 Variable

Free variable function

Individually definable units, e.g. cable length g/m, weight per unit area g/m², etc.

SET-08 Take-Out

Take-out function

Ideal for portioning by removing from a source container

SET-11 Safety

Precision & Safety function

Scale monitoring: the MUST for the pharmaceutical sector

SET-16 Batch & Statistics

Batch measuring function with statistical analysis

Perfect function in the context of production control, for calculating averages, etc.

SET-21 Formulation

Recipe function

Recipe management, dosing aid, recipe adjustment, multiplier function, etc.

SET-22 Difference

Difference function

Monitoring of weight increase (e.g. cell growth) or weight decrease (e.g. drying) and calculation of the weight difference

SET-31 Tolerance

Tolerance weighing function

Weighing within defined limits ensures fast sorting, portioning, picking, checking

SET-32 Count

Piece-counting function

Fast counting of large quantities, avoids counting errors, saves time and money!

SET-33 Target Count

Target-counting function

For lightning-fast picking of small parts, safely supported by optical and acoustic signals

SET-17 PrePack

Production control and packaging

Perfect for use in sectors such as the food industry for weighing in accordance with pre-packaging legislation

SET-14 Individual Print

User-customised print format function

Individual positioning of print elements, form printing, paper sizes and barcode printing is possible

You can find more functions on our EasyTouch home page:



<https://lp.kern-sohn.com/en/easytouch>



Central data memory

SET-10 Save-Data Server

Weight storage and Save-Server function

Central storage of weighing and measuring data in a network

SET-28 Customization Service

Service for programming

Setting up and configuring interfaces (e.g. to merchandise management, ERP or PPS) and individual customer requirements

13

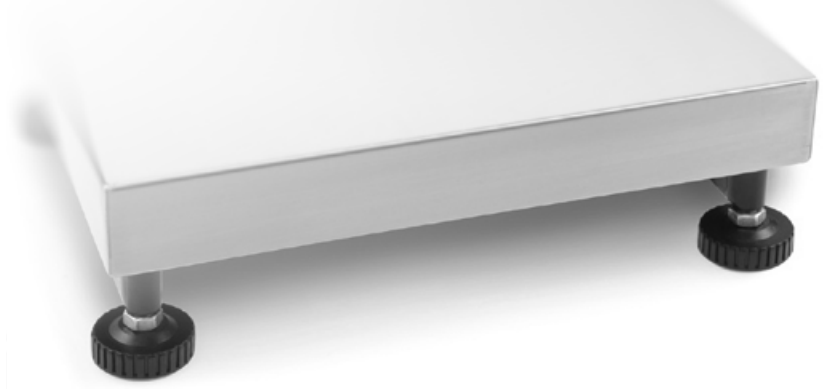

DISPLAY DEVICES, PLATFORMS, WEIGHING BRIDGES

Customized individual weighing systems, without verification

KERN offers a range of KERN display devices and KERN weighing units, such as platform scales, floor scales, pallet scales and drive-through scales, which you can customize to make your ideal scale. You choose the components, KERN handles the rest.

Assembly

KERN delivers the complete scale which is ready to use. Prices for assembly can be found in the "Assembly" price table. On request we can also create a calibration certificate in accordance with DAkkS at an additional price, see *DAkkS Calibration Service*.

Customizing individual weighing systems which can be verified or are verified

In order to provide the complete package, as well as assembling your individual weighing system, KERN will also carry out the manufacturer's initial verification/evaluation for conformity in accordance with EC directives as a commercial scales of verification class III.

In accordance with the European verification regulations, when assembling a display device with a weighing unit you must take the following notes into account:

- Only elements which can be verified with type approval or OIML test certificate can be combined into a weighing system which can be verified. Possible models are marked with "M".
- Platforms with load cells, provided as third-party products which have an OIML test certificate can be included.
- It will not be possible to carry out verification at a later date, e.g. after assembly and delivery of the weighing system. So please order the verification at the same time as you order the weighing system.

You will find a wide variety of display devices, platforms, weighing bridges, etc. in KERN's product range and these can be put together to create your ideal scale. You simply choose the components, KERN handles the rest.



The individual KERN steps:

| | Weighing capacity | Model | Price excl. of VAT, ex works € |
|---|-------------------------|---------|---|
| 1. Proof of compatibility This is mandatory by law and includes testing by using type approvals, whether the connection values of the display device match the connection data of the weighing unit. | 0 up ... kg | KERN | |
| | all Weighing capacities | 965-240 | 49,- |
| 2. Assembly After testing for suitability using the proof of compatibility, the weighing system will be hard wired by KERN. The weighing system will then be tested in accordance with regulations of 2014/31/EU, the European directive for non-automatic weighing instruments and prepared for conformity assessment. | up ≤ 50 kg | 965-411 | 84,- |
| | up ≤ 350 kg | 965-412 | 119,- |
| | up ≤ 1500 kg | 965-413 | 143,- |
| | up ≤ 2900 kg | 965-414 | 178,- |
| | up ≤ 6000 kg | 965-415 | 300,- |
| 3. Initial verification by the manufacturer Conformity assessment ("Initial verification by the manufacturer") KERN is authorised to carry out the conformity assessment ("initial verification by the manufacturer") in accordance with 2014/31/EU, the European directive for non-automatic weighing instruments and is therefore authorised to introduce the weighing system onto the market, after the test has been carried out successfully and the conformity mark has been affixed. | up ≤ 5 kg | 965-227 | 65,- |
| | up ≤ 50 kg | 965-228 | 84,- |
| | up ≤ 350 kg | 965-229 | 110,- |
| | up ≤ 1500 kg | 965-230 | 158,- |
| | up ≤ 2900 kg | 965-231 | 178,- |
| | up ≤ 6000 kg | 965-232 | 235,- |
| 4. Declaration of conformity KERN issues this after the initial verification by the manufacturer Conformity assessment has been carried out successfully and sends it with the weighing system at no additional cost, and it can be used in areas regulated by law. | | | |

Modifications and special services

| Description | Model | Price excl. of VAT, ex works € |
|---|---------|---|
| | KERN | |
| Cable extensions for platform scales | | |
| up to 4 m extension | 965-403 | 54,- |
| up to 7 m extension | 965-404 | 71,- |
| up to 20 m extension | 965-405 | 89,- |
| Individual settings | | |
| Scale with NAWI conformity evaluation, only in combination with KERN 965-240 | 965-401 | 60,- |
| Other adjustments in the balance or software changes | 965-407 | 113,-/h |
| Plug connection (replaces the fixed cable connection between the display device and platform with a plug connection which can be disconnected) | | |
| Balances with type approval and verification (according to time spent) | | only possible with separable, verifiable plug connection with identification chip (e.g. KERN KIB-A12), for the corresponding models (e.g. IOC, BID, UID) please order when purchasing |
| Balances with type approval, no verification | 965-406 | 71,- |

! Delivery time for modifications & special services approx. 5-8 working days

Order example

| | Model | Price excl. of VAT, ex works € |
|---|------------|---|
| KFP 30V20M platform and KEN-TM display device with cable extension (4 m) and setting an individual preload. | KERN | |
| KERN platform | KFP 30V20M | 315,- |
| KERN display device | KFN-TM | 360,- |
| Proof of compatibility | 965-240 | 49,- |
| Cable extension | 965-403 | 54,- |
| Setting the preload | 965-401 | 60,- |
| Assembly | 965-411 | 84,- |
| Verification at the factory KERN | 965-228 | 84,- |
| Complete scale (verified) | | 1006,- |

NOTHING IS IMPOSSIBLE – KERN CUSOS

Perfectly working weighing solutions with customized platform sizes, specific software solutions and coordinated peripherals – to suit your processes.

Our KERN Customized Solution Service offers maximum freedom of choice – give it a try.

Zoologischer Garten Schwerin/Sven P. Peter

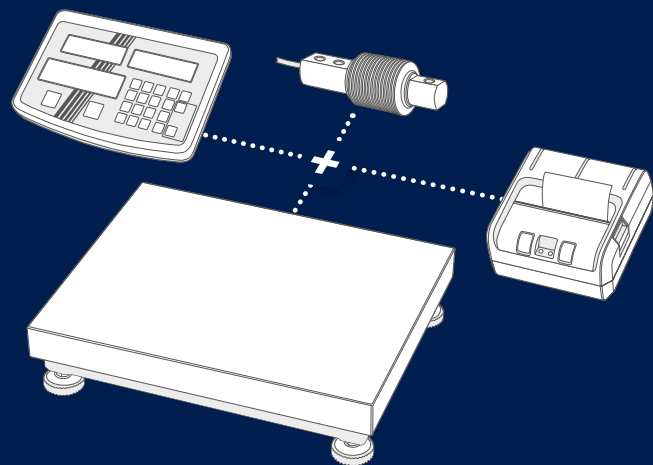

KERN CUSOS – Perfectly tailored to you and your requirements

Powerful balances and efficient weighing systems which support you in your work, should be adapted to your individual requirements. Standard models are therefore not sufficient under some circumstances.

For this reason, at KERN it is our pleasure to work with you to develop a solution which is appropriate and tailor-made for you. From a range of platform sizes through to personalised weighing systems within large production plants, we can provide the right measuring technology.

Through close collaboration with your engineers and users, we first check the special requirements for your application. Using this data we will put together the appropriate platform scale, floor scale or a completely personalised weighing system for you, to fit your requirements perfectly.

Tip: Save money and ask our experts. Maybe your desired combination is already included in our standard range?



**CUSTOMIZED
SOLUTION SERVICE**

For details scan QR Code:

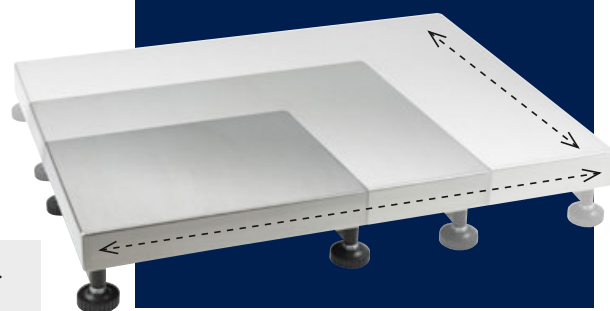



For perfect integration into existing and newly configured processes: individual platform construction in individual formats



Ideal for customised requirements



From horses to rhinos - weighing large animals is child's play with our tailor-made solutions



Your advantage – you have the choice

Choose from a wide range of display devices. Economical and lightweight (plastic version), robust and water-resistant (stainless steel version), with numeric key pad, battery or mains operation or the most varied interfaces.

Load cells to construct automatic weighing systems such as filling or dosing systems, such as might be used, for example, in manufacturing or filling processes in the chemical industry, construction industry, mineral industry, etc.

On many occasions, load cells are also used in the construction of checkweighers or for installation into packaging machines of any type in the food industry.

The weighing data can be forwarded to peripheral devices such as signal lamps, printers and laptops or be used to switch valves, or similar devices.

What's your individual requirement?

Just tell us the size you want and the material you want for your platform and other essential construction details – done! We'll take care of the implementation.

Following you will find a selection of our platforms, load cells and evaluation devices – the starting point for your individual system solution!

Our competent CUSOS team is at your disposal and is looking forward to your project:

Tel: +49 7433 9933-570

E-Mail: cusos@kern-sohn.com



Max Matthes



Fabian Brenner



Further information and products:
www.kern-sohn.com



1 KERN KFB-TM

Display device with large digits – easy to read and optional analogue output for controlling systems (PLC) etc.

2 KERN KFS-TM

Professional indicator with 3 displays, also with EC type approval [M]

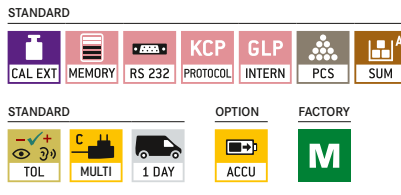
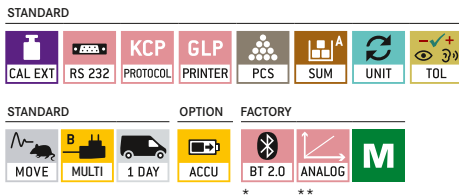

| Features | Model KERN 1 KFB-TM | Model KERN 2 KFS-TM |
|--|---|---|
| Display (segments) | 5 + ½ digits | 6 digits |
| EC type approval | yes | yes |
| Resolution verifiable | 6000 e | 3000 e |
| Resolution non verifiable | 30000 d | 60000 d |
| Weighing capacities | ≤ 2 | ≤ 2 |
| Weighing units | kg, lb | kg, g |
| Readability | 1, 2, 5, 10, n | 1, 2, 5, 10, n |
| Piece counting with reference | 10, 20, 50, 100, 200 | n |
| Display, digit height | Backlit LCD display, 52 mm | Backlit LCD displays, 13/16,5 mm |
| Additional functions | Totalising, HOLD function, Integrated KERN Communication Protocol (KCP), ideal for connecting an Merchandise Management or ERP system, Compatible with the KERN EasyTouch App | 99 item memories, totalising, printing of date and time, Integrated KERN Communication Protocol (KCP), ideal for connecting an Merchandise Management or ERP system, Compatible with the KERN EasyTouch App |
| Strain gauge load cells | 87 – 1600 Ω | 87 – 1600 Ω |
| Linearisation | 3 points | 4 points |
| Input voltage | 12 V, 500 mA | 12 V, 500 mA |
| Permissible ambient temperature | -10 °C/40 °C | 0 °C/40 °C |
| Interface RS-232 | yes | yes |
| 2. Interface RS-232, separate Y cable | CFS-A04, € 38,- | CFS-A04, € 38,- |
| Interface RS-485 | - | - |
| Interface USB | - | - |
| Interface Bluetooth | KERN KFB-A03, € 160,- | - |
| Analogue module | 0-10V: KERN KFB-A04, € 170,-; 4-20 mA: KERN KFB-A05, € 170,-; | - |
| Signal lamp | CFS-A03, € 310,- | CFS-A03, € 310,- |
| Foot switch | - | - |
| Stand | BFS-A07, € 170,- | BFS-A07, € 170,- |
| Benchtop stand for display device/wall mount | yes/yes | yes/yes |
| Protective working cover | KFB-A02S05, € 52,- | KFB-A02S05, € 52,- |
| Rechargeable battery pack | KFB-A01, € 40,- | KFB-A01, € 40,- |
| Operating/charging time | up to 35 h/12 h | up to 40 h/12 h |
| Dimensions Housing W×D×H | 250×160×65 mm | 260×150×65 mm |
| Net weight | 1,2 kg | 1,5 kg |
| Price, excl. of VAT, ex works, € | 260,- | 280,- |

* not possible in combination with verification. When installing the Bluetooth data interface, the RS-232 data interface can no longer be used

** not possible in combination with signal lamp. When installing the analogue module, the RS-232 data interface can no longer be used



3 KERN KIB-TM

Practical Flip/Flop Display device for greatest ease of use

Features

- Practical Flip/Flop display device: flexible positioning e.g. free-standing or screwed to the wall (optional). By rotating the upper housing shell you can determine the angle of the display as well as the cable outlet. Factory Option ex works for an additional cost, delivery time + 2 working days, KERN KIB-M01, € 104,-
- Industry 4.0: A large number of (optional) data interfaces enable convenient transferring weighing data to tablets, laptops, PCs, networks, smartphones, printers, etc.
- Searching and remote control of the balance using external control devices or computers with the KERN Communication Protocol (KCP).

4 KERN KFN-TM

Stainless steel display device with IP65 protection and superior display size and optional analogue output for controlling systems (PLC) etc.



| | | | |
|----------|--|---|--|
| STANDARD | | OPTION | |
| FACTORY | | <p>* Note: In addition to the RS-232 data interface, which is integrated as standard, only one other data interface can be installed and operated</p> | |
| STANDARD | | STANDARD | |
| | | FACTORY | |

| Features | Model KERN 3 KIB-TM*** | Model KERN 4 KFN-TM |
|--|--|--|
| Display (segments) | 6 digits | 5 + 1/2 digits |
| EC type approval | yes | yes |
| Resolution verifiable | 6000 e | 6000 e |
| Resolution non verifiable | 60000 d | 30000 d |
| Weighing capacities | ≤ 2 | ≤ 2 |
| Weighing units | kg, g | kg |
| Readability | 1, 2, 5, 10, n | 1, 2, 5, 10, n |
| Piece counting with reference | 5, 10, 20, 25, 50, 100 | 10, 20, 50, 100, 200 |
| Display, digit height | Backlit LCD display, 24 mm | Backlit LCD display, 52 mm |
| Additional functions | Totalising, HOLD function, printing of time. KCP Only possible through RS-232; USB, Bluetooth, WiFi, Digital I/O, LAN on request | Totalising, HOLD function |
| Strain gauge load cells | 87 - 1100 Ω | 87 - 1600 Ω |
| Linearisation | 3 points | 3 points |
| Input voltage | 12 V DC, 1000 mA | 12 V, 500 mA |
| Permissible ambient temperature | -10 °C/40 °C | -10 °C/40 °C |
| Interface RS-232 | yes* | KFN-A01, € 225,- |
| Interface RS-485 | - | - |
| Interface USB | KIB-A03*, € 120,- | - |
| Interface Bluetooth | KIB-A04, € 110,- | - |
| WiFi | KIB-A10*, € 130,- | - |
| SWITCH (DIGITAL I/O) | - | - |
| LAN | KIB-A02*, € 165,- | - |
| Alibi memory | KIB-A01, € 175,- | - |
| Analogue module | - | 0-10V: KERN KFB-A04, € 170,-; 4-20 mA: KERN KFB-A05, € 170,-; |
| Stand | EOC-A05, € 65,- | BFS-A07, € 170,- |
| Benchtop stand for display device/wall mount | EOC-A04, € 33,- | yes/yes |
| Protective working cover | EOC-A01S05, € 55,- | - |
| Rechargeable battery pack | KFB-A01, € 40,- | GAB-A04, € 42,- |
| Operating/charging time | up to 43 h/3 h | up to 35 h/12 h |
| Dimensions Housing W×D×H | 268×115×70 mm | 266×165×96 mm |
| Net weight | 0,8 kg | 2,6 kg |
| Price, excl. of VAT, ex works, € | 220,- | 360,- |

- * not possible in combination with verification. When installing the Bluetooth data interface, the RS-232 data interface can no longer be used
- ** not possible in combination with signal lamp. When installing the analogue module, the RS-232 data interface can no longer be used

*** ONLY WHILE STOCKS LAST



- Simplified battery replacement through easily-accessible housing. Particularly advantageous for models with optional verification, as the verification seal remains intact
- With Real Time Clock as standard: Enables you to log the weighing results with accurate time information. Even if the power supply is interrupted, the balance can continue to work with the correct time

Accessories

- Stand to elevate display device, height of stand approx. 1040 mm, KERN BFS-A07, € 170,-
- Internal rechargeable battery pack, operating time up to 48 h without backlight, charging time approx. 8 h, KERN YKR-01, € 35,-
- External data interface RS-232, interface cable included, KERN KUP-01, € 60,-
- External data interface USB, interface cable included, KERN KUP-03, € 75,-
- External data interface Ethernet, KERN KUP-04, € 115,-
- External data interface WiFi, interface cable included, KERN KUP-05, € 75,-
- Bluetooth interface adapter, KERN KUP-06, € 99,-
- Analogue module, KERN KUP-08, € 170,-
- *Extension box for connecting up to three interfaces in parallel, KERN KUP-13, € 75,-
- Memory module (alibi memory), KERN YMM-04, € 80,-
- Signal lamp for visual support of weighing with tolerance range, connection is only possible in combination with KUP-01 (RS 232 interface), KERN CFS-A03, € 310,-



Display device with up to three interfaces and optional verification

Features

- Standardised, convenient KERN concept of operation, consistency across products in terms of design, menu structure, button functions, interface connection and interface protocol
- Industry 4.0: Data and control commands can be exchanged through the KERN Universal Port using one interface, which can be connected to the housing, or through three parallel interfaces using the KUP Extension box
- The following interfaces are available as an option: RS-232, USB, Analogue module, Ethernet, WiFi, Bluetooth

- Each interface can be set up separately, e.g.:
 - Interface 1 (WiFi): Continuous sending to PC for documentation of a process
 - Interface 2 (RS 232): Print stable weight
 - Interface 3 (analogue module): Controlling a device when the target weight is reached
- Available as an option with alibi memory for paperless archiving of weighing results. This also means the results of weighings with mandatory verification can be electronically evaluated and processed further
- Data query and remote control of the balance using a computer or CRM/ERP systems using the KERN Communication Protocol

13

| | | |
|----------|--------|---------|
| STANDARD | OPTION | FACTORY |
| | | |

Features

Model KERN KFC-TM

| | |
|---|---|
| Display (segments) | 6 |
| EU type approval | yes |
| Resolution (verifiable) | 3.000 / 2 × 3.000 |
| Resolution (non verifiable) | 100 - 999.999 |
| Weighing capacities | single-range / 2 × multi-range / 2 × multi-division |
| Weighing units | kg, g, lb, ffa, PCS, % Verifiable: kg, g |
| Piece counting with reference | 5, 10, 20, 50, n |
| Display, digit height | 50 mm |
| Strain gauge load cells | 87 - 1100 Ω |
| Linearisation (points) | 2 / 3 / 5 |
| Input voltage | 110 V - 240 V AC |
| Accu operation time - without backlight | 48 h |
| Accu charging time | 8 h |
| Dimensions Housing W×D×H | 220×145×65 mm |
| Net weight | 0,7 kg |
| Permissible ambient temperature | -10°C/40°C |
| Price, excl. of VAT, ex works, € | 230,- |



Accessories

- Internal rechargeable battery pack, operating time up to 48 h without backlight, charging time approx. 8 h, KERN YKR-01, € 35,-
- GB mains adapter, cable length 1,5 m, KERN KXS-A06, € 109,-
- Stand to elevate display device, height of stand approx. 1040 mm, KERN BFS-A07, € 170,-
- Internal data interface RS-232, interface cable included, KERN KUM-01, € 120,-
- Internal data interface USB, interface cable included, KERN KUM-03, € 120,-
- Internal data interface Ethernet, interface cable included, KERN KUM-04, € 165,-
- Internal data interface WiFi, KERN KUM-05, € 95,-
- Internal data interface Bluetooth, KERN KUM-06, € 135,-
- Analogue module, KERN KUM-08, € 145,-
- Memory module with real time clock (alibi memory), KERN YMM-06, € 160,-

*Note: only two wired connections (RS-232, Ethernet, USB or analogue module) and two wireless connections (WiFi or Bluetooth) can be used at the same time

Stainless steel display device with IP68 dust and spray protection and up to four interfaces

Features

- With dust and spray protection (IP68), which makes it ideal for use in industry and outdoors
- Standardised, convenient KERN concept of operation, consistency across products in terms of design, menu structure, button functions, interface connection and interface protocol
- Industry 4.0: The exchange of data and control commands is optional using up to four interfaces to suit individual requirements: two wired connections (RS 232, Ethernet, USB or analogue module) and two wireless connections (WiFi or Bluetooth)

- Each interface can be set up separately, e.g.:
 - Interface 1 (WiFi): Continuous sending to PC for documentation of a process
 - Interface 2 (RS-232): Print stable weight
 - Interface 3 (analogue module): Controlling a device when the target weight is reached
 - Interface 4 (Bluetooth): Continuous sending to a tablet to monitor a process
- Data query and remote control of the balance using a computer or CRM/ERP systems using the KERN Communication Protocol
- Available as an option with alibi memory for paperless archiving of weighing results. This also means the results of weighings with mandatory verification can be electronically evaluated and processed further



Features

Model KERN KXC-TM

| | |
|---|---|
| Display (segments) | 6 |
| EU type approval | yes |
| Resolution (verifiable) | 3.000 / 2 × 3.000 |
| Resolution (non verifiable) | 100 - 999.999 |
| Weighing capacities | single-range / 2 × multi-range / 2 × multi-division |
| Weighing units | kg, g, lb, ffa, PCS, % |
| Piece counting with reference | 5, 10, 20, 50, n |
| Display, digit height | 48 mm |
| Strain gauge load cells | 87 - 1100 Ω |
| Linearisation (points) | 2 / 3 / 5 |
| Input voltage | 110 V - 240 V AC |
| Accu operation time - without backlight | 48 h |
| Accu charging time | 8 h |
| Dimensions Housing W×D×H | 232×150×80 mm |
| Net weight | 2,6 kg |
| Permissible ambient temperature | -10°C/40°C |
| Price, excl. of VAT, ex works, € | 400,- |



1 KERN KBP-V20 IP65

Platform

Features

- Stainless steel-weighing plate, **A** painted steel base
- 1 load cell, aluminium, silicone-coated, IP65, OIML-R60-approved, class III, 3000 e
- Level indicator and levelling feet for precise levelling of the scale, fitted as standard
- Preparation for easy assembly of the ESD earthing kit on the weighing bridge



STANDARD

IP 65 1 DAY 2 DAYS

KPB 600



2 KERN KFP-V20 IP65

Platform

Features

- Stainless steel-weighing plate, **B** painted steel base
- 1 load cell, aluminium, silicone-coated, IP65, OIML-R60-approved, class III, 3000 e
- Level indicator and levelling feet for precise levelling of the scale, fitted as standard



STANDARD

IP 65 1 DAY 2 DAYS

KPB 600



3 KERN KXP-V20 IP65

Platform

Features

- Stainless steel-weighing plate, **C** painted steel base, extremely rigid, wing design
- 1 load cell, aluminium, silicone-coated, IP65, OIML-R60-approved, class III, 3000 e
- Level indicator and levelling feet for precise levelling of the scale, fitted as standard



STANDARD

IP 65 1 DAY

KPB 600



| Model | Weighing capacity | Readability | Verification value | Minimal load | Cable length | Net weight | Weighing plate | Price excl. of VAT ex works € |
|--------------------------------|-------------------|-------------|--------------------|--------------|--------------|------------|----------------|-------------------------------|
| | [Max] kg | [d] g | [e] g | [Min] g | approx. m | approx. kg | W×D×H mm | |
| 1 Platform KBP-V20 IP65 | | | | | | | | |
| KBP 6V20LM | 3 6 | 0,2 | 1 2 | 20 40 | 2,5 | 3,8 | 300×300×110 | 200,- |
| KBP 15V20M | 6 15 | 0,5 | 2 5 | 40 100 | 2,5 | 3,8 | 300×240×110 | 200,- |
| KBP 15V20LM | 6 15 | 0,5 | 2 5 | 40 100 | 2,5 | 7 | 400×300×110 | 220,- |
| KBP 30V20M | 15 30 | 1 | 5 10 | 100 200 | 2,5 | 7 | 400×300×110 | 220,- |
| KBP 60V20M | 30 60 | 2 | 10 20 | 200 400 | 2,5 | 7 | 400×300×110 | 230,- |
| KBP 60V20LM | 30 60 | 2 | 10 20 | 200 400 | 2,5 | 10 | 500×400×120 | 290,- |
| KBP 150V20M | 60 150 | 5 | 20 50 | 400 1000 | 2,5 | 10 | 500×400×120 | 320,- |
| KBP 150V20LM | 60 150 | 5 | 20 50 | 400 1000 | 2,5 | 19 | 650×500×150 | 480,- |
| KBP 300V20M | 150 300 | 10 | 50 100 | 1000 2000 | 2,5 | 19 | 650×500×150 | 480,- |
| KBP 600V20M | 300 600 | 20 | 100 200 | 2000 4000 | 2,5 | 42 | 800×600×200 | 680,- |
| 2 Platform KFP-V20 IP65 | | | | | | | | |
| KFP 3V20M | 3 | 0,1 | 1 | 20 | 2,5 | 3,4 | 230×230×103 | 205,- |
| KFP 6V20M | 6 | 0,2 | 1 2 | 20 40 | 2,5 | 4,4 | 230×230×103 | 205,- |
| KFP 6V20LM | 6 | 0,2 | 1 2 | 20 40 | 2,5 | 3,8 | 300×240×105 | 250,- |
| KFP 15V20M | 6 15 | 0,5 | 2 5 | 40 100 | 2,5 | 3,8 | 300×240×105 | 285,- |
| KFP 15V20LM | 6 15 | 0,5 | 2 5 | 40 100 | 2,5 | 7 | 400×300×114 | 315,- |
| KFP 30V20SM | 15 30 | 1 | 5 10 | 100 200 | 2,5 | 3,8 | 300×240×105 | 250,- |
| KFP 30V20M | 15 30 | 1 | 5 10 | 20 | 2,5 | 7 | 400×300×114 | 315,- |
| KFP 30V20LM | 15 30 | 1 | 5 10 | 20 | 2,5 | 10 | 500×400×124 | 395,- |
| KFP 60V20M | 30 60 | 2 | 10 20 | 200 400 | 2,5 | 7 | 400×300×114 | 330,- |
| KFP 60V20LM | 30 60 | 2 | 10 20 | 200 400 | 2,5 | 10 | 500×400×124 | 405,- |
| KFP 150V20M | 60 150 | 5 | 20 50 | 400 1000 | 2,5 | 10 | 500×400×124 | 415,- |
| KFP 150V20LM | 60 150 | 5 | 20 50 | 400 1000 | 2,5 | 19 | 650×500×136 | 600,- |
| KFP 300V20M | 150 300 | 10 | 50 100 | 1000 2000 | 2,5 | 19 | 650×500×136 | 600,- |
| KFP 600V20AM | 600 | 20 | 200 | 4000 | 2,5 | 42 | 800×600×189 | 910,- |
| 3 Platform KXP-V20 IP65 | | | | | | | | |
| KXP 6V20LM* | 3 6 | 0,2 | 1 2 | 20 40 | 3 | 3,8 | 300×240×90 | 310,- |
| KXP 15V20M* | 6 15 | 0,5 | 2 5 | 40 100 | 3 | 6 | 300×240×90 | 320,- |
| KXP 15V20LM* | 6 15 | 0,5 | 2 5 | 40 100 | 3 | 8 | 400×300×90 | 430,- |
| KXP 30V20M* | 15 30 | 1 | 5 10 | 100 200 | 3 | 8 | 400×300×90 | 430,- |
| KXP 30V20LM* | 15 30 | 1 | 5 10 | 100 200 | 3 | 22 | 500×400×125 | 570,- |
| KXP 60V20M* | 30 60 | 2 | 10 20 | 200 400 | 3 | 11 | 400×300×90 | 440,- |
| KXP 60V20LM* | 30 60 | 2 | 10 20 | 200 400 | 3 | 17 | 500×400×125 | 600,- |
| KXP 150V20M* | 60 150 | 5 | 20 50 | 400 1000 | 3 | 18 | 500×400×125 | 570,- |
| KXP 150V20LM* | 60 150 | 5 | 20 50 | 400 1000 | 3 | 34 | 650×500×135 | 710,- |
| KXP 300V20M* | 150 300 | 10 | 50 100 | 1000 2000 | 3 | 34 | 650×500×135 | 710,- |

* ONLY WHILE STOCKS LAST!

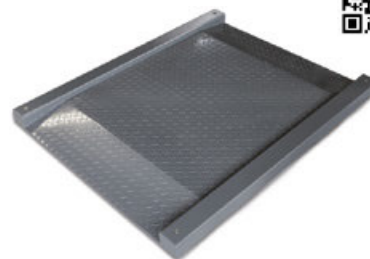
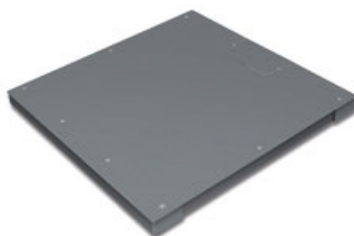
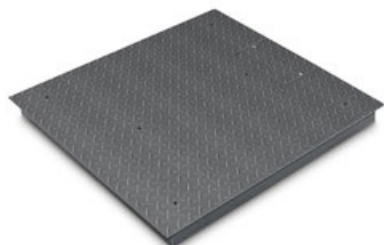

4 KERN KIP-V20M

Weighing Bridge

Features

- Weighing bridge with non-slip chequer plate, lacquered, welded
- 4 Load cells, steel, silicone-coated, IP67, OIML-R60-approval for verification, class III, 3000 e
- Can be built in using pit frames (optional)
- Level indicator and levelling feet for precise levelling of the scale
- Easy access to the junction box from the top
- Comfortable levelling of the weighing bridge from the top

5 KERN KFP-V20 IP67

Weighing Bridge

Features

- Weighing plate screwed on from the top (models with [Max] ≤ 1500 kg), so it easy to remove, hygienic and easy to clean.
- Lacquered steel weighing bridge, weighing plate size 1500×1500×130 mm corrugated steel plate. Extremely resistant to bending due to material thickness
- 4 Load cells, steel, silicone-coated, IP67, OIML-R60-approval for verification, class III, 3000 e
- Can be built in using pit frames (optional)
- Level indicator and levelling feet for precise levelling of the scale
- Easy access to the junction box from the top
- Comfortable levelling of the weighing bridge from the top

6 KERN KFD-V20

Weighing Bridge

Features

- Weighing bridge made of non-slip corrugated steel plate, lacquered, two access ramps integrated, extremely resistant to bending
- Extremely flat construction to facilitate access: access height only 45 mm
- 4 Load cells, alloy steel, silicone-coated, IP67, OIML-R60-approved class III, 3000 e



STANDARD FACTORY

IP 67 2 DAYS M

STANDARD FACTORY

IP 67 2 DAYS M

STANDARD FACTORY

IP 67 2 DAYS M

| Model | Weighing range [Max] kg | Readability [d] g | Verification value [e] g | Min. load [Min] g | Cable length approx. m | Net weight approx. kg | Weighing plate W×D×H mm | Price excl. VAT, ex works € |
|---------------------------------------|-------------------------|-------------------|--------------------------|-------------------|------------------------|-----------------------|-------------------------|-----------------------------|
| 4 Weighing bridge KIP-V20M | | | | | | | | |
| KIP 1500V20SM | 1500 | 500 | 500 | 10000 | 5 | 130 | 1000×1000×108 | 1 170,- |
| KIP 1500V20EM | 1500 | 500 | 500 | 10000 | 5 | 140 | 1200×1000×108 | 1 250,- |
| KIP 1500V20M | 1500 | 500 | 500 | 10000 | 5 | 150 | 1500×1200×108 | 1 550,- |
| KIP 3000V20M | 3000 | 1000 | 1000 | 20000 | 5 | 150 | 1500×1200×108 | 1 550,- |
| KIP 3000V20LM | 3000 | 1000 | 1000 | 20000 | 5 | 180 | 1500×1500×108 | 1 780,- |
| 5 Weighing bridge KFP-V20 IP67 | | | | | | | | |
| KFP 1500V20SNM <small>NEW</small> | 1500 | 500 | 500 | 10000 | 5 | 100 | 1000×1000×85 | 1 370,- |
| KFP 1500V20NM | 1500 | 500 | 500 | 10000 | 5 | 135 | 1500×1250×90 | 1 910,- |
| KFP 3000V20NM | 3000 | 1000 | 1000 | 20000 | 5 | 135 | 1500×1250×90 | 1 860,- |
| KFP 3000V20LNM | 3000 | 1000 | 1000 | 20000 | 5 | 155 | 1500×1500×80 | 2 150,- |
| 6 Weighing bridge KFD-V20 | | | | | | | | |
| KFD 600V20M* | 600 | 200 | 200 | 4000 | 5 | 125 | 1600×1200×78 | 1 860,- |
| KFD 600V20LM* | 600 | 200 | 200 | 4000 | 5 | 155 | 1800×1400×80 | 2 170,- |
| KFD 1500V20M* | 1500 | 500 | 500 | 10000 | 5 | 125 | 1600×1200×78 | 1 860,- |
| KFD 1500V20LM* | 1500 | 500 | 500 | 10000 | 5 | 175 | 1800×1400×78 | 2 170,- |

! * ONLY WHILE STOCKS LAST! NEW New model



7 KERN KFA-V20

Weighing Beams

Features

- Weighing beams and painted steel base
- 4 load cells, alloy steel, silicone-coated, IP67
- Levelling feet for precise levelling of the weighing beams
- Connection cable, length 5 m
- **D** Image below: Version up to 6 t available. Each weighing beam has a roller and handle for easy transport of the scale (KERN KFA-L)
- **Special feature:** model with short weighing beams, ideal for weighing compact items or animals in transport boxes
 - ▶ KERN KFA-600V20S
- Accessories see KERN UFA

8 KERN KFU-V20/V30

U-Weighing Bridge

Features

- Load range: painted steel (V20), stainless steel (V30) height 90 mm
- 4 load cells, alloy steel, silicone-coated, IP67, OIML-R60-approval for verification, class III, 3000 e
- 2 rollers and handle for easy transport of the scale

9 KERN KFP-V30

Platform

Features

- Stainless steel-weighing plate, **E** stainless steel substructure
- 1 load cell, stainless steel, silicone-coated, IP67, OIML-approved, class III, 3000 e
- Level indicator and levelling feet for precise levelling of the scale



STANDARD

IP 67 2 DAYS

STANDARD

IP 67 2 DAYS

FACTORY

M



STANDARD

IP 67 1 DAY

FACTORY

M

13

| Model | Weighing range [Max] kg | Readability [d] g | Verification value [e] g | Min. load [Min] g | Cable length approx. m | Net weight approx. kg | Weighing plate W×D×H mm | Price excl. VAT, ex works € |
|--|-------------------------|-------------------|--------------------------|-------------------|------------------------|-----------------------|-------------------------|-----------------------------|
| 7 Weighing beams KFA-V20 | | | | | | | | |
| KFA 600V20S* | 600 | 200 | - | - | 5 | 30 | 800×120×100 | 820,- |
| KFA 1500V20* | 1500 | 500 | - | - | 5 | 36 | 1200×120×100 | 900,- |
| KFA 3000V20* | 3000 | 1000 | - | - | 5 | 36 | 1200×120×100 | 1100,- |
| KFA 3000V20L* | 3000 | 1000 | - | - | 5 | 65 | 2000×120×100 | 1350,- |
| KFA 6000V20* | 6000 | 2000 | - | - | 5 | 85 | 1200×160×80 | 1470,- |
| KFA 6000V20L* | 6000 | 2000 | - | - | 5 | 125 | 2100×160×85 | 1870,- |
| 8 U-Weighing bridge KFU-V20 | | | | | | | | |
| KFU 600V20M | 600 | 200 | 200 | 4000 | 5 | 55 | 840×1350×90 | 1130,- |
| KFU 1500V20M | 1500 | 500 | 500 | 10000 | 5 | 55 | 840×1350×90 | 1100,- |
| 8 Stainless steel U-Weighing bridge KFU-V30 | | | | | | | | |
| KFU 1500V30M* | 1500 | 500 | 500 | 10000 | 5 | 55 | 840×1350×90 | 1730,- |
| 9 Stainless steel platform KFP-V30 | | | | | | | | |
| KFP 15V30M | 15 | 1 | 5 | 100 | 2,5 | 5,0 | 300×240×100 | 700,- |
| KFP 30V30M | 30 | 1 | 10 | 200 | 2,5 | 10 | 400×300×128 | 760,- |
| KFP 30V30SM | 30 | 2 | 10 | 200 | 2,5 | 5,0 | 300×240×100 | 690,- |
| KFP 60V30M | 60 | 2 | 20 | 400 | 2,5 | 10 | 400×300×128 | 760,- |
| KFP 60V30LM | 60 | 5 | 20 | 400 | 2,5 | 10 | 500×400×137 | 950,- |
| KFP 60V30XLM | 60 | 5 | 20 | 400 | 2,5 | 22 | 650×500×142 | 1370,- |
| KFP 150V30SM | 150 | 10 | 50 | 1000 | 2,5 | 10 | 400×300×128 | 710,- |
| KFP 150V30M | 150 | 10 | 50 | 1000 | 2,5 | 10 | 500×400×137 | 940,- |
| KFP 150V30LM | 150 | 10 | 50 | 1000 | 2,5 | 22 | 650×500×135 | 1280,- |
| KFP 300V30M | 300 | 20 | 100 | 2000 | 2,5 | 22 | 650×500×135 | 1200,- |

I * ONLY WHILE STOCKS LAST!



10 KERN KFP-V40 IP68

Stainless steel platform

Features

- Platform: entirely out of stainless steel
- 1 load cell, stainless steel, encapsulated, IP68, OIML R60 approval for verification, class III, 3000 e
- Level indicator and levelling feet for accurate levelling of the balance

11 KERN KFP-V40 IP68

Stainless steel weighing bridge

Características

- Weighing bridge entirely made of stainless steel, extremely resistant to bending because of its high material thickness
- **g** Weighing plate fixed with stainless steel screws, for easier access to the loadcells from above
- 4 Load cells, stainless steel, encapsulated, IP68, OIML R60 approval for verification, Class III, 3000 e
- Can be built in using pit frames (optional)
- Level indicator and levelling feet for accurate levelling of the balance
- Comfortable levelling of the weighing bridge from the top

12 KERN KFD-V40 IP68

Stainless steel weighing bridge

Características

- Weighing bridge made from stainless steel, two integrated access ramps, extremely resistant to bending
- Extremely flat construction to facilitate access: access height only 45 mm
- 4 Load cells, stainless steel, encapsulated, IP68, OIML R60 approval for verification, Class III, 3000 e
- Level indicator and levelling feet for accurate levelling of the balance



STANDARD FACTORY

IP 68 1 DAY **M**

STANDARD FACTORY

IP 68 2 DAYS **M**

STANDARD FACTORY

IP 68 2 DAYS **M**

| Model | Weighing capacity | Readability | Verification value | Minimal load | Cable length | Net weight | Weighing plate | Price excl. of VAT ex works € |
|--|-------------------|-------------|--------------------|--------------|--------------|---------------|----------------|-------------------------------|
| | [Max] kg | [d] g | [e] g | [Min] g | approx. m | approx. kg | W×D×H mm | |
| 10 Stainless steel platform KFP-V40 IP68 | | | | | | | | |
| KFP 6V40M | 6 | 0,5 | 1 2 | 20 | 3 | 5,0 | 300×240×104 | 900,- |
| KFP 15V40M | 15 | 1 | 2 5 | 40 | 3 | 5,0 | 300×240×104 | 900,- |
| KFP 15V40LM | 15 | 1 | 2 5 | 40 | 3 | 5,0 | 400×300×107 | 930,- |
| KFP 30V40M | 30 | 2 | 5 10 | 100 | 3 | 8 | 400×300×107 | 930,- |
| KFP 30V40LM | 30 | 2 | 5 10 | 100 | 3 | 8 | 500×400×107 | 1010,- |
| KFP 60V40M | 60 | 5 | 10 20 | 200 | 3 | 8 | 400×300×120 | 950,- |
| KFP 60V40LM | 60 | 5 | 10 20 | 200 | 3 | 10 | 500×400×124 | 1050,- |
| KFP 150V40M | 150 | 10 | 20 50 | 400 | 3 | 10 | 500×400×124 | 1050,- |
| KFP 150V40LM | 150 | 10 | 20 50 | 400 | 3 | 22 | 650×500×136 | 1330,- |
| KFP 300V40M | 300 | 20 | 50 100 | 1000 2000 | 3 | 22 | 650×500×136 | 1250,- |
| 11 Stainless steel weighing bridge KFP-V40 IP68 | | | | | | | | |
| KFP 3000V40M | 3000 | 1000 | 1000 | 20000 | 5 | 135 | 1500×1250×80 | 4000,- |
| 12 Stainless steel weighing bridge KFD-V40 IP68 | | | | | | | | |
| KFD 600V40M* | 600 | 200 | 200 | 4000 | 5 | 130 | 1600×1200×78 | 3840,- |
| KFD 1500V40M* | 1500 | 500 | 500 | 10000 | 5 | 130 | 1600×1220×95 | 3790,- |

! * ONLY WHILE STOCKS LAST!

13



LOAD CELLS

Accuracy classes with nominal loads from 300 g to 100 t and protection classes up to IP69K as well as cells protected according to ATEX or OIML approved cells are available to you from now in the SAUTER product range. Whatever the project – whether it's the development of customised weighing systems, installation in silos and storage tanks or in shelving for continuous inventory, for special application in mechanical engineering or in any type of test bench – SAUTER can offer you just the right load cell.

Of course, we can also supply you with the appropriate accessories such as load corners, pivot heads, display devices, junction boxes or the relevant calibration certificate at the same time.

Any special requests? Do you need special load cells, other capacities or cable lengths, individual force test benches or a special mount for your test item?

No problem, our product specialist for force-load cells Mr Stefan Herrmann is available at any time to help you further and will work with you to develop a customised concept for your application.



Everything about load cells
in the SAUTER catalogue 2025.



Stefan Herrmann
Product specialist
Load cells
Tel. +49 7433 9933-214
stefan.herrmann@kern-sohn.com

BALANCE MANUFACTURE

Load cell + Junction Box + KERN YKV

FORCE MEASUREMENT

Load cell + SAUTER FL + Software

BALANCE MANUFACTURE

Load cell + display device

BALANCE MANUFACTURE

Load cell + KERN YKV +
KERN Software BalanceConnection

BALANCE MANUFACTURE

Load cell + Junction Box
+ display device



SAUTER load cells – integration opportunities



CP P4 · CP Y4
Single-point load cell made from anodised aluminium

Technical data

- CP P4: Accuracy in accordance with OIML R60 C3
- CP Y4: Accuracy in accordance with OIML R60 C2
- CE and RoHS compliant
- Protection against dust and water splashes IP65 (in accordance with EN 60529)
- Aluminium, anodised
- Suitable for price-computing scales, bench scales, platform scales, etc.
- Maximum platform size: 200×200 mm
- Nominal sensitivity: 0,9 mV/V
- 4-wire connection
- Cable length approx. 0,4 m

CP P1 · CP Y1
Single-point load cell made from anodised aluminium

Technical data

- CP P1: Accuracy in accordance with OIML R60 C3
- CP Y1: Accuracy in accordance with OIML R60 C2
- CE and RoHS compliant
- Protection against dust and water splashes IP65 (in accordance with EN 60529)
- Aluminium, anodised
- Suitable for price-computing scales, bench scales, platform scales, etc.
- Maximum platform size: 250×350 mm
- Nominal sensitivity: 2 mV/V
- 4-wire connection
- Note: Version in accordance with OIML R60 C4 or C5 on request

CP P3
Single-point load cell made from anodised aluminium

Technical data

- Accuracy in accordance with OIML R60 C3
- CE and RoHS compliant
- Protection against dust and water splashes IP65 (in accordance with EN 60529)
- Aluminium, anodised
- Suitable for price-computing scales, bench scales, platform scales, etc.
- Maximum platform size: 350×400 mm
- Nominal sensitivity: 2 mV/V
- 4-wire connection
- Cable length approx. 3 m
- Note: Version in accordance with OIML R60 C4 or C5 on request

STANDARD: IP 65, 1 DAY
OPTION: DAkkS +3 DAYS, ISO +4 DAYS

STANDARD: IP 65, M, 1 DAY
OPTION: DAkkS +3 DAYS, ISO +4 DAYS
CP P1

STANDARD: IP 65, 1 DAY
OPTION: DAkkS +3 DAYS, ISO +4 DAYS

| Model | Nominal load kg | Price excl. of VAT ex works € |
|-------------|-----------------|-------------------------------|
| KERN | | |
| CP 300-0P4 | 0,3 | 65,- |
| CP 600-0P4 | 0,6 | 65,- |
| CP 300-0Y4 | 0,3 | 55,- |
| CP 1500-0Y4 | 1,5 | 55,- |
| CP 3000-0Y4 | 3 | 55,- |

| Model | Nominal load kg | Cable length m | Price excl. of VAT ex works € |
|--------------|-----------------|----------------|-------------------------------|
| KERN | | | |
| CP 3-3P1 | 3 | 0,4 | 60,- |
| CP 3-2-3P1 | 3 | 2 | 74,- |
| CP 5-3P1 | 5 | 0,4 | 60,- |
| CP 6-3P1 | 6 | 0,4 | 60,- |
| CP 8-3P1 | 8 | 0,4 | 60,- |
| CP 10-3P1 | 10 | 0,4 | 60,- |
| CP 10-3-3P1 | 10 | 3 | 78,- |
| CP 15-3P1 | 15 | 0,4 | 60,- |
| CP 15-3-3P1 | 15 | 3 | 78,- |
| CP 20-3P1 | 20 | 0,4 | 60,- |
| CP 30-3P1 | 30 | 0,4 | 60,- |
| CP 35-3P1 | 35 | 0,4 | 60,- |
| CP 35-3-3P1 | 35 | 3 | 78,- |
| CP 40-3P1 | 40 | 0,4 | 60,- |
| CP 50-3P1 | 50 | 0,4 | 60,- |
| CP 50-2-3P1 | 50 | 2 | 74,- |
| CP 3-2Y1 | 3 | 0,45 | 33,- |
| CP 5-2Y1 | 5 | 0,45 | 33,- |
| CP 10-2Y1 | 10 | 0,45 | 33,- |
| CP 15-2Y1 | 15 | 0,45 | 33,- |
| CP 20-2Y1 | 20 | 0,45 | 33,- |
| CP 30-2Y1 | 30 | 0,45 | 33,- |
| CP 100-3-3Y1 | 100 | 3 | 50,- |

New model

| Model | Nominal load kg | Price excl. of VAT ex works € |
|-------------|-----------------|-------------------------------|
| KERN | | |
| CP 30-3P3 | 30 | 76,- |
| CP 40-3P3 | 40 | 76,- |
| CP 50-3P3 | 50 | 76,- |
| CP 75-3P3 | 75 | 76,- |
| CP 100-3P3 | 100 | 77,- |

Tip: Further details and technical data sheet as well as an extensive range of accessories can be found at www.kern-sohn.com



CP P2
Single-point load cell
made of aluminium

Technical data

- Accuracy in accordance with OIML R60 C3
- RoHS compliant
- Protection against dust and water splashes IP65 (in accordance with EN 60529)
- Aluminium alloy, anodized
- Suitable for price computing scales, bench scales etc.
- Maximum platform size
CP P2, 100 – 300 kg: 400×400 mm
CP P2, 400 – 500 kg: 450×450 mm
- CP P2: 4-wire connection
- Nominal sensitivity: 2 mV/V
- Cable length
CP P2: 2 m
- Note: Version in accordance with OIML R60 C4 or C5 on request

CP P7
Single-Point load cell
made from stainless steel

Technical data

- Accuracy in accordance with OIML R60 C3
- RoHS compliant
- Protection against dust and water splashes IP67 (in accordance with EN 60529)
- Stainless steel
- Area of application: Mass as well as compressive force measurement in harsh environmental conditions
- Suitable for price computing scales, bench scales etc.
- Maximum platform size: 400×400 mm
- 6-wire connection
- Nominal sensitivity: 2 mV/V
- Cable length: 1 m
- Note: Version in accordance with OIML R60 C4 on request

CP P8
Single-point load cell
made of aluminium

Technical data

- Accuracy in accordance with OIML R60 C3
- RoHS compliant
- Protection against dust and water splashes IP65 (in accordance with EN 60529)
- Aluminium alloy, anodized
- Suitable for price computing scales, bench scales etc.
- Maximum platform size 600×600 mm
- 6-wire connection
- Nominal sensitivity: 2 mV/V
- Cable length 3 m
- Note: Version in accordance with OIML R60 C4 or C5 on request

Tip: Further details and technical data sheet as well as an extensive range of accessories can be found at www.kern-sohn.com

STANDARD OPTION

IP 65 1 DAY +3 DAYS +4 DAYS

STANDARD OPTION

IP 67 1 DAY +3 DAYS +4 DAYS

STANDARD OPTION

IP 65 1 DAY +3 DAYS +4 DAYS

| Model | Nominal load | Price excl. of VAT ex works |
|------------|--------------|-----------------------------|
| KERN | kg | € |
| CP 100-3P2 | 100 | 81,- |
| CP 150-3P2 | 150 | 81,- |
| CP 200-3P2 | 200 | 81,- |
| CP 300-3P2 | 300 | 81,- |
| CP 400-3P2 | 400 | 81,- |
| CP 500-3P2 | 500 | 81,- |

| Model | Nominal load | Price excl. of VAT ex works |
|------------|--------------|-----------------------------|
| KERN | kg | € |
| CP 30-3P7 | 30 | 270,- |
| CP 50-3P7 | 50 | 270,- |
| CP 75-3P7 | 75 | 270,- |
| CP 100-3P7 | 100 | 270,- |
| CP 150-3P7 | 150 | 270,- |

| Model | Nominal load | Price excl. of VAT ex works |
|------------|--------------|-----------------------------|
| KERN | kg | € |
| CP 50-3P8 | 50 | 123,- |
| CP 100-3P8 | 100 | 123,- |
| CP 150-3P8 | 150 | 123,- |
| CP 200-3P8 | 200 | 123,- |
| CP 250-3P8 | 250 | 123,- |
| CP 300-3P8 | 300 | 123,- |
| CP 500-3P8 | 500 | 123,- |
| CP 600-3P8 | 600 | 123,- |



CR Q1
Load cell made from stainless steel

Technical data

- Accuracy in accordance with OIML R60 C1
- RoHS compliant
- Protection against dust and water splashes IP68 (in accordance with EN 60529), hermetically encapsulated
- Stainless steel
- Area of application: Measuring mass as well as compressive force
- Suitable for vehicle scales, weigh hoppers, vehicle testing equipment, test stands
- Nominal sensitivity: 2 mV/V
- Cable length 10 m

Accessories

- Load corner, steel, galvanised, suitable for CR Q1
 - [Max] ≤ 10 t: SAUTER CE Q42901, € 265,-
 - [Max] ≥ 20 t: SAUTER CE Q42902, € 420,-
- Load corner, steel, stainless, suitable for CR Q1
 - [Max] ≤ 10 t: SAUTER CE RQ42901, € 475,-
 - [Max] ≥ 20 t: SAUTER CE RQ42902, € 810,-



STANDARD OPTION

IP 68 1 DAY ISO
+4 DAYS
[Max] ≤ 25 t/
250 kN

| Model | Nominal load | Price excl. of VAT ex works € |
|--------------|--------------|-------------------------------|
| KERN | | |
| CR 2500-1Q1 | 2,5 t/25 kN | 285,- |
| CR 5000-1Q1 | 5 t/50 kN | 285,- |
| CR 10000-1Q1 | 10 t/100 kN | 285,- |
| CR 20000-1Q1 | 20 t/200 kN | 560,- |
| CR 30000-1Q1 | 30 t/300 kN | 560,- |

CR P1
Load cell made from stainless steel

Technical data

- Accuracy in accordance with OIML R60 C3
- RoHS compliant
- Protection against dust and water splashes IP68 (in accordance with EN 60529), hermetically encapsulated
- Stainless steel
- Area of application: Measuring mass as well as compressive force
- Suitable for weighbridges, handing scales, silo scales and other types of balances, test stands, etc.
- Nominal sensitivity: 1 – 2 mV/V, depending on nominal load
- Cable length
 - [Max] ≤ 1000 kg: 3 m
 - [Max] ≥ 2000 kg: 6 m

Accessories

- Load corner for CR 1000-3P1, CR 250-3P1, CR 500-3P1, steel, incl. pressure piece, SAUTER CE P244011, € 600,-
- Pressure piece for CR 1000-3P1, CR 250-3P1, CR 500-3P1, steel, SAUTER CE P244012, € 115,-
- Load corner for CR 2000-3P1, steel, stainless incl. pressure piece, SAUTER CE P244021, € 720,-
- Pressure piece for CR 2000-3P1, steel, stainless, SAUTER CE P244022, € 125,-

STANDARD OPTION

IP 68 4 DAYS DAkkS ISO
+3 DAYS +4 DAYS
[Max] ≤ 500 kg/
5 kN

| Model | Nominal load | Price excl. of VAT ex works € |
|-------------|---------------|-------------------------------|
| KERN | | |
| CR 60-3P1 | 60 kg/0,6 kN | 930,- |
| CR 130-3P1 | 130 kg/1,3 kN | 980,- |
| CR 250-3P1 | 250 kg/2,5 kN | 890,- |
| CR 500-3P1 | 500 kg/5 kN | 860,- |
| CR 1000-3P1 | 1000 kg/10 kN | 860,- |
| CR 2000-3P1 | 2000 kg/20 kN | 860,- |

CR Y1
Load cell made from steel alloy

Technical data

- Accuracy in accordance with OIML R60 C1
- RoHS compliant
- High precision (comprehensive error 0,05 % F.S.)
- Protection against dust and water splashes IP68 (in accordance with EN 60529), hermetically encapsulated
- Stainless steel
- Area of application: for weight, tensile and compressive force measurement
- Suitable for weight measurement as well as force and force test stands
- Force transmission via pressure piece or threaded hole
- Nominal sensitivity: 2 mV/V
- Cable length: 3 m
- Pressure piece included with delivery
- Thread for pressure piece or other force application:
 - up to 5000 kg M16×1,5,
 - from 10000 kg M32×1,5

Tip: Further details and technical data sheet as well as an extensive range of accessories can be found at www.kern-sohn.com

STANDARD OPTION

IP 68 1 DAY DAkkS ISO
+3 DAYS +4 DAYS
[Max] ≤ 500 kg/
5 kN

| Model | Nominal load | Price excl. of VAT ex works € |
|--------------|--------------|-------------------------------|
| KERN | | |
| CR 500-1Y1 | 0,5 t/5 kN | 270,- |
| CR 1000-1Y1 | 1 t/10 kN | 270,- |
| CR 5000-1Y1 | 5 t/50 kN | 270,- |
| CR 10000-1Y1 | 10 t/100 kN | 430,- |
| CR 20000-1Y1 | 20 t/200 kN | 430,- |



CB Q1 · CB Q2

Bending beam and shear beam load cell made from stainless steel

Technical data

- Accuracy in accordance with OIML R60 C3
- CE and RoHS compliant
- Protection against dust and water splashes IP68/IP69K (in accordance with EN 60529), welded to create a hermetic seal
- Stainless steel
- Area of application: Measuring mass as well as compressive force in harsh environments
- Suitable for platform scales, weigh hoppers, floor scales and other weighing devices
- 4-wire connection
- Nominal sensitivity: 2 mV/V
- Cable length: 3 m
- Note: Accuracy class OIML R60 C6 or EX version on request



| | | | | |
|----------------|--------|-------|---------|---------|
| STANDARD | | | OPTION | |
| | | | | |
| IP 68 | IP 69K | 1 DAY | +3 DAYS | +4 DAYS |
| [Max] ≤ 500 kg | | | | |

| Model | Nominal load kg | Price excl. of VAT ex works € |
|--------------|--------------------|--|
| KERN | | |
| CB 5-3Q1 | 5 | 230,- |
| CB 10-3Q1 | 10 | 230,- |
| CB 20-3Q1 | 20 | 230,- |
| CB 30-3Q1 | 30 | 230,- |
| CB 50-3Q1 | 50 | 230,- |
| CB 75-3Q1 | 75 | 230,- |
| CB 100-3Q1 | 100 | 230,- |
| CB 150-3Q1 | 150 | 230,- |
| CB 200-3Q1 | 200 | 230,- |
| CB 250-3Q1 | 250 | 230,- |
| CB 300-3Q1 | 300 | 230,- |
| CB 500-3Q1 | 500 | 230,- |
| CB 750-3Q2* | 750 | 240,- |
| CB 1000-3Q2* | 1000 | 240,- |
| CB 1500-3Q2* | 1500 | 240,- |

1 * ONLY WHILE STOCKS LAST

CB P1

Bending beams made from stainless steel

Technical data

- Accuracy in accordance with OIML R60 C3
- CE and RoHS compliant
- Protection against dust and water splashes IP67 (in accordance with EN 60529), hermetically encapsulated
- Nickel-plated steel
- Area of application: Measuring mass as well as compressive force in harsh environments
- Suitable for platform scales, silo scales, bed scales and other types of scales
- 4-wire connection
- Nominal sensitivity: 3 mV/V
- Cable length: 3 m



| | | | | |
|----------|---|-------|---------|---------|
| STANDARD | | | OPTION | |
| | | | | |
| IP 67 | M | 1 DAY | +3 DAYS | +4 DAYS |

| Model | Nominal load kg | Price excl. of VAT ex works € |
|------------|--------------------|--|
| KERN | | |
| CB 100-3P1 | 100 | 114,- |
| CB 250-3P1 | 250 | 114,- |

Accessories CB Q1 · CB Q2

- Traction device, steel, galvanised, suitable for CB Q1, SAUTER CE Q30901, € 85,-
- Traction device, steel, stainless, suitable for CB Q2, SAUTER CE Q34905, € 90,-
- **1** Base plate, steel, galvanised, suitable for CB Q1, SAUTER CE Q30903, € 100,-
- Base plate, steel, stainless, suitable for CB Q1, SAUTER CE RQ30903, € 190,-
- Base plate, steel, stainless, suitable for CB Q2, SAUTER CE Q34903, € 95,-
- **1** Bearing, steel, stainless, suitable for CB Q1 5 – 50 kg, SAUTER CE Q30904, € 120,- 75 – 300 kg, SAUTER CE Q30905, € 120,- CB 500-3Q1, SAUTER CE Q30906, € 205,-
- Bearing, steel, stainless, suitable for CB Q2, SAUTER CE Q34906, € 190,-
- Load corner, steel, stainless, suitable for CB Q1, SAUTER CE RQ30907, € 315,-
- Adjustable foot, steel, stainless, suitable for CB Q2, SAUTER CE Q34901, € 70,-

Accessories CB P1

- Adjustable foot, steel, nickel-plated, M12 thread, suitable for CB P1, SAUTER CE P2012, € 27,-
- **2** Load corner, steel, nickel-plated, suitable for CB P1, SAUTER CE P4022, € 195,-
- Distance plate for bending beams CB P1 made from steel, SAUTER CE P3012, € 9,-



CT Q1 Shear beam made from stainless steel

Technical data

- Accuracy in accordance with OIML R60 C3
- CE and RoHS compliant
- Protection against dust and water splashes IP68/IP69K (in accordance with EN 60529), welded to create a hermetic seal
- Stainless steel
- Area of application: Measuring mass as well as compressive force in harsh environments
- Suitable for platform scales, weigh hoppers, flush-mounted floor scales and other weighing devices
- 6-wire connection
- Nominal sensitivity: 2 mV/V
- Cable length: 5 m
- Note: EX version on request



STANDARD

IP 68 IP 69K 1 DAY

OPTION

DAkkS +3 DAYS ISO +4 DAYS

[Max] ≤ 500 kg

| Model | Nominal load kg | Price excl. of VAT ex works € |
|--------------|--------------------|--|
| KERN | | |
| CT 300-3Q1 | 300 | 220,- |
| CT 500-3Q1 | 500 | 220,- |
| CT 750-3Q1 | 750 | 220,- |
| CT 1000-3Q1 | 1000 | 220,- |
| CT 1500-3Q1 | 1500 | 220,- |
| CT 2000-3Q1 | 2000 | 220,- |
| CT 3000-3Q1 | 3000 | 435,- |
| CT 5000-3Q1 | 5000 | 435,- |
| CT 7500-3Q1 | 7500 | 570,- |
| CT 10000-3Q1 | 10000 | 570,- |

CT P1 · CT P2 Shear beam made from stainless steel

Technical data

- Accuracy in accordance with OIML R60 C3
- CE and RoHS compliant
- Protection against dust and water splashes IP67 (in accordance with EN 60529), welded to create a hermetic seal
- Nickel-plated steel
- Area of application: Measuring mass as well as compressive force in harsh environments
- Suitable for platform scales, weigh hoppers, flush-mounted floor scales and other weighing devices
- 4-wire connection
- Nominal sensitivity: 3 mV/V
- Cable length
[Max] ≤ 1000 kg: 4 m
[Max] ≥ 1500 kg: 6 m
- CT P2: Delivery with calibrated sensitivity, when ordering several cells



STANDARD

IP 67 M 1 DAY

OPTION

DAkkS +3 DAYS ISO +4 DAYS

[Max] ≤ 500 kg

| Model | Nominal load kg | Price excl. of VAT ex works € |
|--------------|--------------------|--|
| KERN | | |
| CT 500-3P1 | 500 | 98,- |
| CT 1000-3P1 | 1000 | 98,- |
| CT 1500-3P1 | 1500 | 98,- |
| CT 2500-3P1 | 2500 | 119,- |
| CT 3000-3P1 | 3000 | 119,- |
| CT 5000-3P1 | 5000 | 119,- |
| CT 10000-3P1 | 10000 | 173,- |
| CT 500-3P2 | 500 | 103,- |
| CT 1000-3P2 | 1000 | 103,- |
| CT 5000-3P2 | 5000 | 124,- |
| CT 3000-3P2 | 3000 | 125,- |
| CT 10000-3P2 | 10000 | 178,- |

Accessories CT Q1

- Base plate, steel, stainless, suitable for CT Q1: SAUTER CE RQ35911, € 200,-
- CT 3000-3Q1, CT 5000-3Q1: SAUTER CE RQ35912, € 200,-
- CT 7500-3Q1, CT 10000-3Q1: SAUTER CE RQ35919, € 860,-
- Bearing, steel, stainless, suitable for CT Q1: SAUTER CE RQ35909, € 165,-
- CT 3000-3Q1, CT 5000-3Q1: SAUTER CE RQ35910, € 320,-
- CT 7500-3Q1, CT 10000-3Q1: SAUTER CE RQ35918, € 390,-
- Load corner, steel, stainless, suitable for CT Q1: SAUTER CE RQ35902, € 420,-
- Load corner, steel, stainless, suitable for CT 3000-3Q1, CT 5000-3Q1, SAUTER CE RQ35903, € 620,-

Accessories CT P1 · CT P2

- Load corner, steel, stainless, suitable for CT 10000-3P1, CT 10000-3P2, SAUTER CE P40210, € 510,-
- Load corner, steel, nickel-plated, suitable for CT 500-3P1, CT 1000-3P1, CT 1500-3P1, SAUTER CE P4022, € 195,-
- Load corner, steel, nickel-plated, suitable for CT 2500-3P1, CT 3000-3P1, CT 5000-3P1, SAUTER CE P4025, € 260,-
- Adjustable foot, steel, nickel-plated, M12 thread, suitable for CT 500-3P1, CT 1000-3P1, CT 1500-3P1, SAUTER CE P2012, € 27,-
- Adjustable foot, steel, nickel-plated, M18 thread, suitable for CT 2500-3P1, CT 3000-3P1, CT 5000-3P1, SAUTER CE P2018, € 38,-
- Adjustable foot, steel, nickel-plated, M24 thread, suitable for CT 10000-3P1, SAUTER CE P2024, € 113,-
- Distance plate, suitable for CT 500-3P1, CT 500-3P2, CT 1000-3P1, CT 1000-3P2, CT 1500-3P1: SAUTER CE P3012, € 9,-
- CT 2500-3P1, CT 3000-3P1, CT 3000-3P2, CT 5000-3P1, CT 5000-3P2: SAUTER CE P3015, € 10,-
- CT 10000-3P1, CT 10000-3P2: SAUTER CE P30110, € 27,-

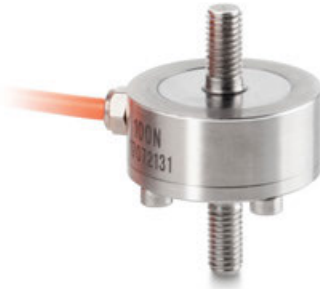

CO Y1
Miniature cylindrical load cell
made from stainless steel

Technical data

- Accuracy in accordance with OIML G5
- High precision (comprehensive Error 0,5 % F.S.)
- RoHS compliant
- Protection against dust and water splashes IP65
- Area of application: Compressive applications
- Suitable for weight measurement as well as force and force test stands
- Nominal sensitivity: 1,0 – 1,5 mV/V, depending on nominal load
- Cable length: 2 m

CO Y2
Miniature cylindrical load cell
made from stainless steel

Technical data

- Accuracy in accordance with OIML G5
- High level of accuracy (Comprehensive error 0,5 % F. S.)
- RoHS compliant
- Protection against dust and water splashes IP65
- Area of application: Tensile and compressive applications
- Suitable for weight measurement as well as force and force test stands
- Nominal sensitivity: 1,5 – 2 mV/V, depending on nominal load
- Cable length: 2 m

CO Y5
Tension and compression force measuring cell made from stainless steel

Technical data

- Accuracy in accordance with OIML R60 G1
- CE and RoHS compliant
- Protection against dust and water splashes IP66 (in accordance with EN 60529)
- Stainless steel
- Very low design
- Suitable for test stands, force gauges, automation systems, etc.
- 4-wire connection
- Nominal sensitivity:
CO 0.5-Y5, CO 1-Y5: 1 mV/V
CO 5-Y5, CO 10-Y5: 2 mV/V
- Cable length: 2 m

Tip: Further details and technical data sheet as well as an extensive range of accessories can be found at www.kern-sohn.com

STANDARD OPTION

IP 65 1 DAY DAKkS ISO
+3 DAYS +4 DAYS

[Max] ≤ 500 kg/ 5 kN

STANDARD OPTION

IP 65 1 DAY DAKkS ISO
+3 DAYS +4 DAYS

[Max] ≤ 500 kg/ 5 kN

STANDARD OPTION

IP 66 1 DAY DAKkS ISO
+3 DAYS +4 DAYS

[Max] ≥ 1 kg/ 10 N

| Model | Nominal load | Price excl. of VAT ex works € |
|-------------|---------------|-------------------------------|
| KERN | | |
| CO 10-Y1 | 10 kg/100 N | 170,- |
| CO 20-Y1 | 20 kg/200 N | 170,- |
| CO 50-Y1 | 50 kg/500 N | 170,- |
| CO 100-Y1 | 100 kg/1 kN | 170,- |
| CO 200-Y1 | 200 kg/2 kN | 170,- |
| CO 500-Y1 | 500 kg/5 kN | 200,- |
| CO 1000-Y1 | 1000 kg/10 kN | 200,- |
| CO 2000-Y1 | 2000 kg/20 kN | 235,- |

| Model | Nominal load | Price excl. of VAT ex works € |
|-------------|---------------|-------------------------------|
| KERN | | |
| CO 10-Y2 | 10 kg/100 N | 250,- |
| CO 20-Y2 | 20 kg/200 N | 250,- |
| CO 50-Y2 | 50 kg/500 N | 250,- |
| CO 100-Y2 | 100 kg/1 kN | 310,- |
| CO 200-Y2 | 200 kg/2 kN | 310,- |
| CO 500-Y2 | 500 kg/5 kN | 310,- |
| CO 1000-Y2 | 1000 kg/10 kN | 310,- |
| CO 2000-Y2 | 2000 kg/20 kN | 345,- |

| Model | Nominal load | Price excl. of VAT ex works € |
|-------------|--------------|-------------------------------|
| KERN | | |
| CO 0.5-Y5 | 500 g/5 N | 365,- |
| CO 1-Y5 | 1 kg/10 N | 365,- |
| CO 5-Y5 | 5 kg/50 N | 365,- |
| CO 10-Y5 | 10 kg/100 N | 365,- |



CJ P4



CJ P4PG



CJ X467



CJ X468

CJ P

Junction box for the connection of several measuring cells to an evaluation unit

Features

- Prepared for 4-wire and 6-wire measuring cells
- The robust aluminium diecast housing
- Protection against dust and water splashes IP65

CJ X

Junction box for the connection of several measuring cells to an evaluation unit

Features

- Prepared for 4-wire and 6-wire measuring cells

CJ X467

- Robust housing made of stainless steel with IP67 dust and spray protection

CJ X468

- The robust aluminium diecast housing, protection against dust and water splashes IP68

Tip: Further details and technical data sheet as well as an extensive range of accessories can be found at www.kern-sohn.com

STANDARD



| Model | Number of connection options | Price excl. of VAT ex works € |
|-------------|------------------------------|-------------------------------|
| KERN | | |
| CJ P2 | 2 | 87,- |
| CJ P4 | 4 | 87,- |
| CJ P4PG | 4 | 98,- |

STANDARD

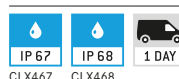

| Model | Number of connection options | Price excl. of VAT ex works € |
|-------------|------------------------------|-------------------------------|
| KERN | | |
| CJ X467 | 4 | 220,- |
| CJ X468 | 4 | 130,- |

14



PALLET TRUCK SCALES

Weighing and transporting – just one operation

Speed up your warehouse and dispatch processes with the KERN pallet truck scales.

Get the exact weight of a load and at the same time, transport it to a specific location, all in one operation. This reduces commissioning times and avoids queues in front of fixed floor scales.

These mobile weighing solutions are space-saving and deliver reliable weighing results. Differences between given and actual weights can be determined quickly e.g. in the goods-in and out department. This uncovers inaccurate quantities, saves time and money and therefore ensures a very short amortisation period of the scales original cost.

KERN pallet truck scales are of robust industrial quality, with high-level protection against dust and water splashes, with high-contrast, easy-to-read displays as well as solid wheels and load rollers – all this helps to give you practical support in your work – day after day.

Of course, all KERN pallet truck scales can also be calibrated and delivered with a DAkkS calibration certificate (optional). This ensures the high level of accuracy of your pallet truck scale.

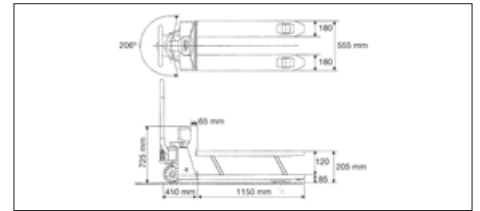
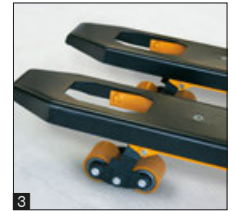
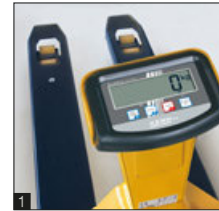

Pallet truck scale with complete protection against dust and water splashes IP65/67 and a memory for a container weight

Features

- PRE-TARE function for manual subtraction of a known container weight, useful for checking fill-levels
- **1** Display device: Plastic, protected against dust and water splashes IP65
- **2** Load fork: Protection against dust and water splashes IP67, temporary use in wet areas possible
- Pivot range 206°
- Castors: Solid rubber on aluminium rims
- **3** Load rollers: Tandem tyres to overcome thresholds and obstacles more easily
- Summation of weight values

Technical data

- Large LCD display, digit height 28 mm
- Ready for use: Batteries standard, 4×1.5 V AA, operating time approx. 80 h
- Permissible ambient temperature -10 °C/40 °C

Accessories

- **4** Castors made of polyurethane on aluminium rims. Ideal for light-coloured flooring as they leave less visible abrasive marks. Suitable for the current models of the pallet truck scale range KERN VHB (when retrofitting, please give the serial number of the pallet truck scale available when ordering), scope of delivery: 1 item, KERN VHB-A02, € 140,-

Note: Shipment via freight forwarder. Please ask for dimensions, gross weight, shipping costs

STANDARD



OPTION



| Model | Weighing capacity [Max] kg | Readability [d] kg | Linearity kg | Net weight approx. kg | Price excl. of VAT ex works € | Options | |
|-----------------|----------------------------------|--------------------------|-----------------|-----------------------------|--|---------------------------|-------|
| | | | | | | DAkKS Calibr. Certificate | € |
| KERN VHB 2T1 | 2000 | 1 | ± 2 | 110 | 1930,- | 963-131 | 290,- |



2025's MOST WANTED!

Most wanted and highly coveted: Discover the future of weighing and measuring technology with more than 5000 high-quality products. The new KERN product catalogues 2025 are available in five languages!

BALANCES AND TEST SERVICE

Get a full overview of the wide range from KERN, including our high-quality balances, test weights and services such as verification and calibration services.

MEDICAL SCALES

Our medical scales cover the full array: baby scales to personal scales, chair scales and adiposity scales through to hand grip dynamometers, pharmaceutical balances and veterinary scales, we offer the complete range.

MICROSCOPES AND REFRACTOMETERS

Discover our large range of optical instruments, such as, for example our compound, polarisation or fluorescence microscopes, or our analogue and digital refractometers.

SAUTER MEASURING TECHNOLOGY

From force-measuring devices through to hardness measuring equipment and on to measuring cells - you can find everything you need for accurate, reliable measurements.

TEST SERVICE BROCHURE

Detailed information on all topics pertaining to the calibration and conformity assessment of balances, test weights and measuring devices.

All catalogues and information material are available for you to download as PDF files from our website: www.kern-sohn.com/shop/en/DOWNLOADS



15



HANGING SCALES, CRANE SCALES

TÜV-tested safety

KERN puts great emphasis on safety. For your safety, all KERN hanging and crane scales are subject to a stringent load test in accordance with EN 13155 and (Non-fixed load lifting attachments/breakage resistance) and EN 61010-1 (Electrical safety).

As well as the classic crane scales, we also have electronic tensile dynamometers which are extremely versatile thanks to their stable, compact construction. They can, for example, be fitted into testing machines, used for checking for overload, for bracing and tensile force measurement, etc.

This type of device is ideally suited for use between shackles or with a test bench. This is where the benefit of this construction comes to the fore, as the tensile force can be applied in both directions. These compact crane scales are also particularly suitable when weighing suspended loads where space is tight.

At the core of this construction is a robust load cell. Through the absence of moving parts, these scales are practical in maintenance and wear free.

Note: DAkkS calibration and conformity evaluation for crane scales up to 12 t



Do you use your crane scales in ISO-certified processes or where verification is mandatory? Then we can produce the right calibration certificate or the relevant Declaration of Conformity for your measuring device. Thanks to a modern crane scale test unit, we can calibrate or verify crane scales and force-measuring devices from any manufacturer to a maximum load of up to 12 t or 120 kN. All the important details see DAkkS Calibration Service or directly from one of our test service specialists, we will be pleased to help you.

Quick-Finder Hanging Scales/Crane Scales

| Readout | Weighing range [Max] kg | Model | Price excl. of VAT ex works € | Page | | | | | | |
|------------------|-------------------------|---------------|-------------------------------|------|--|---|---|--|---|---|
| [d] kg | kg | KERN | € | | For an explanation on the pictos, see the front flap | | | | | |
| 0,005 | 5 | HDB 5K5N | 62,- | 166 | ● | ● | ● | | | |
| 0,005 | 6 | HDB 6K-3XL | 82,- | 166 | ● | ● | ● | | | |
| 0,01 | 10 | HDB 10K10N | 62,- | 166 | ● | ● | ● | | | |
| 0,01 | 15 | HDB 10K-2XL | 82,- | 166 | ● | ● | ● | | | |
| 0,01 | 20 | HCB 20K10 | 115,- | 167 | ● | ● | ● | | | |
| 0,02 | 15 | CH 15K20 | 72,- | 165 | ● | ● | ● | | | |
| 0,02 | 30 | HDB 30K-2XL | 82,- | 166 | ● | ● | ● | | | |
| 0,02 | 50 | HCB 50K20 | 125,- | 167 | ● | ● | ● | | | |
| 0,02 | 60 | HCD 60K-2 | 200,- | 169 | ● | ● | ● | | ○ | |
| 0,02 0,05 | 60 150 | HCD 100K-2D | 210,- | 169 | ● | ● | ● | | ○ | |
| 0,05 | 50 | CH 50K50 | 78,- | 165 | ● | ● | ● | | | |
| 0,05 | 99 | HCB 99K50 | 105,- | 167 | ● | ● | ● | | | |
| 0,05 | 150 | HCD 100K-2 | 200,- | 169 | ● | ● | ● | | ○ | |
| 0,05 0,1 | 150 300 | HCD 300K-2D | 210,- | 169 | ● | ● | ● | | ○ | |
| 0,05 0,1 0,2 | 150 300 600 | HFD 600K-1 | 480,- | 172 | ● | | | | | ● |
| 0,05 0,1 0,2 | 150 300 600 | HFD 600K-1IP | 590,- | 172 | ● | | ● | | | ● |
| 0,1 | 50 | CH 50K100 | 68,- | 165 | ● | ● | ● | | | |
| 0,1 | 50 | HCB 50K100 | 95,- | 167 | ● | ● | ● | | | |
| 0,1 | 50 | HCN 50K100IP | 145,- | 168 | ● | ● | ● | | | |
| 0,1 | 200 | HCB 200K100 | 125,- | 167 | ● | ● | ● | | | |
| 0,1 | 300 | HCD 300K-1 | 200,- | 169 | ● | ● | ● | | | ○ |
| 0,1 | 1000 | HFM 1T0.1 | 1010,- | 174 | ● | | | | | ● |
| 0,1 0,2 0,5 | 300 600 1500 | HFD 1T-4 | 490,- | 172 | ● | | | | | ● |
| 0,1 0,2 0,5 | 300 600 1500 | HFD 1T-4IP | 600,- | 172 | ● | | ● | | | ● |
| 0,2 | 100 | HCB 100K200 | 105,- | 167 | ● | ● | ● | | | |
| 0,2 | 100 | HCN 100K200IP | 145,- | 168 | ● | ● | ● | | | |
| 0,2 | 600 | HFA 600K-1 | 680,- | 170 | ● | | ● | | | ● |
| 0,2 | 600 | HFC 600K-1 | 1070,- | 171 | ● | | ● | | | ● |
| 0,2 | 600 | HFD 600K-1M | 650,- | 172 | ○ | ● | | | | ● |
| 0,2 0,5 1 | 600 1500 3000 | HFD 3T-3 | 670,- | 172 | ● | | | | | ● |
| 0,2 0,5 1 | 600 1500 3000 | HFD 3T-3IP | 740,- | 172 | ● | | ● | | | ● |
| 0,5 | 200 | HCB 200K500 | 100,- | 167 | ● | ● | ● | | | |
| 0,5 | 200 | HCN 200K500IP | 145,- | 168 | ● | ● | ● | | | |
| 0,5 | 1000 | HFA 1T-4 | 680,- | 170 | ● | | ● | | | ● |
| 0,5 | 1000 | HFC 1T-4 | 1070,- | 171 | ● | | ● | | | ● |
| 0,5 | 1500 | HFD 1T-4M | 660,- | 172 | ○ | ● | | | | ● |
| 0,5 | 3000 | HFM 3T0.5 | 1040,- | 174 | ● | | | | | ● |
| 0,5 | 5000 | HFM 5T0.5 | 1400,- | 174 | ● | | | | | ● |
| 0,5 1 2 | 1500 3000 6000 | HFD 6T-3 | 850,- | 172 | ● | | | | | ● |
| 0,5 1 2 | 1500 3000 6000 | HFD 6T-3IP | 920,- | 172 | ● | | ● | | | ● |
| 1 | 500 | HCB 0.5T-3 | 205,- | 167 | ● | ● | ● | | | |
| 1 | 3000 | HFA 3T-3 | 740,- | 170 | ● | | ● | | | ● |
| 1 | 3000 | HFC 3T-3 | 1140,- | 171 | ● | | ● | | | ● |
| 1 | 3000 | HFD 3T-3M | 860,- | 172 | ○ | ● | | | | ● |
| 1 | 10000 | HFM 10T1 | 1860,- | 174 | ● | | | | | ● |
| 1 2 5 | 3000 6000 12000 | HFD 10T-3 | 990,- | 172 | ● | | | | | ● |
| 1 2 5 | 3000 6000 12000 | HFD 10T-3IP | 1060,- | 172 | ● | | ● | | | ● |
| 2 | 1000 | HCB 1T-3 | 265,- | 167 | ● | ● | ● | | | |
| 2 | 5000 | HFA 5T-3 | 820,- | 170 | ● | | ● | | | ● |
| 2 | 5000 | HFC 5T-3 | 1220,- | 171 | ● | | ● | | | ● |
| 2 | 6000 | HFD 6T-3M | 1050,- | 172 | ○ | ● | | | | ● |
| 5 | 10000 | HFA 10T-3 | 1290,- | 170 | ● | | ● | | | ● |
| 5 | 10000 | HFC 10T-3 | 1690,- | 171 | ● | | ● | | | ● |
| 5 | 12000 | HFD 10T-3M | 1200,- | 172 | ○ | ● | | | | ● |

● Standard ○ Option



The classic among manual hanging scales – perfect for rapid weighing of higher loads

Features

- **1** With the TÜV certification mark, the scales meet the requirements of the standard EN 13155 (Non-fixed load lifting attachments/ Breakage resistance) and EN 61010-1 (Electrical safety)
- Ideal for rapid control in goods-in and goods-out
- Also essential in the private sector to determine the weight of fish, game, fruits, bicycle parts, suitcases etc.
- Hold function: For easy reading of the weighing result, the display can be “frozen” in different ways. Either automatically when the weighing value remains unchanged or manually by pressing the Hold key
- Peak load display (peak hold)
- Hook made of steel

Technical data

- LCD display, digit height 11 mm
- **2** Tape measure, extractable, length approx. 100 cm
- Ready for use: Batteries included, 9 V block, operating time up to 20 h
- Weighing units: kg, lb, N
- Overall dimensions W×D×H 90×30×283 mm
- Net weight approx. 0,35 kg
- Permissible ambient temperature 5 °C/35 °C

Accessories

- **3** Tare pan with pan beam, max. load 30 kg, details see *Accessories*, KERN CH-A01N, € 88,-

STANDARD



OPTION



| Model | Weighing capacity | Readability | Price excl. of VAT ex works € | Options | |
|-----------|-------------------|-------------|--|---------------|--------------------------|
| | | | | DAKkS KERN | Calibr. Certificate € |
| KERN | [Max] kg | [d] g | | | |
| CH 15K20 | 15 | 20 | 72,- | 963-128H | 124,- |
| CH 50K50 | 50 | 50 | 78,- | 963-128H | 124,- |
| CH 50K100 | 50 | 100 | 68,- | 963-128H | 124,- |



User-friendly hanging scale for rapid, mobile weighing

Features

- **1** With the TÜV certification mark, the scales meet the requirements of the standard EN 13155 (Non-fixed load lifting attachments/ Breakage resistance) and EN 61010-1 (Electrical safety)
- HDB-XL: High-capacity XL-version. The larger design creates space for a large handle, which enables even better handling especially with heavier loads
- Ideal for rapid control in goods-in and goods-out
- Also essential in the private sector to determine the weight of fish, game, fruits, bicycle parts, suitcases etc.
- Hold function: For easy reading of the weighing result, the display can be “frozen” in different ways. Either automatically when the weighing value remains unchanged or manually by pressing the Hold key
- Hook, steel, included with the delivery. Can be hinged on HDB-N models
- Peak load display (peak hold)

Technical data

- LCD display, digit height 12 mm
- Ready for use: Batteries included, 2×1.5 V AAA, operating time up to 180 h
- Weighing units: kg, lb, N
- Permissible ambient temperature 5 °C/35 °C

Accessories

- **2** Tare pan with pan beam, max. load 30 kg, details see *Accessories*, KERN CH-A01N, € 88,-

15



| Model | Weighing capacity [Max] kg | Readability [d] g | Dimensions W×D×H mm | Net weight approx. kg | Price excl. of VAT ex works € | Options | |
|--------------------------|----------------------------------|-------------------------|---------------------------|-----------------------------|--|---------------|--------------------------|
| | | | | | | DAkKS KERN | Calibr. Certificate € |
| KERN | | | | | | | |
| HDB 5K5N | 5 | 5 | 72×25×188 | 0,20 | 62,- | 963-127H | 103,- |
| HDB 10K10N | 10 | 10 | 72×25×188 | 0,20 | 62,- | 963-128H | 124,- |
| High-capacity XL-version | | | | | | | |
| HDB 6K-3XL* | 6 | 5 | 101×25×203 | 0,25 | 82,- | 963-128H | 124,- |
| HDB 10K-2XL | 15 | 10 | 101×25×203 | 0,25 | 82,- | 963-128H | 124,- |
| HDB 30K-2XL | 30 | 20 | 101×25×211 | 0,25 | 82,- | 963-128H | 124,- |

1 * ONLY WHILE STOCKS LAST



Handy hanging scale for higher loads

Features

- **1** With the TÜV certification mark, the scales meet the requirements of the standard EN 13155 (Non-fixed load lifting attachments/ Breakage resistance) and EN 61010-1 (Electrical safety)
- Ideal for rapid control in goods-in and goods-out
- Also essential in the private sector to determine the weight of fish, game, fruits, bicycle parts, suitcases etc.
- Hold function: For easy reading of the weighing result, the display can be "frozen" in different ways. Either automatically when the weighing value remains unchanged or manually by pressing the Hold key
- Peak load display (peak hold), Measuring frequency 5 Hz
- [Max] ≤ 200 kg: Snap link (stainless steel) with safety catch and hook (stainless steel) as standard, see larger picture

- **2** [Max] ≥ 500 kg: Reinforced version for heavy loads. Snap link and hook not included, see *Accessories*

Technical data

- LCD display, digit height 12 mm
- Hole diameter of load support, model with [Max] ≤ 200 kg: approx. 14 mm
- [Max] ≥ 500 kg: approx. 16 mm
- Weighing units: kg, lb, N
- Ready for use: Batteries included, 3×1.5 V AA, operating time up to 300 h
- Permissible ambient temperature 5 °C/35 °C

Accessories

Suitable for all models

- **3** Hook with safety catch, galvanised and lacquered cast steel, not rotatable, scope of delivery: 2 shackles, 1 connecting link, 1 hook, KERN YHA-06, € 140,-
- **4** High-strength shackle, hot-dipped galvanised cast steel bracket, curved edge. Scope of delivery: 2 shackles, KERN YSC-04, € 60,-

Suitable for all models with [Max] ≤ 200 kg

- Snap link (stainless steel) with safety catch, opening approx. 13 mm, KERN HCB-A01, € 35,-
- Hook (stainless steel), opening approx. 29 mm, KERN HCB-A02, € 35,-

Suitable for model HCB 20K10

- **5** Tare pan with pan beam, max. load 30 kg, details see *Accessories*, KERN CH-A01N, € 88,-

STANDARD



OPTION



| Model | Weighing capacity [Max] kg | Readability [d] g | Dimensions housing W×D×H mm | Net weight approx. kg | Price excl. of VAT ex works € | Options | |
|------------------|----------------------------------|-------------------------|--------------------------------------|-----------------------------|--|---------------|--------------------------|
| | | | | | | DAKKS KERN | Calibr. Certificate € |
| KERN HCB 20K10 | 20 | 10 | 82×43×153 | 0,30 | 115,- | 963-128H | 124,- |
| KERN HCB 50K20 | 50 | 20 | 82×43×153 | 0,30 | 125,- | 963-128H | 124,- |
| KERN HCB 99K50 | 99 | 50 | 82×43×153 | 0,30 | 105,- | 963-129H | 145,- |
| KERN HCB 50K100 | 50 | 100 | 82×43×153 | 0,30 | 95,- | 963-128H | 124,- |
| KERN HCB 200K100 | 200 | 100 | 82×43×153 | 0,30 | 125,- | 963-129H | 145,- |
| KERN HCB 100K200 | 100 | 200 | 82×43×153 | 0,30 | 105,- | 963-129H | 145,- |
| KERN HCB 200K500 | 200 | 500 | 82×43×153 | 0,30 | 100,- | 963-129H | 145,- |
| KERN HCB 0.5T-3 | 500 | 1000 | 82×43×153 | 0,40 | 205,- | 963-130H | 255,- |
| KERN HCB 1T-3 | 1000 | 2000 | 82×48×153 | 0,60 | 265,- | 963-130H | 255,- |



Robust, compact hanging scale with high level of protection against dust and water spray

Features

- **1** With the TÜV certification mark, the scales meet the requirements of the standard EN 13155 (Non-fixed load lifting attachments/ Breakage resistance) and EN 61010-1 (Electrical safety)
- **2** Housing stainless steel, IP65-protected against dust and water splashes
- Ideal for rapid control in goods-in and goods-out
- Also essential in the private sector to determine the weight of fish, game, fruits, bicycle parts, suitcases etc.
- Hold function: For easy reading of the weighing result, the display can be “frozen” in different ways. Either automatically when the weighing value remains unchanged or manually by pressing the Hold key
- Peak load display (peak hold)
- Internal measuring frequency: 5 Hz
- Snap link (stainless steel) with safety catch as standard
- Hook (stainless steel) as standard

Technical data

- LCD display, digit height 12 mm
- **3** Second display on the back of the balance, see larger picture
- Hole diameter of load support ca. 14 mm
- Ready for use: Batteries included, 2×1.5 V AA, operating time up to 200 h
- Weighing units: kg, lb, N
- Overall dimensions W×D×H 96×48×179 mm
- Net weight approx. 0,50 kg
- Permissible ambient temperature 5 °C/35 °C

Accessories

- Snap link (stainless steel) with safety catch, opening approx. 13 mm, KERN HCB-A01, € 35,-
- Hook (stainless steel), opening approx. 29 mm, KERN HCB-A02, € 35,-

15

| STANDARD | | | | | | | OPTION |
|----------|--|--|--|--|--|--|--------|
| | | | | | | | |

| Model | Weighing capacity [Max] kg | Readability [d] g | Price excl. of VAT ex works € | Options | |
|--------------------|----------------------------------|-------------------------|--|---------------|--------------------------|
| | | | | DAkkS KERN | Calibr. Certificate € |
| KERN HCN 50K100IP | 50 | 100 | 145,- | 963-128H | 124,- |
| KERN HCN 100K200IP | 100 | 200 | 145,- | 963-129H | 145,- |
| KERN HCN 200K500IP | 200 | 500 | 145,- | 963-129H | 145,- |

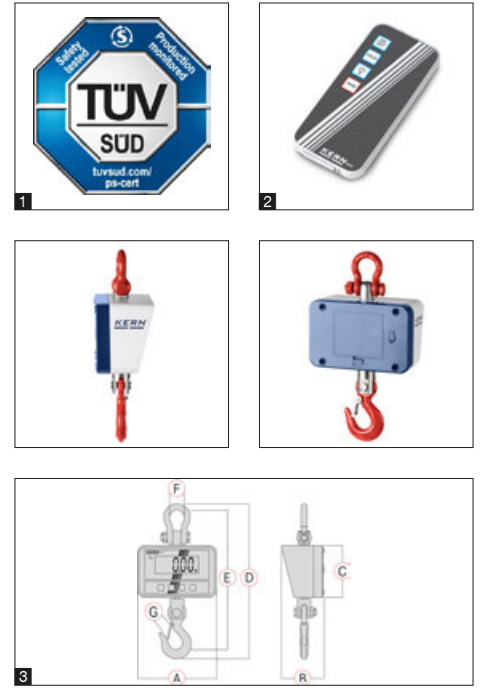

High-resolution crane scale for loads up to 300 kg

Features

- **1** With the TÜV certification mark, the scales meet the requirements of the standard EN 13155 (Non-fixed load lifting attachments/ Breakage resistance) and EN 61010-1 (Electrical safety)
- Fully-equipped crane scale for low to medium load ranges. The solid design guarantees that extra level of safety (TÜV tested). Thanks to the large LCD display and the remote control which is delivered as standard, it can also be operated safely from a distance and results can be read off
- Thanks to battery operation/rechargeable battery operation (optional), compact, light-weight construction, it is suitable for the use in several locations
- Battery level indicator, LED visual display

- Hold function: For easy reading of the weighing result, the display can be “frozen” in different ways. Either automatically when the weighing value remains unchanged or manually by pressing the Hold key
- Tare: Resets the display to “0” when there is a load on the scale. Now removed or added loads are directly displayed
- Large high-contrasted display that is easy to read
- Standby function: display automatically switched off after 5 min without a change of load. Automatic activation with the touch of a key
- Hook with safety catch, revolving
- Shackle and safety catch made of nickel-plated steel
- **2** Infrared remote control standard, range up to 20 m, W×D×H 65×24×100 mm, batteries included

Technical data

- Backlit LCD display, digit height 28 mm
- Ready for use: Batteries included, 4×1.5 V AA, operating time up to 100 h
- Precision: 0,2 % of [Max]
- Weighing units: kg, lb, N
- Permissible ambient temperature 5 °C/40 °C

Accessories

- Internal rechargeable battery pack for load receptor, operating time up to 50 h without backlight, charging time approx. 12 h. Weighing is not possible during the charging process, KERN HCD-A01, € 50,-



| Model | Weighing capacity [Max] kg | Readability [d] g | Net weight approx. kg | Dimensions | | | | | | | Price excl. of VAT ex works € | Options | |
|---|----------------------------|-------------------|-----------------------|------------|------|------|-------|-------|------|------|-------------------------------|---------------------------|------------|
| | | | | A mm | B mm | C mm | D mm | E mm | F mm | G mm | | DAkkS Calibr. Certificate | DAkkS KERN |
| KERN HCD 60K-2 | 60 | 20 | 1,2 | 150 | 79,3 | 97,7 | 276,1 | 246,5 | 26 | 18 | 200,- | 963-129H | 145,- |
| KERN HCD 100K-2 | 150 | 50 | 1,2 | 150 | 79,3 | 97,7 | 276,1 | 246,5 | 26 | 18 | 200,- | 963-129H | 145,- |
| KERN HCD 300K-1 | 300 | 100 | 1,2 | 150 | 79,3 | 97,7 | 276,1 | 246,5 | 26 | 18 | 200,- | 963-129H | 145,- |
| Multi-division balance, with increasing or decreasing load, it switches automatically to the next largest or smallest weighing range [Max] and readout [d]. | | | | | | | | | | | | | |
| KERN HCD 100K-2D | 60 150 | 20 50 | 1,2 | 150 | 79,3 | 97,7 | 276,1 | 246,5 | 26 | 18 | 210,- | 963-129H | 145,- |
| KERN HCD 300K-2D | 150 300 | 50 100 | 1,2 | 150 | 79,3 | 97,7 | 276,1 | 246,5 | 26 | 18 | 210,- | 963-129H | 145,- |

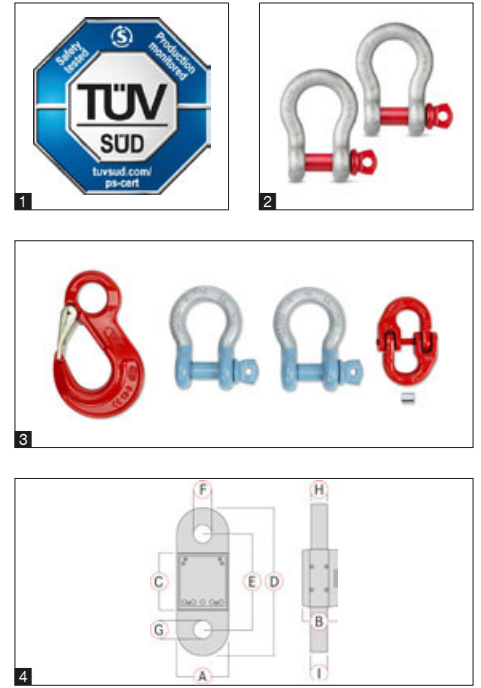

Compact crane scale with integrated display can also be used for tensile force measurement

Features

- **1** With the TÜV certification mark, the scales meet the requirements of the standard EN 13155 (Non-fixed load lifting attachments/ Breakage resistance) and EN 61010-1 (Electrical safety)
- With its high-quality finish, low weight and compact dimensions, this crane scale (tensile force gauge) is an essential device for industrial use
- Because of its compact design it is also ideally suited for installation in systems where space is limited, etc.
- Ideally suited for determining weight quickly while loading and unloading
- Peak load display (peak hold)
- Hold function: For easy reading of the weighing result, the display can be “frozen” by pressing the Hold key
- Tare: Resets the display to “0” when there is a load on the scale. Now removed or added loads are directly displayed

Technical data

- Large backlit LCD display, digit height 23 mm
- Material and design of housing/load support, models with [Max] ≤ 3 t: aluminium/stainless steel bushing [Max] > 3 t: steel/steel
- Rechargeable battery pack integrated, as standard, operating time up to 30 h without backlight, charging time approx. 12 h
- Optional battery operation, 3×1.5 V AA not included in scope of delivery, operating time up to 30 h
- Precision: 0,2 % of [Max]
- Internal measuring frequency: 60 Hz
- Weighing units: kg, lb, N
- Permissible ambient temperature 5 °C/35 °C

Accessories

- **2** High-strength shackle, hot-dipped galvanised cast steel bracket, bow shaped. Scope of delivery: 2 shackles with lacquered screw bolts, suitable for models with [Max] ≤ 5 t: KERN YSC-01, € 125,- [Max] = 10 t: KERN YSC-02, € 270,-
- **3** Hook with safety catch, galvanised and lacquered cast steel, not rotatable, scope of delivery: 2 shackles, 1 connecting link, 1 hook [Max] ≤ 1 t: KERN YHA-01, € 210,- [Max] = 3 t: KERN YHA-02, € 230,- [Max] = 5 t: KERN YHA-03, € 300,- [Max] = 10 t: KERN YHA-04, € 560,-

15

STANDARD



OPTION



| Model | Weighing capacity [Max] kg | Readability [d] g | Net weight approx. kg | 4 Dimensions | | | | | | | | | Price excl. of VAT ex works € | Options | |
|-----------------|----------------------------|-------------------|-----------------------|--------------|------|------|------|------|------|------|------|------|-------------------------------|--------------------|---------------|
| | | | | A mm | B mm | C mm | D mm | E mm | F mm | G mm | H mm | I mm | | DAkKS Calibr. KERN | Certificate € |
| KERN HFA 600K-1 | 600 | 200 | 1,8 | 90 | 62 | 100 | 255 | 165 | 27 | 27 | 30 | 30 | 680,- | 963-130H | 255,- |
| HFA 1T-4 | 1000 | 500 | 1,8 | 90 | 62 | 100 | 255 | 165 | 27 | 27 | 30 | 30 | 680,- | 963-130H | 255,- |
| HFA 3T-3 | 3000 | 1000 | 2,0 | 90 | 62 | 100 | 255 | 165 | 27 | 27 | 30 | 30 | 740,- | 963-132H | 650,- |
| HFA 5T-3 | 5000 | 2000 | 4,0 | 90 | 62 | 100 | 255 | 165 | 30 | 30 | 30 | 30 | 820,- | 963-132H | 650,- |
| HFA 10T-3 | 10000 | 5000 | 6 | 90 | 72 | 100 | 275 | 185 | 40 | 40 | 40 | 40 | 1290,- | 963-133H | 910,- |

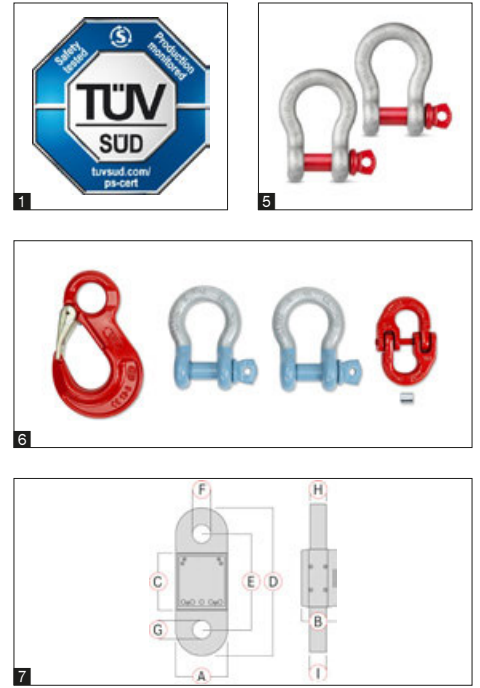

Compact crane scale for use in harsh environmental conditions or where space is limited, with convenient hand-held terminal

Features

- 1 With the TÜV certification mark, the scales meet the requirements of the standard EN 13155 (Non-fixed load lifting attachments/ Breakage resistance) and EN 61010-1 (Electrical safety)
- With its high-quality finish, low weight and compact dimensions, this crane scale (tensile force gauge) is an essential device for industrial use
- Because of its compact design it is also ideally suited for installation in systems where space is limited, etc.
- Peak load display (peak hold)
- Hold function: For easy reading of the weighing result, the display can be "frozen" by pressing the Hold key
- Tare: Resets the display to "0" when there is a load on the scale. Now removed or added loads are directly displayed
- Display device with integrated radio module, which the user can carry around with him, thanks to the convenient hand strap, standard. In this way the weighing data can always be read off the display device by the user, even

when the user is a long way from the load receptor (force gauge) or under poor lighting conditions. Range up to 20 m. All functions can be selected

Technical data

- Material and design of housing/load support, models with [Max] ≤ 3 t: aluminium/stainless steel bushing [Max] > 3 t: steel/steel
- Precision: 0,2 % of [Max]
- Internal measuring frequency: 10 Hz
- Weighing units: kg, lb, N
- Permissible ambient temperature 5 °C/35 °C

Display device

- Large backlit LCD display, digit height 23 mm
- 2 Rechargeable battery pack integrated, as standard, operating time up to 30 h without backlight, charging time approx. 12 h
- Dimensions of display device W×D×H 88×64×256 mm

Load receptor

- 3 Internal rechargeable battery pack included with the delivery, Operating time up to 35 h without backlight, charging time approx. 8 h
- 4 Optional battery operation, 3×1.5 V AA not included in scope of delivery, operating time up to 40 h

Accessories

- 5 High-strength shackle, hot-dipped galvanised cast steel bracket, bow shaped. Scope of delivery: 2 shackles with lacquered screw bolts, suitable for models with [Max] ≤ 5 t: KERN YSC-01, € 125,- [Max] = 10 t: KERN YSC-02, € 270,-
- 6 Hook with safety catch, galvanised and lacquered cast steel, not rotatable, scope of delivery: 2 shackles, 1 connecting link, 1 hook [Max] ≤ 1 t: KERN YHA-01, € 210,- [Max] = 3 t: KERN YHA-02, € 230,- [Max] = 5 t: KERN YHA-03, € 300,- [Max] = 10 t: KERN YHA-04, € 560,-

STANDARD



OPTION



| Model | Weighing capacity [Max] kg | Readability [d] g | Net weight approx. kg | 7 Dimensions | | | | | | | | | | Price excl. of VAT ex works € | Options DAKKS Calibr. Certificate | |
|-----------------|----------------------------|-------------------|-----------------------|--------------|------|------|------|------|------|------|------|------|------------|-------------------------------|-----------------------------------|--|
| | | | | A mm | B mm | C mm | D mm | E mm | F mm | G mm | H mm | I mm | DAKKS KERN | | € | |
| KERN HFC 600K-1 | 600 | 200 | 1,8 | 90 | 62 | 100 | 255 | 165 | 27 | 27 | 30 | 30 | 1070,- | 963-130H | 255,- | |
| HFC 1T-4 | 1000 | 500 | 1,8 | 90 | 62 | 100 | 255 | 165 | 27 | 27 | 30 | 30 | 1070,- | 963-130H | 255,- | |
| HFC 3T-3 | 3000 | 1000 | 2,2 | 90 | 62 | 100 | 255 | 165 | 27 | 27 | 30 | 30 | 1140,- | 963-132H | 650,- | |
| HFC 5T-3 | 5000 | 2000 | 4,0 | 90 | 62 | 100 | 255 | 165 | 30 | 30 | 30 | 30 | 1220,- | 963-132H | 650,- | |
| HFC 10T-3 | 10000 | 5000 | 6 | 90 | 72 | 100 | 275 | 185 | 40 | 40 | 40 | 40 | 1690,- | 963-133H | 910,- | |



KERN HFD/HFD-IP



KERN HFD-M



Robust, high-resolution crane scale up to 12 t, also with optional verification or protection type IP67



High mobility: thanks to rechargeable battery operation, compact, lightweight construction, it is suitable for the use in several locations (production, warehouse, dispatch department, etc.)

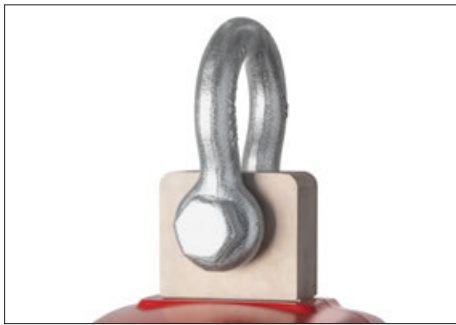

Solid shackles, non-revolving



Radio remote control standard. Range up to 20 m. All functions can be selected (excl. ON/OFF). W×D×H 65×24×100 mm. Batteries included, 1×12V, 23A

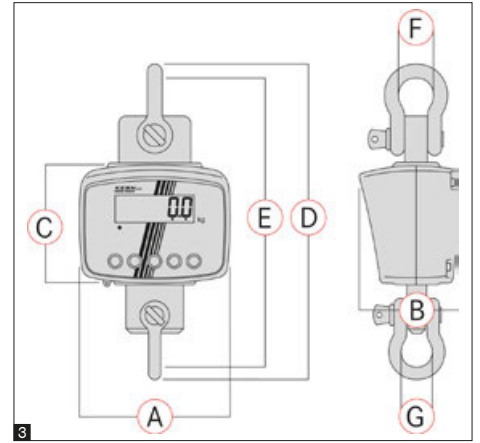

Features

- With the TÜV certification mark, the scales meet the requirements of the standard EN 13155 (Non-fixed load lifting attachments/ Breakage resistance) and EN 61010-1 (Electrical safety)
- Because of its stable construction and robust design, it is ideal for continuous use in industrial environment
- Tare: Resets the display to "0" when there is a load on the scale. Now removed or added loads are directly displayed

KERN HFD/HFD-IP

- Hold function: the weight display is "frozen" when the Hold button is pressed

KERN HFD-IP

- The models with IP add-on have special spray and dust protection to IP67 and because of this they are ideal for use in harsh environments

KERN HFD-M

- The models with M add-on can be verified optionally and because of this they are ideal for use in verified applications such as, for example, calculation of a total price, based on weight
- Will support you when weighing freight in a SOLAS compliant manner
- Sleep function: when the sleep button is pressed, the weight display is switched off, but the value remains stored. This can extend the battery life

Technical data

- Superior display size: digit height 30 mm, bright backlight for easy reading of weighing results, even in poor lighting conditions
- Rechargeable battery pack integrated, as standard, operating time up to 70 h without backlight, charging time approx. 12 h. Battery pack accessible from the outside, which means it is easy to replace
- Precision: 0,2 % of [Max]
- Weighing units: kg
- Permissible ambient temperature -10 °C/40 °C

Accessories

- Charging station for external battery charging, scope of delivery: charging station, exchangeable battery, mains adapter, KERN HFD-A07, € 120,-
- Hook with safety catch, cast steel, galvanised and lacquered, non-revolving, suitable for models
 [Max] ≤ 1t: KERN HFD-A01, € 50,-
 [Max] = 3t: KERN HFD-A02, € 70,-
 [Max] ≥ 6t: KERN HFD-A03, € 130,-

STANDARD: CAL EXT, SUM, IP 67, ACCU, MULTI, DMS, 1 DAY

OPTION: DAKKS +3 DAYS

FACTORY: M +3 DAYS HFD-M

| Model | Weighing capacity [Max] kg | Readability [d] g | Net weight approx. kg | Dimensions | | | | | | Price excl. of VAT ex works € | Verification M KERN € | Options | |
|-------|----------------------------------|-------------------------|--------------------------|------------|---|---|---|---|-----|----------------------------------|--------------------------------|---------------|------------------|
| | | | | A | B | C | D | E | F=G | | | DAkkS KERN | Certificate € |

Multi-range balance, with increasing load it switches automatically to the next largest weighing range [Max] and readout [d] and when the load is fully removed, the balance switches back to the lower range

| | | | | | | | | | | | | | | |
|---|---------------------|--------------------|----|-----|-----|-----|-----|-----|------|--------|---|---|----------|-------|
| HFD 600K-1 | 150 300 600 | 50 100 200 | 9 | 194 | 129 | 160 | 422 | 384 | 50,8 | 480,- | - | - | 963-130H | 255,- |
| HFD 1T-4 | 300 600 1500 | 100 200 500 | 9 | 194 | 129 | 160 | 422 | 384 | 50,8 | 490,- | - | - | 963-130H | 255,- |
| HFD 3T-3 | 600 1500 3000 | 200 500 1000 | 10 | 194 | 129 | 160 | 457 | 413 | 58 | 670,- | - | - | 963-132H | 650,- |
| HFD 6T-3 | 1500 3000 6000 | 500 1000 2000 | 15 | 194 | 129 | 160 | 518 | 467 | 68,3 | 850,- | - | - | 963-132H | 650,- |
| HFD 10T-3 | 3000 6000 12000 | 1000 2000 5000 | 22 | 194 | 129 | 160 | 584 | 521 | 82,5 | 990,- | - | - | 963-133H | 910,- |
| Protection against dust and water splashes IP67 | | | | | | | | | | | | | | |
| HFD 600K-1IP | 150 300 600 | 50 100 200 | 9 | 194 | 129 | 160 | 422 | 384 | 50,8 | 590,- | - | - | 963-130H | 255,- |
| HFD 1T-4IP | 300 600 1500 | 100 200 500 | 9 | 194 | 129 | 160 | 422 | 384 | 50,8 | 600,- | - | - | 963-130H | 255,- |
| HFD 3T-3IP | 600 1500 3000 | 200 500 1000 | 10 | 194 | 129 | 160 | 457 | 413 | 58 | 740,- | - | - | 963-132H | 650,- |
| HFD 6T-3IP | 1500 3000 6000 | 500 1000 2000 | 15 | 194 | 129 | 160 | 518 | 467 | 68,3 | 920,- | - | - | 963-132H | 650,- |
| HFD 10T-3IP | 3000 6000 12000 | 1000 2000 5000 | 22 | 194 | 129 | 160 | 584 | 521 | 82,5 | 1060,- | - | - | 963-133H | 910,- |

Note: For devices that require verification (conformity assessment according to NAWI 2014/31/EU), please include the verification when placing your order.

The initial verification is not possible after delivery. Please inform the full address of the location of use for the initial verification.

| | | | | | | | | | | | | | | |
|-------------|-------|------|----|-----|-----|-----|-----|-----|------|--------|----------|-------|----------|-------|
| HFD 600K-1M | 600 | 200 | 9 | 194 | 129 | 160 | 422 | 384 | 50,8 | 650,- | 965-130H | 150,- | 963-130H | 255,- |
| HFD 1T-4M | 1500 | 500 | 9 | 194 | 129 | 160 | 422 | 384 | 50,8 | 660,- | 965-130H | 150,- | 963-130H | 255,- |
| HFD 3T-3M | 3000 | 1000 | 10 | 194 | 129 | 160 | 457 | 413 | 58 | 860,- | 965-132H | 235,- | 963-132H | 650,- |
| HFD 6T-3M | 6000 | 2000 | 15 | 194 | 129 | 160 | 518 | 467 | 68,3 | 1050,- | 965-132H | 235,- | 963-132H | 650,- |
| HFD 10T-3M | 12000 | 5000 | 20 | 194 | 129 | 160 | 584 | 521 | 82,5 | 1200,- | 965-133H | 355,- | 963-133H | 910,- |

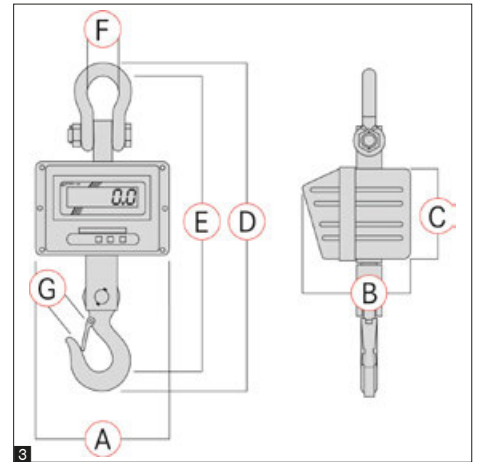

Robust industrial crane scale with bright LED display for optimum reading in unfavourable ambient conditions

Features

- **1** With the TÜV certification mark, the scales meet the requirements of the standard EN 13155 (Non-fixed load lifting attachments/ Breakage resistance) and EN 61010-1 (Electrical safety)
- Professional device for robust applications in production, quality control, logistics etc. Because of its stable construction and robust design, it is ideal for continuous use in industrial environment
- Thanks to rechargeable battery operation, compact, lightweight construction, it is suitable for the use in several locations
- Adaptation of the readout to unstable environmental conditions at the push of a button (you can select between 3 levels)
- Hold function: For easy reading of the weighing result, the display can be "frozen" by pressing the Hold key

- Tare: Resets the display to "0" when there is a load on the scale. Now removed or added loads are directly displayed
- Hook with safety catch, revolving
- **2** Radio remote control standard. Range up to 20 m. All functions can be selected (excl. ON/OFF). W×D×H 48×10×95 mm. Batteries included, 12 V, Typ 23A

Technical data

- Superior display size: digit height 30 mm, bright backlight for easy reading of weighing results, even in poor lighting conditions
- Rechargeable battery pack integrated, as standard, operating time up to 50 h without backlight, charging time approx. 14 h
- Precision: 0,2 % of [Max]
- Weighing units: kg
- Permissible ambient temperature 0 °C/40 °C

15

STANDARD

CAL EXT ACCU MULTI DMS 1 DAY 2 DAYS

OPTION

DAkkS +3 DAYS

HFM 10T1

| Model | Weighing capacity [Max] kg | Readability [d] g | Net weight approx. kg | 3 Dimensions | | | | | | | Price excl. of VAT ex works € | Options | |
|------------------|----------------------------|-------------------|-----------------------|--------------|------|------|------|------|------|------|-------------------------------|------------|---------------|
| | | | | A mm | B mm | C mm | D mm | E mm | F mm | G mm | | DAkkS KERN | Certificate € |
| HFM 1T0.1 | 1000 | 100 | 14 | 270 | 200 | 175 | 610 | 540 | 68 | 40 | 1010,- | 963-130H | 255,- |
| HFM 3T0.5 | 3000 | 500 | 16 | 270 | 200 | 175 | 610 | 540 | 74 | 40 | 1040,- | 963-132H | 650,- |
| HFM 5T0.5 | 5000 | 500 | 18 | 300 | 230 | 190 | 730 | 650 | 74 | 55 | 1400,- | 963-132H | 650,- |
| HFM 10T1 | 10000 | 1000 | 34 | 300 | 230 | 190 | 840 | 750 | 92 | 60 | 1860,- | 963-133H | 910,- |

16



ACCESSORIES, SOFTWARE

In our large selection of accessories you will discover everything you need to complement your KERN devices in the best way and make your workflows even more efficient.

As well as high-quality printers, interface cables and numerous adapters, you will also find different software solutions and many other products which will guarantee stable performance.

Visit our webshop as well to see the complete range of accessories and get detailed information about each product.



**Matrix Needle Printer
KERN 911-013***

For printing weighing results on normal paper, which is ideal for long-term archiving.



**Matrix Needle Printer
KERN YKN-01***

For printing weighing results on normal paper, which is ideal for long-term archiving.

NEW



**Thermal Printer
KERN YKC-01**

Reliable thermal printer for standard applications.

Technical data

- Needle print
- Speed: 1,8 line/s
- Max. 40 characters per line
- Width of the paper strip: 57 mm wide
- Operation via mains adapter 230 V/50 Hz (standard EU), as standard
- Dimensions housing: W×D×H 100×180×106 mm
- Not suitable for KERN PNS/PNJ, PES/PEJ ranges
- Interface cable not included with delivery

Price printer without interface cable, KERN 911-013, **€ 480,-**

Accessories

- Paper rolls (10 pcs.), KERN 911-013-010, **€ 40,-**
- Power Adapter, EU/GB/US/CH/AUS, KERN YKA-42, **€ 85,-**

Technical data

- Needle print
- Speed: 1 line/s
- Max. 16 characters per line
- Width of the paper strip: 44 mm wide
- Operation via mains adapter 230 V/50 Hz (standard EU/GB/US), as standard
- Dimensions housing: W×D×H 158×106×40 mm
- Interface cable not included with delivery

Price printer without interface cable, KERN YKN-01, **€ 310,-**

Accessories

- Paper rolls (5 pcs.), KERN YKN-A01, **€ 38,-**

Technical data

- Thermal print
- Speed: 300 mm/s
- Max 58 characters per line
- Supported paper widths: 80 mm (roll)
- Operation via mains adapter 230 V/50 Hz standard EU, as standard
- Interfaces: RS-232
- Dimensions housing W×D×H 125×125×150 mm
- Interface cable not included with delivery

Price printer without interface cable, KERN YKC-01, **€ 310,-**

Accessories

- Paper rolls (5 pcs.), KERN YKC-A10, **€ 50,-**

! * ONLY WHILE STOCKS LAST

STANDARD

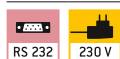

STANDARD

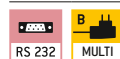

STANDARD

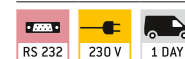

Important note for printer orders:

Please state your balance model when ordering, so that the printer can be preconfigured in the factory to suit your balance.

Individual header data:

For printers **KERN 911-013 and YKN-01** the free software **KERN SHM-01** (see www.kern-sohn.com) can be used to print 4 header lines on the printout (see marking on balance).

Compatible models: KERN 440, DE, FCB, PCD.



**Dot Matrix Printer
KERN YKG-01**

High-quality dot matrix printer

Flexible and rapid dot matrix printer for retail, the catering trade and for restaurant kitchens. To print the weights on normal paper, which is ideal for long-term archiving. This model has an interchangeable interface and you will be impressed by how easy it is to replace the paper and ribbon

Technical data

- Needle print
- Speed: 4,7 line/s
- Max. 42 characters per line
- Supported paper widths: 58 mm, 70 mm, 76 mm (roll)
- Operation via mains adapter 230 V/50 Hz standard EU, as standard
- Interfaces: RS-232, cash drawer connection, bidirectional parallel
- Interface cable not included with delivery
- Dimensions housing WxDxH 160x248x139 mm
- Not suitable for KERN DAB, DBS, DLB, FKT, RFE ranges

Price printer without interface cable, KERN YKG-01, **€ 590,-**

Accessories

- Paper rolls (5 pcs.), KERN YKG-A01, **€ 30,-**

**Thermal Printer
KERN YKH-01**

High-quality thermal printer – fast, robust, user-friendly

Robust, low-maintenance thermal printer for retail, the catering trade and for restaurant kitchens. Extremely compact and long-lasting. Thanks to the waterproof switch cover it is particularly suitable for use under tough, loud environmental conditions

Technical data

- Thermal print
- Speed: 2 line/s
- Max 64 characters per line
- Supported paper widths: 58 mm, 80 mm (roll)
- Operation via mains adapter 230 V/50 Hz standard EU, as standard
- Interfaces: RS-232
- Interface cable not included with delivery
- Dimensions housing WxDxH 140x199x146 mm
- Not suitable for KERN DAB, DBS, DLB, FKT, RFE ranges

Price printer without interface cable, KERN YKH-01, **€ 420,-**

Accessories

- Paper rolls (5 pcs.), KERN YKH-A01, **€ 30,-**

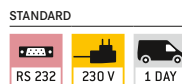
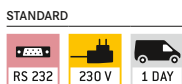

Important note for printer orders:

Please state your balance model when ordering, so that the printer can be preconfigured in the factory to suit your balance.

Individual header data:

For printers **KERN 911-013 and YKN-01** the free software **KERN SHM-01** (see www.kern-sohn.com) can be used to print 4 header lines on the printout (see marking on balance).
Compatible models: KERN 440, DE, FCB, PCD.



Tip:

EasyTouch Individual Print

The print product (e.g. labels) can be individually designed. The size of the print area as well as the placement of the print elements can be customized. The barcode function enables the printing of each element as a barcode or QR code.

For further details, see *EasyTouch*



Example printouts with ET Individual Print

Interface Cable for RS-232

For direct connection to a printer or PC, cable length approx. 1.5 m.
The interface parameters can be set using the balance keypad.

Tip:

The interface cable is **free of charge** if you purchase balance, printer or Ethernet-/WiFi-/Bluetooth adapter together.

| Printer, ... | | PC, YKI-01, -02, -03 KERN | 911-013, YKN-01 KERN | YKG-01, YKH-01 KERN | Price cable excl. of VAT ex works € |
|--|---|------------------------------------|----------------------------|---------------------------|--|
| 440, 572, 573, ALJ, ALS, ALT-B, DE-D, EMB-V, FKA, FKB, KB, PCB, PCD, PLJ, PLS, KDP | CDS, CKE, FCB, DS, FKB-A, (until year of construction 2022) | | 572-926 | | 50,- |
| EOC, IOC, BID, KIB-T, KIB-TM, UID | | | EOC-A12 | | 50,- |
| YKV-01, KGP | | 572-926 | | - | 50,- |
| ABJ-NM, ABS-N | | | ACS-A01 | | 115,- |
| KFB-TM, KFN-TM, NFC (until year of construction 2019) | PFB, SFB, UFB, UFC, NFC | | CFS-A01 | | 50,- |
| CPB, EWJ, KFS-TM, PFB, PFB-M | | | CFS-A01 | | |
| CFS, CCS, KFS-TM, IFS (from year of production 2015) | | - | CFS-A01 | - | |
| ABT-NM, PBJ, PBS | | | 770-926 | | |
| DBS, DLB | | | 572-926 | | |
| DAB | | | MLB-A05 | | |
| ABP, KFS-T | | | MLB-A05 | | |
| ADB, ADJ, ACS, ACJ, PNS/PNJ | | | MLB-A05 | | |
| HFT | | | KFF-A01 | | |
| EG-N, EW-N | | | 474-926 | | |
| PES/PEJ | | | | | |
| CCA | | | CCA-A01 | | |
| RFE, RPB (not compatible with YKN-01) | | - | CFS-A01 | CFS-A01 | |
| FES/FEJ, PWS | | | MLB-A05 (PWS-A02) | | 50,- (300,-) |

With products from KERN you are ready to face the challenges of Industry 4.0

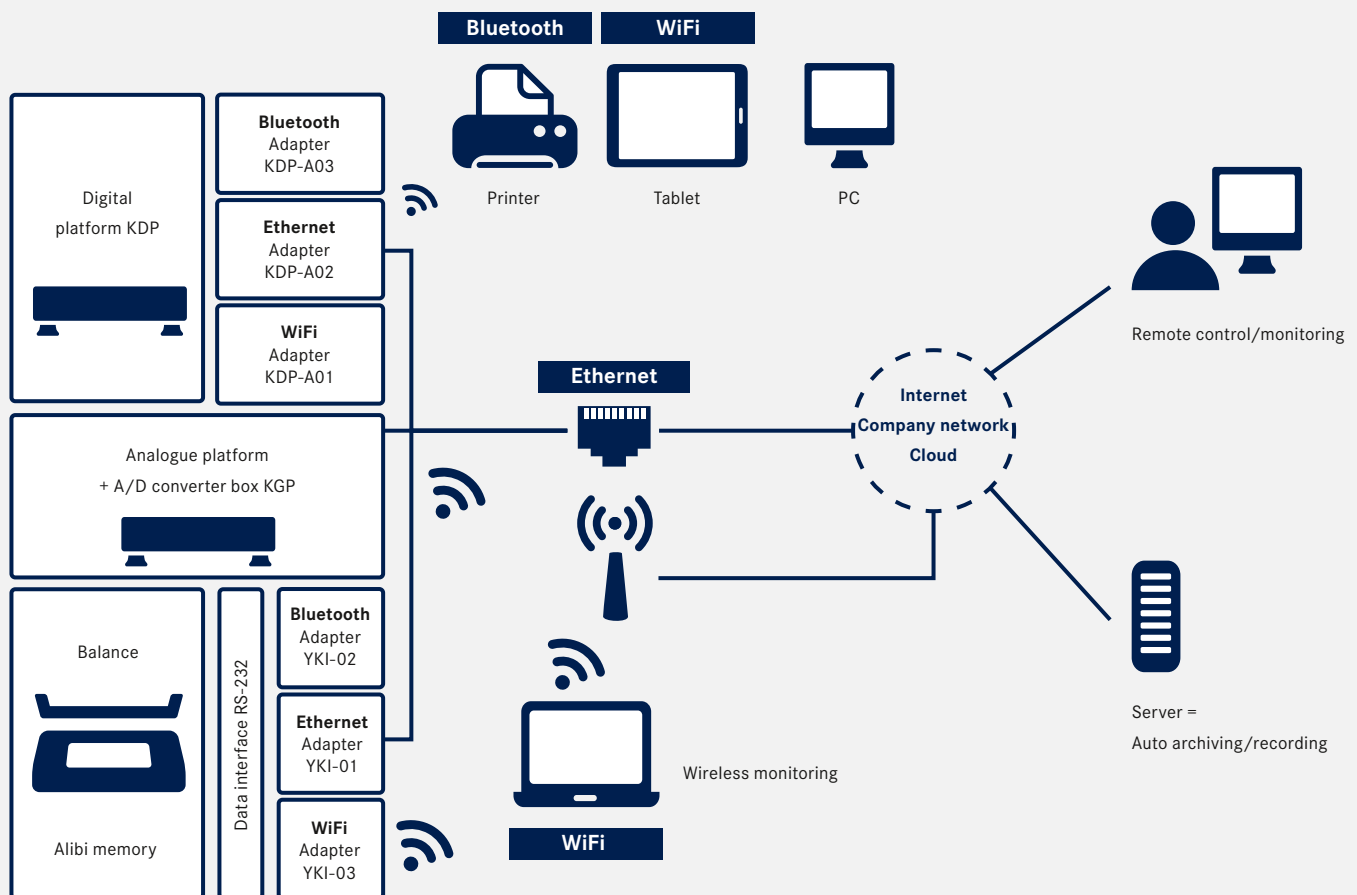

We will help to combine industrial production with the latest information and communication technology, with the aim of improving quality, reducing costs and using time and resources more efficiently so that you are able to react to future requirements in a more flexible manner. You will benefit from our uniform data protocol combined with our BalanceConnection 4.0 data software, for details please see page 179/180.

KERN Software BalanceConnection SCD-4.0

Flexible recording or transfer of measurements, particularly to Microsoft® Excel

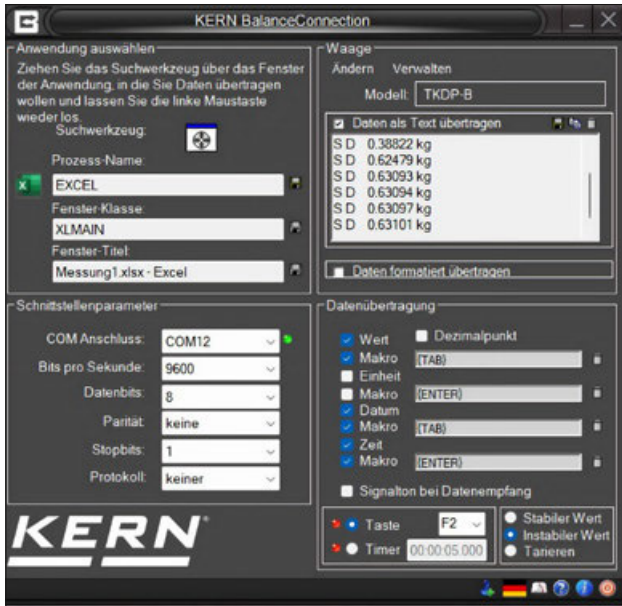

Programme start and quick configuration of the RS232/USB interface

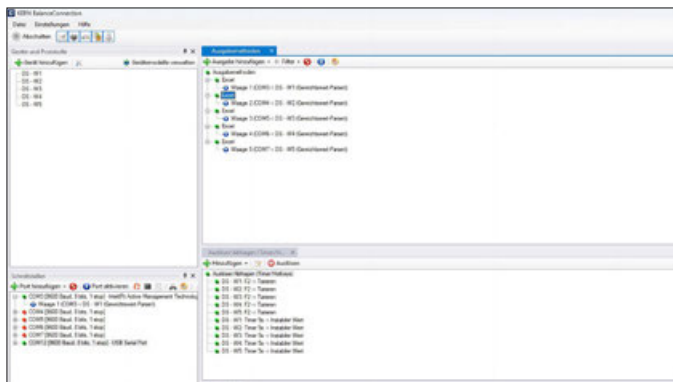

Full overview of devices, outputs, queries, interfaces, etc. directly in the output window

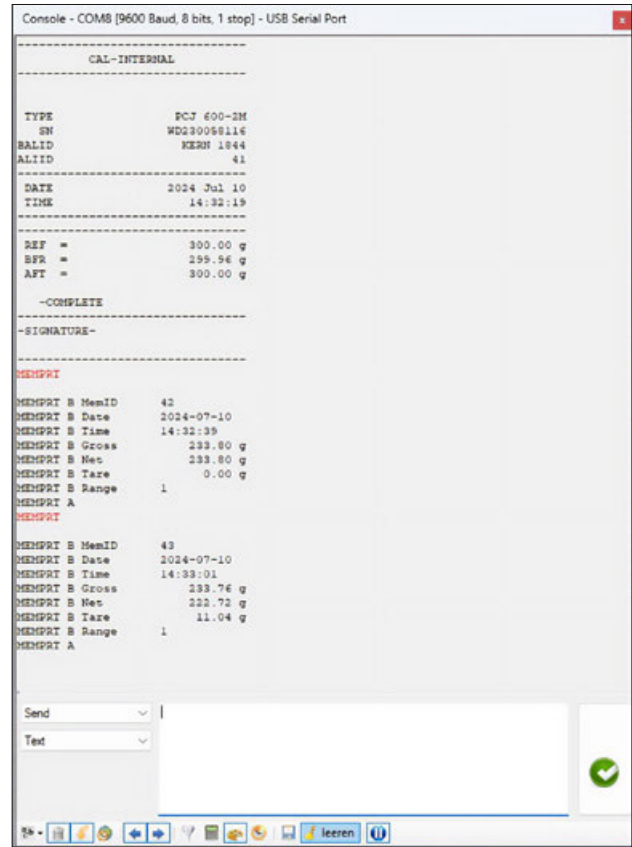

Query measurement results, calibration protocol or alibi memory data via remote control commands. Can be saved as a text file.

Do you have any questions?
 The team from our Industry 4.0 centre of expertise will be happy to help: e-mail: etsales@kern-sohn.com

Tip: Or download a free demo version of the BalanceConnection software: <http://balanceconnection.kern-sohn.com/demo>

Features

- For operating systems Windows 10, 11, -.NET Framework 4.8.1 required
- Supports balances measuring devices with RS 232, RS 485, Bluetooth, LAN or WiFi network (TCP/UDP/IP)
- Highly flexible formatting of the output (any order, formatting and rounding), particularly recording of date and time for every value transferred, if required
- Any number of devices/interfaces can be connected, as well as simultaneous and synchronised recording of several balances
- Key-activated or time-controlled interrogation of measurements or trigger of device functions, also for continuous recording
- The interface protocols for KERN balances are already predefined (standard configuration)

- Compatible interface cable included when you order a KERN balance at the same time
- Many different transfer and recording options:
 - Microsoft® Excel/Access/Word in the foreground or background
 - Other Windows applications (through key simulation), e.g. shipping software or ERP system (SAP, Sage, etc.)
 - File recording (e.g. as text or CSV file)
 - Print out on text or label printer
 - Screen output such as large display, line chart (drying curve for moisture analyser), histogram, etc.

Benefits

- Typing errors during e.g. manual transfer are avoided
- Automatic recording, e.g. for long-term tests
- Supports GLP-compliant processes
- Can be used across different branches and applications
- Also available immediately as a download license
- Scope of supplies: Download link for 1 license, KERN SCD-4.0-DL, € 210,-

KERN Software BalanceConnection SCD-4.0

Professional and highly flexible recording or transmission of measured values, in particular also to Microsoft® Excel or Access

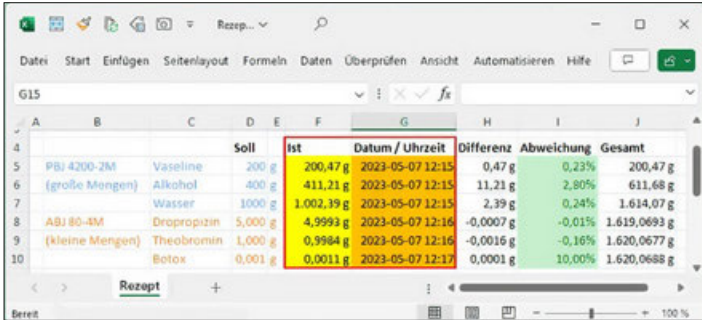

| Soll | Ist | Datum / Uhrzeit | Differenz | Abweichung | Gesamt |
|---------|------------|------------------|-----------|------------|--------------|
| 200 g | 200,47 g | 2023-05-07 12:13 | 0,47 g | 0,23% | 200,47 g |
| 400 g | 411,21 g | 2023-05-07 12:15 | 11,21 g | 2,80% | 611,68 g |
| 1000 g | 1.002,39 g | 2023-05-07 12:15 | 2,39 g | 0,24% | 1.614,07 g |
| 5.000 g | 4,9993 g | 2023-05-07 12:16 | -0,0007 g | -0,01% | 1.619,0693 g |
| 1.000 g | 0,9984 g | 2023-05-07 12:16 | -0,0016 g | -0,16% | 1.620,0677 g |
| 0,001 g | 0,0011 g | 2023-05-07 12:17 | 0,0001 g | 10,00% | 1.620,0688 g |

Easy transfer and editing of measuring results e.g. in Microsoft® Excel

Do you have any questions?

The team from our Industry 4.0 centre of expertise will be happy to help:
e-mail: etsales@kern-sohn.com

Tip: Or download a free demo version of the BalanceConnection software: <http://balanceconnection.kern-sohn.com/demo>

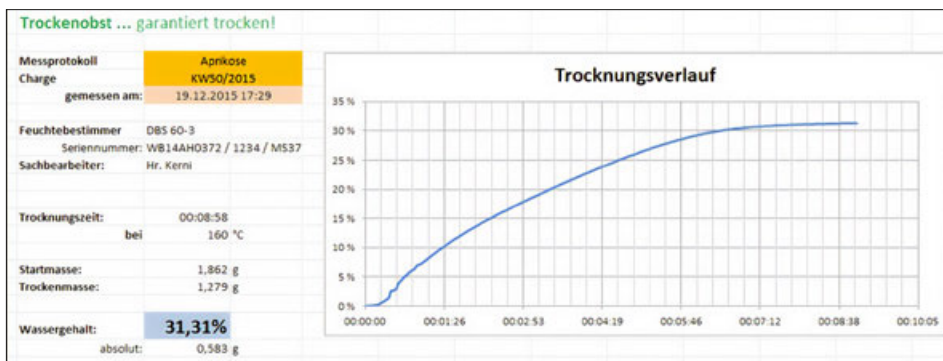

Measurement protocol with moisture analysis progression diagram

Features

- For operating systems Windows 10, 11, -.NET Framework 4.8.1 required
- Supports balances measuring devices with RS 232, RS 485, Bluetooth, LAN or WiFi network (TCP/UDP/IP)
- Highly flexible formatting of the output (any order, formatting and rounding), particularly recording of date and time for every value transferred, if required
- Any number of devices/interfaces can be connected, as well as simultaneous and synchronised recording of several balances
- Key-activated or time-controlled interrogation of measurements or trigger of device functions, also for continuous recording
- The interface protocols for KERN balances are already predefined (standard configuration)
- Compatible interface cable included when you order a KERN balance at the same time
- Many different transfer and recording options:
 - Microsoft® Excel/Access/Word in the foreground or background
 - Other Windows applications (through key simulation), e.g. shipping software or ERP system (SAP, Sage, etc.)
 - File recording (e.g. as text or CSV file)
 - Print out on text or label printer
 - Screen output such as large display, line chart (drying curve for moisture analyser), histogram, etc.

Additional features of the PRO version

- ODBC/SQL databases such as SQL Server or MySQL
- Transfer to HTTP Webservices/Web forms
- Histogram
- Enables the connection of medical balances to practice EDP systems using the device data transfer protocol (GDT) and also the HL7 protocol
- Implementation of programs/scripts using freely-definable command lines
- Command sequences
- Defining the conditions for specific events and the reaction to these events
- Filter for stability recognition (configurable value storage)
- Central configuration repository, e.g. on the network
- On-screen displays with configurable user interface for flexible balance operation

Benefits

- Ideal software where weighing data which has been collected needs to be transferred to a Windows PC
- Particularly suitable for professional integration of weighing systems into existing networks where there is a high demand for automated data transfer and further processing, for integration of databases
- Automatic recording, e.g. for long-term tests
- Supports GLP-compliant processes
- Can be used across different branches and applications
- Any number of balances can be used on one PC/workstation per licence
- Also available immediately as a download license
- Scope of supplies: Download link for 1 License, KERN SCD-4.0-PRO-DL, **€ 380,-**

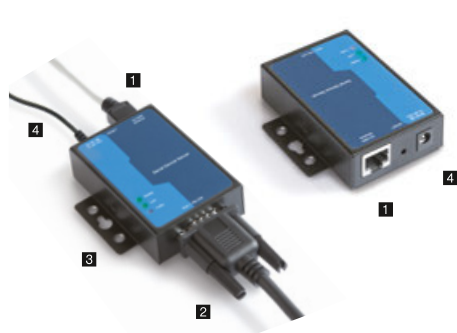

**RS-232/Ethernet Adapter
KERN YKI-01**

Technical data

Adapter to connect balances, force measuring devices etc. with an RS-232 interface **2** to an IP-based Ethernet network **1**. The adapter allows direct integration of measuring devices into most company networks, with automatic configuration using DHCP or statistical IP allocation. You can access the current measuring data at any time from within the whole network, without having to use additional cables. The adapter supports a wide range of configurational options using the enclosed administration software or by the web interface. The driver delivered with the goods allows you to access the measuring device with existing, non-network-compatible applications using a virtual COM port. Compatible with KERN BalanceConnection software. DIN track mount **3** or free-standing. Scope of delivery: RS-232 Ethernet adapter with 1x Port RS-232 **1**, mains adapter **4**, CD (driver, software, operating instructions), adhesive feet

KERN YKI-01, € 380,-

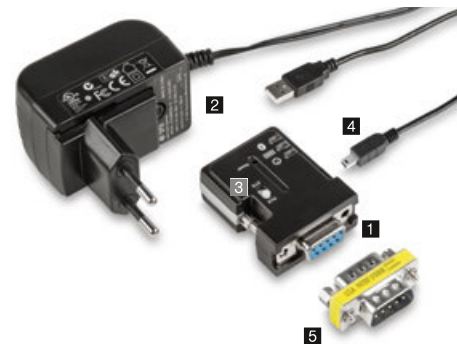

**RS-232/Bluetooth Adapter
KERN YKI-02**

Technical data

Adapter for the wireless connection of balances, force measuring devices etc. with an RS-232 interface to Bluetooth devices, such as Bluetooth printers, tablets, laptops, Smartphones etc. In this way, where there is a physical separation or a large distance between the devices, the weighing data from one or several balances can be easily sent without cable and printed on a Bluetooth printer or transferred to a Bluetooth device (you would need the relevant software on the Bluetooth device, not included with the delivery). The compact adapter with its attractive design can usually be connected directly to the balance **1**, e.g. an additional interface cable would not be necessary. Bluetooth adapter will be powered by the balance (if compatible) or with the mains adapter which is supplied as standard **2**. Range up to 100 m outside, depending on obstacles, such as, walls, the sensitivity and type of antenna of the receiver. Intersections of sending and receiving lines using the DCE/DTE switch **3**. Compatible with KERN Software BalanceConnection.

Scope of delivery: RS-232/Bluetooth adapter, mains adapter (EU/GB/US/AUS/CH) **2**, USB-A to Mini-USB-B cable **4**, gender changer **5**, driver CD,

KERN YKI-02, € 380,-

STANDARD

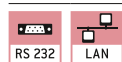

STANDARD

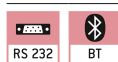

Note: To connect to your network, you will need information from your network administrator. We recommend discussing connecting your device into your network with the administrator before you place your order.

Note: If you order a KERN balance at the same time, then the interface cable is **free of charge** (please specify balance model).



**Large Display
KERN YKD-A02**

Technical data

With superior display size, digit height 3" (76 mm). Luminescent, red LED display for easy reading of weight, even from a distance or under poor lighting conditions. 6 segments, mains connection as standard (230 V, EU/GB), connection using RS-232 data interface, dimensions WxDxH 541x55x180 mm.

Suitable for serie UFA

KERN YKD-A02, € 310,-

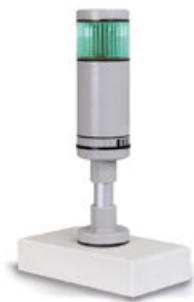

**Signal Lamp
KERN CFS-A03**

Technical data

Signal lamp for visual support of weighing with tolerance range. Three-colour LED, red, green, yellow. Power supply via balance using RS-232. Total dimensions WxDxH 100x180x300 mm

Suitable for series BID, CDS, CKE, CPB-N, DS, FCB, FKB, IFS, IFC, IOC, IXC, KFB-TM, KFN-TM, KIB-TM, NFC, SFB, SXC, UFA, UFC

KERN CFS-A03, € 310,-



**Power Supply Adapter Set
KERN YKA-02**

Technical data

From standard EU to GB/US/AUS/CH etc. Four pieces. Ideal for devices with Class II protection (not earthed). Ideal for Euro moulded plug,

KERN YKA-02, € 35,-



**2nd RS-232 Data Interface
KERN CFS-A04**

Technical data

Separate Y cable, e.g. for simultaneous connection of a printer and a signal lamp.

Suitable for series CFS, CPB-N, KFB-TM, UFA, SFB,

KERN CFS-A04, € 38,-



**RS-232/USB Adapter
KERN AFH 122**

Technical data

To connect peripheral devices with USB connection, fits on all balances and measuring instruments with RS-232 port.

Please order the appropriate RS-232 interface cable for your balance at the same time, see table on Page 178

Scope of delivery: Converter cable, CD with driver,

KERN AFH 12, € 95,-



Stand (Tripodal)
KERN YKP-02

Technical data

stable and robust, to elevate display device, stainless steel, height-adjustable, large three-legged adjustable foot, height of stand approx. 750–1000 mm, Factory Option.

Suitable for series BFB, BXS, BFS, BFA, IFS, IFB, KFE-TM, KXG-TM, KXS-TM, KEN-TM, NFC, SFE, UFA, UFB,

KERN YKP-02, € 220,-



Protective Dust Cover
KERN ABS-A08

Technical data

For protection from dust and light (Fig. similar).

Suitable for all KERN analytical balances and precision balances with glass draught shield,

KERN ABS-A08, € 32,-



Tare Pan
KERN RFS-A02

Technical data

Made of stainless steel, which makes cleaning easy and hygienic. Ideal for weighing loose screws, small parts as well as fruit, vegetables, cheese, etc.

- W×D×H 400×300×45 mm
- Net weight approx. 554 g

KERN RFS-A02, € 75,-



Tare Pan with Pan Beam
KERN CH-A01N

Technical data

Made of stainless steel. Ideal for weighing loose small parts as well as fruit, vegetables etc. Max. load 30 kg. Removable tare pan which makes cleaning easy and hygienic.

Suitable for models KERN CH 15K20, HCB 20K10, HDB-N, HDB-XL

- Dimensions: tare pan, ϕ /H 160×40 mm (dim. outside), 240×40 mm (dim. inside)
- Pan beam: W×D×H 290×240×300 mm 290×240×340 mm (incl. tare pan)
- Total net weight approx. 500 g

KERN CH-A01N, € 88,-



Universal Density Set
KERN YDB-03

Technical data

Universal density set for precise and convenient density determination of liquids and solids $\leq/\geq 1$. Suitable for all current KERN analytical balances. Scope of delivery: Beaker (ϕ ×H 84×113 mm), thermometer, sample holder, adapter, equalising weights, volume plummet (stainless steel, 20 g), universal submersible basket for solid bodies which float and sink. The wire of the submersible basket has a diameter of 0.5 mm and therefore complies with the requirements of DIN EN ISO 1183-1 (test methods for the determination of density of non-foamed plastics), KERN YDB-03, € 380,-

Optional:

Density determination of the volume plummet, DAkkS calibration certificate with all data relating to the density and volume, KERN 962-335V, € 175,-



ESD Earthing Kit
KERN YGR-01

Technical data

ESD drain to protect against electrostatic discharge e.g. for electrostatically-charged weighing objects or people who work with the scale, KERN YGR-01, € 60,-



Ioniser to neutralise Electrostatic Charge KERN YBI-01A

Technical data

Goods to be weighed which are non-conductive, such as plastic, china, glass, etc often carry electrostatic charge. The electromagnetic field which then occurs between the goods to be weighed and the balance can cause the weighing result to be distorted by up to a gramme. Therefore, when weighing in milligrammes or even smaller increments, we recommend neutralising the electrostatic charge with the KERN AC-Korona discharge ioniser. With feet supplied with the ioniser, it can be positioned conveniently next to the balance or you can manually direct it from all sides onto a particular item to be weighed.

- Discharge of ozone 0,05 ppm/h
- Total dimensions WxDxH
115x100x60 mm (Adjustable foot retracted),
115x110x80 mm (Adjustable foot folded out)
- Net weight approx. 0,31 kg
- Mains connection 100–240 V, 50/60 Hz, AC power supply, DC 12 V, 500 mA, output,

KERN YBI-01A, € 950,-



Weighing Table KERN YPS-03

Technical data

The KERN YPS-03 weighing table has been constructed to absorb vibrations and oscillations, which would otherwise distort the weighing result.

The YPS-03 weighing table consists of:

- a heavy, polished granite slab (24 kg) and is positioned on absorbing rubber components and is used as a surface on which to stand the analytical balance
- a work table, the work surface of which surrounds the slab and offers many storage options. The sturdy powder-coated steel frame has four height-adjustable feet, which can be used to accurately level the weighing table if the floor is at all uneven
- You can work in an ergonomic way at the weighing table whether you are in a standing or seated position. The inlet on the front of the table offers enough space for you to sit down and operate the scale without touching the weighing table.
- All surfaces are hygienic and easy to clean
- Suitable for all KERN analytical balances with total dimensions $\leq W \times D$ 300x400 mm
- Total dimensions WxDxH
785x600x800 mm (Height adjustable)
- Dimensions granite slab, WxDxH
300x400x80 mm
- Net weight approx. 46 kg

Ready for shipping in 2 working days. Dispatch complete on pallet, simple self-assembly. Please ask for dimensions, gross weight, shipping costs,

KERN YPS-03, € 990,-

STANDARD



Anti-vibration Granite Plates KERN YPS-04, YPS-05, YPS-06

Technical data

- The KERN YPS-04, -05, -06 anti-vibration granite plates are designed to dampen shocks and vibrations that would otherwise distort the weighing results of high precision Laboratory Scales and analytical balances. Also ideal for vibration-free microscope set-up
- The anti-vibration granite plate is made of polished granite, which is supported on absorbent damping elements
- The anti-vibration granite plate can be used ergonomically while standing or sitting comfortably
- Compact size, practical for small spaces
- All surfaces are hygienic and easy to clean
- Suitable for all KERN analytical balances, precision balances and microscopes with the corresponding dimensions
- Overall dimensions, WxDxH
YPS-04: 400x450x60 mm
YPS-05: 565x450x60 mm
YPS-06: individual dimensions, according to your requirements
- Net weight approx.
YPS-04: 30 kg
YPS-05: 35 kg
YPS-06: on request

Ready for shipping in 2 working days.

Dispatch complete on pallet.

Please ask for dimensions, gross weight, shipping costs,

KERN YPS-04, € 760,-

KERN YPS-05, € 980,-

KERN YPS-06, on request



STANDARD

 2 DAYS



Roller Conveyor KERN YRO-01 / YRO-02 / YRO-03

Through the smooth-running KERN roller conveyor attachments, KERN YRO, you can convert your platform scale into a robust measuring system for rapid and flexible weight determination in conveyor applications.

Especially suitable for use in production and dispatch lines, where time means money. The goods or packages can either be weighed as they pass over the balance or, at fixed stations, heavy goods can easily be pushed onto the scale thanks to the roller conveyor and moved onto the connected roller conveyor.

- **1** Simply connect the roller conveyor attachment to a platform (e.g. KERN IFS, IXC, SXC, KBP, KFP) – done!
- Robust aluminium profile frame. The modular design means that you can easily disassemble it for cleaning or to replace individual components
- Smooth-running, hot-dip galvanised steel rollers with ball bearings
- Conductive rollers
- Suitable for use in dry environments
- Roller distance approx. 30 mm
- Direction of movement is lengthways

- Scope of delivery: 1 roller conveyor attachment (without scale)
- We are happy to adapt the roller conveyor to your scale, adjust the preload or switch-on tolerance, etc. Please ask for your individual offer, your personal KERN contact person will be happy to help you

| Model | Total dimensions W×D×H | Suitable for platforms with weighing plate sizes W×D | Total net weight approx. | Price excl. of VAT ex works € |
|--------|---------------------------|--|-----------------------------|--|
| KERN | mm | mm | kg | |
| YRO-01 | 405×305×130 | 400×300 | 6 | 830,- |
| YRO-02 | 505×405×130 | 500×400 | 9 | 870,- |
| YRO-03 | 655×505×130 | 650×500 | 12 | 1200,- |



17



TEST WEIGHTS

Weights yesterday and today

For centuries now, weight pieces have been used in scales for weighing procedures. This original purpose has now almost disappeared. Today, weights are used almost exclusively for adjusting and testing = calibration of electronic balances. They are now named "test weights" as this is their contemporary purpose.

Adjustment or calibration?

► **Adjusting** a balance means that you are intervening in the weighing system, to make sure that the display is set to show the correct nominal value. With ► **calibration** on the other hand, there is no intervention, you are testing whether the display is correct and documenting any deviation.

Testing, the right way!

The internationally valid norm OIML R111:2004 classifies test weights hierarchically in accuracy classes, where E1 is the most accurate and M3 is the least accurate weight class. With KERN you get the whole test weight range in all OIML accuracy classes E1, E2, F1, F2, M1, M2, M3.

As the test weight only becomes an ► **ISO 9000ff**-compliant test instrument when its accuracy has been proven, we offer the appropriate ► **DAkkS Calibration certificate** or verification certificate (in connection with a box) for all KERN test weights. For further details see DAkkS Calibration Service.

KERN offers you the appropriate test weight package for your balance, consisting of the test weight, box and DAkkS-calibration certificate, as proof of its accuracy. The best prerequisite for a correct adjustment or checking of your scales.

► **See the Glossary**







Classes of accuracy of test weights E, F, M and their general relation to the types of balances.

The appropriate OIML tolerance class for the test weight is selected based on the scale's resolution. The key factor for this is the scale's increment count:

$$\text{Increment count [n]} = \frac{\text{Maximum capacity [Max]}}{\text{Division value [d]}}$$

- E1 Test weights for customers who require a high degree of accuracy for the most demanding applications. For high-resolution balances with $d > 1,000,000$ Use recommended with DAkkS calibration certificate only.
- E2 Most accurate test weights for high resolution analytical balances of verification class I $\geq 100,000$ e
- F1 Test weights for analytical balances/precision balances for verification class I/II $\leq 100,000$ e
- F2 Test weights for precision balances of verification class II $\leq 30,000$ e
- M1 Test weights for industrial and commercial scales of verification class III $\leq 10,000$ e

The appropriate test weight for your new KERN balance can also be found directly in the accessories of the balance in our webshop.

| KERN DAkkS delivery times & shipping type | Total weight ≤ 30 kg (gross weight, incl. packaging) | Total weight > 30 kg (gross weight, incl. packaging) |
|---|--|--|
| DAkkS standard service Class E2 – M3 |  4 DAYS |  4 DAYS |
| DAkkS standard service Class E1, 1 mg – 500 mg and recalibration 1 g – 10 kg with a known volume |  10 DAYS |  10 DAYS |
| Class E1, ≥ 1 g, incl. volume determination (new weights) |  15 DAYS |  15 DAYS |
| Special weights, Newton weights, heavy duty weights, weight carriers, containers for individual weight sets etc. | on request | |

Just lean back – we have just the right test weight for your measuring device

KERN offers you a large range of OIML test weights, which you can use at any time to quickly and reliably check your measuring instrument. From milligram weights to tonne weights, from the classic OIML design to special weights which are specifically manufactured to your specifications, we can offer you just the right test weight, and naturally the weights have the relevant DAkkS calibration certificate or factory calibration certificate.

On the following pages you will see a selection of standard test weights for OIML error limit classes E1, E2, F1, F2, M1, M2, M3. We will be happy to manufacture special (large) weights, weight containers, Newton weights or weights with special weight values for you on request. Our test weights product specialist will be happy to give you expert, comprehensive advice.

Note: In our webshop you can conveniently select test weights for your scale that have been calculated and matched to your safety requirements and intended use – with or without calibration. We will be happy to determine the minimum sample quantity according to USP Chapter <41> and recommend a KERN Safety Set especially designed for your scale.



PREMIUM⁺ TEST WEIGHTS

Note: Our highly-accurate OIML test weights are also available as **PREMIUM⁺ test weights** for that extra level of safety. Thanks to the most modern manufacturing technology, these test weights can also be adjusted within the specified error limit classes (= tolerances).

I.e. this means that these **PREMIUM⁺ test weights** have a significantly longer service life, thanks this guaranteed positive tolerance. This is of particular benefit with intensive use of the test weights.

For all the details on this **PREMIUM⁺ service** please see www.kern-lab.com/premium+ or look at the weight you want in our online shop at www.kern-sohn.com

Marking – never lose track again!

With the large variety of test equipment used then it is essential that they are identified accurately. We can help you with this and mark your test weights according to your ideas by etching, with impact numbers or laser engraved. Whether it's letters, numbers, your logo, barcodes or something else – it's your choice.

Our product specialist "Test weights" will gladly help you with any questions about this service, prices, etc.



SAFELY LOOKED AFTER

KERN weight boxes made of polyoxymethylene (“POM”) – for the most demanding requirements in highly-sensitive environments such as laboratories and clean rooms

You can rely on the highest quality and safety when storing your KERN test weights for clean room areas. KERN weight boxes made of polyoxymethylene (“POM”) are secure and easy to clean and are essential aids in clean rooms, laboratories or production environments because they protect your test weights perfectly and this enables consistently accurate and reliable measurements.

The robust construction means that there are no edges or padding which could collect dirt. This means that the boxes are particularly easy to clean hygienically.

For test weights in weight classes from E1 to M1, KERN clean room boxes offer further advantages in addition to protection, in order to meet the highest requirements in terms of cleanliness and absence of contamination. They do not require maintenance and are resistant to a range of cleaning products, acids, alkalis, disinfectants and solvents. They can also be cleaned in thermo disinfectors without any problems. In addition, repeated disinfection and cleaning ensures that they meet the highest standards of the clean room environment.

Please note: Our clean room boxes are also available in an antistatic version on request – for additional safety in hazardous areas.



All the advantages of KERN clean room boxes at a glance:

- extremely stable and robust
- can be fully disinfected
- easy to clean
- without padding or edges which could collect dirt
- maintenance-free and long-lasting
- for maximum safety and measurement results

NEW



Convenient screw thread without edges which could trap dirt – KERN clean room boxes in detail

New from KERN: The practical test weight trolley KERN 313-112-400

The KERN transport case is your essential companion for a professional appearance. It offers you direct access at all times to your full set of weights, so that you can work quickly and efficiently. With this case, you can not only increase your productivity, but also leave a lasting impression on your customers. Suitable for all weights in classes E1 – M1, see *Test weights*

NEW



→ Do you have any special requirements?

High-quality weight boxes e.g. on request we can also manufacture boxes for rectangular weights or complete weight sets to suit your individual requirements. We will be happy to advise you.



Product Specialist
Test Weights
Taras Mikitisin
Tel. +49 7433 9933-143
mikitisin@kern-sohn.com

Our KERN weight cases at a glance:

| | | | | | | |
|---|---|---|---|--|---|---|
|  |  |  |  |  |  |  |
| for individual weights Plastic box | for individual weights Aluminium protected box | for individual weights Wooden box, lined / unlined | for individual weights Polyoxymethylene boxes POM, unlined | for weight sets Plastic case | for weight sets Aluminium protected case | for weight sets Wooden case, lined / unlined |

It's your choice!

To protect your test weights we can offer you an appropriate weight case. Choose the right box for your needs. You have the choice between plastic, aluminium protected, wood or polyoxymethylene. The available weight cases are shown as a symbol in the test weight tables on the following pages. This way you have all the materials, versions, sizes and prices at a glance, listed in a concise way.



On request only:
for weight sets
Clean room boxes POM (polyoxymethylene), unlined



It's so easy to order your suitable test weight



According to your safety requirements or the specifications of your QM system, you select the test weight with the appropriate weight value and the required tolerance.

We offer many test weights in different designs, giving you complete freedom to decide which test weights you want to use for your application. It goes without saying that all our test weights comply with the OIML R111:2004 directive.

To protect your high-quality test equipment, we offer you cases in various designs.

A DAkkS calibration certificate – the auditor's favourite! With this certificate you provide the standard-compliant proof of all important values of your test equipment and are on the safe side when operating and testing your measuring equipment.

| Weight | Tol +/- mg | Individual weights, compact shape | | Individual weights, knob shape | | Plastic box | | Aluminium protected box | | Wooden box | | DAkkS certificate | |
|--------|------------|-----------------------------------|------|--------------------------------|------|-------------|------|-------------------------|------|-------------|------|-------------------|------|
| | | KERN | € | KERN | € | KERN | € | KERN | € | KERN | € | KERN | € |
| 1 g | 0,03 | 316-01 | 41,- | 317-01 | 59,- | 317-020-400 | 4,80 | 317-010-600 | 14,- | 317-010-100 | 30,- | 962-331 | 33,- |
| 2 g | 0,04 | 316-02 | 41,- | 317-02 | 60,- | 317-020-400 | 4,80 | 317-020-600 | 17,- | 317-020-100 | 30,- | 962-332 | 33,- |
| 5 g | 0,05 | 316-03 | 43,- | 317-03 | 63,- | 317-030-400 | 4,80 | 317-030-600 | 15,- | 317-030-100 | 32,- | 962-333 | 33,- |
| 10 g | 0,06 | 316-04 | 44,- | 317-04 | 67,- | 317-040-400 | 4,80 | 317-040-600 | 15,- | 317-040-100 | 33,- | 962-334 | 33,- |
| 20 g | 0,08 | 316-05 | 47,- | 317-05 | 76,- | 317-050-400 | 4,80 | 317-050-600 | 15,- | 317-050-100 | 33,- | 962-335 | 33,- |
| 50 g | 0,10 | 316-06 | 53,- | 317-06 | 80,- | 317-060-400 | 4,80 | 317-060-600 | 15,- | 317-060-100 | 33,- | 962-336 | 33,- |

| Weight | Knob shape in plastic case | | Knob shape in aluminium protected case | | Knob shape in wooden case | | DAkkS certificate | |
|---------------|----------------------------|--------|--|-------|---------------------------|-------|-------------------|-------|
| | KERN | € | KERN | € | KERN | € | KERN | € |
| 1 mg - 500 mg | 338-22 | 159,- | 338-226 | 200,- | - | - | 962-450 | 118,- |
| 1 mg - 50 g | 333-024 | 390,- | 333-026 | 410,- | 333-02 | 410,- | 962-401 | 197,- |
| 1 mg - 100 g | 333-034 | 435,- | 333-036 | 450,- | 333-03 | 455,- | 962-402 | 210,- |
| 1 mg - 200 g | 333-044 | 510,- | 333-046 | 520,- | 333-04 | 520,- | 962-403 | 235,- |
| 1 mg - 500 g | 333-054 | 580,- | 333-056 | 600,- | 333-05 | 610,- | 962-404 | 245,- |
| 1 mg - 1 kg | 333-064 | 730,- | 333-066 | 750,- | 333-06 | 750,- | 962-405 | 255,- |
| 1 mg - 2 kg | 333-074 | 1030,- | 333-076 | - | - | - | - | - |

Selection of the appropriate test weight for your balance

A balance can never be more accurate than the test weight that is used to adjust it, it all depends on its tolerance. **The accuracy of the test weight should correspond to the readout [d] of the balance, or rather be more precise.**

Nominal test weight value is shown in adjust mode "CAL" in the balance display. Given a choice, the heaviest weight is the most suitable for accurate measurement.

Once accuracy and nominal test weight value are specified, the suitable test weight is selected according to the tolerances "Tol" of the individual accuracy classes E2 – M3, see column "Tol ± mg" at the respective weight.

Example:





Balance with weighing range [Max] 2000 g = 2 kg and readout [d] = 0,01 g = 10 mg

- The accuracy of the required test weight is determined by readout [d]: max. tolerance ± 10 mg.
- Displayed weight size on "CAL" mode: 1000 g or 2000 g. The required test weight has a 2 kg weight size.
- Suitable test weights with ± 10 mg tolerance and 2 kg weight size, can be found in accuracy class F1. KERN-No 326-12 or KERN-No 327-12.

Exception: analytical balances (readout [d] ≤ 0,1 mg):

E1 test weights are recommended. Depending on the safety requirements, E2 test weights with a DAkkS calibration certificate will also be sufficient.

From finely turned to polished stainless steel – the right test weight for every situation

| Test weight |  |  |  |  |  |
|--|--|--|---|--|--|
| Features | → Knob shape with lifting knob, polished stainless steel | Compact shape with carrying grip, polished stainless steel | Knob shape with lifting knob, polished stainless steel | ECO shape, polished stainless steel | Knob shape with lifting knob, finely turned stainless steel |
| Conforms to OIML:R111 | ↓ yes | yes | yes | yes | yes |
| Available classes | E1, E2 | E2 | F1 | F1 | F2, M1 |
| Upper surface | polished | polished | polished | polished | finely turned |
| Material | Stainless steel | Stainless steel | Stainless steel | Stainless steel | Stainless steel |
| Adjusting cavity | no | no | yes | yes, from 50 g, readjustment can only be carried out by KERN | yes, from 20 g |
| Marking (Milligram weights, generally none) | none | none | Nominal value, etched | Nominal value, etched | F2: Class + nominal value, etched; M1: Class + nominal value, adopted |
| Verification possible | yes (E2) | no | yes | no | yes (M1) |
| Checking equipment for verification purposes | approved (E2) | approved | approved | approved | approved (M1) |
| Ideal as checking equipment in QM systems (e.g. ISO 9000 ff) | yes | yes | yes | yes | yes |
| Benefits | <ul style="list-style-type: none"> • High-quality test weight for analytical and precision balances • Highly-refined surface • Ideal shape of the top for good grip | <ul style="list-style-type: none"> • Affordable test weight for analytical and precision balances • Highly refined surface | <ul style="list-style-type: none"> • Ideal, high-quality test weight for precision balances • No visible adjustment chamber • High long-term stability • Ideal shape of the top for good grip | <ul style="list-style-type: none"> • Affordable test weight for analytical and precision balances • Highly refined surface • Optimum shape of the top for good grip | <ul style="list-style-type: none"> • Ideal test weight for commercial and industrial scales • Ideal shape of the top for good grip |

Composition table, valid for all KERN test weight sets from 1 mg

| Individual weights per set | 1 | 2 | 2 | 5 | 10 | 20 | 20 | 50 | 100 | 200 | 200 | 500 | 1 | 2 | 2 | 5 | 10 | | | | |
|----------------------------|-----------------|-------|---|---|----|----|----|----|-----|-----|-----|-----|---|---|---|---|----|----|--|--|--|
| Test weight set | mg | | | | | | | | | | | | g | | | | | kg | | | |
| 1 mg–500 mg | Σ = 1,11 g | | | | | | | | | | | | | | | | | | | | |
| 1 mg–50 g | Σ = 111,11 g | | | | | | | | | | | | | | | | | | | | |
| 1 mg–100 g | Σ = 211,11 g | | | | | | | | | | | | | | | | | | | | |
| 1 mg–200 g | Σ = 611,11 g | | | | | | | | | | | | | | | | | | | | |
| 1 mg–500 g | Σ = 1.111,11 g | | | | | | | | | | | | | | | | | | | | |
| 1 mg–1 kg | Σ = 2.111,11 g | | | | | | | | | | | | | | | | | | | | |
| 1 mg–2 kg | Σ = 6.111,11 g | | | | | | | | | | | | | | | | | | | | |
| 1 mg–5 kg | Σ = 11.111,11 g | | | | | | | | | | | | | | | | | | | | |
| 1 mg–10 kg | Σ = 21.111,11 g | | | | | | | | | | | | | | | | | | | | |

The key points from the OIML norm R111:2004

OIML (Organisation Internationale de Métrologie Légale) has established the exact metrological requirements for weights in verified applications in approx. 100 states all over the world.

The OIML guideline R111 (2004 Edition) for weights relates to sizes 1 mg – 5000 kg. Statements are made on the accuracy, materials, geometric shape, marking and storage of the weights.

Error limits for weights of classes E1 to M3

The error limit classes are in fixed hierarchical levels in the proportion of 1:3, where E1 is the most accurate and M3 is the least accurate weight class. When testing weights with other weights, the correct test class is the next highest class.

Error limit classes (= tolerances)

The values given in the table below (tolerances ± ... mg) are the respective permitted fabrication tolerances.

They are to be equal to the

- ▶ **measuring uncertainty** of the weight, if no
- ▶ **DAkkS calibration certificate** is available.

Conventional mass

The problem is the air buoyancy, which makes the weight appear lighter. In order to avoid this “distortion” in daily use, all weights are adjusted to the unit specifications as given in R111, e.g. it is accepted that: material density of the weights is 8000 kg/m³, air density is 1.2 kg/m³ and measuring temperature is 20 °C.

KERN test weights:

Unless otherwise specified, they conform to OIML R111:2004 in every detail.

▶ **See the Glossary**

Nominal value OIML R111:2004 Maximum permissible errors for weights = permissible tolerances “Tol ± mg”

| ↓ | E1 | E2 | F1 | F2 | M1 | M2 | M3 |
|-----------------|------------|------------|------------|------------|------------|------------|------------|
| 1 mg | ± 0,003 mg | ± 0,006 mg | ± 0,020 mg | ± 0,06 mg | ± 0,20 mg | - | - |
| 2 mg | ± 0,003 mg | ± 0,006 mg | ± 0,020 mg | ± 0,06 mg | ± 0,20 mg | - | - |
| 5 mg | ± 0,003 mg | ± 0,006 mg | ± 0,020 mg | ± 0,06 mg | ± 0,20 mg | - | - |
| 10 mg | ± 0,003 mg | ± 0,008 mg | ± 0,025 mg | ± 0,08 mg | ± 0,25 mg | - | - |
| 20 mg | ± 0,003 mg | ± 0,010 mg | ± 0,03 mg | ± 0,10 mg | ± 0,3 mg | - | - |
| 50 mg | ± 0,004 mg | ± 0,012 mg | ± 0,04 mg | ± 0,12 mg | ± 0,4 mg | - | - |
| 100 mg | ± 0,005 mg | ± 0,016 mg | ± 0,05 mg | ± 0,16 mg | ± 0,5 mg | ± 1,6 mg | - |
| 200 mg | ± 0,006 mg | ± 0,020 mg | ± 0,06 mg | ± 0,20 mg | ± 0,6 mg | ± 2,0 mg | - |
| 500 mg | ± 0,008 mg | ± 0,025 mg | ± 0,08 mg | ± 0,25 mg | ± 0,8 mg | ± 2,5 mg | - |
| 1 g | ± 0,010 mg | ± 0,03 mg | ± 0,10 mg | ± 0,3 mg | ± 1,0 mg | ± 3,0 mg | ± 10 mg |
| 2 g | ± 0,012 mg | ± 0,04 mg | ± 0,12 mg | ± 0,4 mg | ± 1,2 mg | ± 4,0 mg | ± 12 mg |
| 5 g | ± 0,016 mg | ± 0,05 mg | ± 0,16 mg | ± 0,5 mg | ± 1,6 mg | ± 5,0 mg | ± 16 mg |
| 10 g | ± 0,020 mg | ± 0,06 mg | ± 0,20 mg | ± 0,6 mg | ± 2,0 mg | ± 6,0 mg | ± 20 mg |
| 20 g | ± 0,025 mg | ± 0,08 mg | ± 0,25 mg | ± 0,8 mg | ± 2,5 mg | ± 8,0 mg | ± 25 mg |
| 50 g | ± 0,03 mg | ± 0,10 mg | ± 0,3 mg | ± 1,0 mg | ± 3,0 mg | ± 10 mg | ± 30 mg |
| 100 g | ± 0,05 mg | ± 0,16 mg | ± 0,5 mg | ± 1,6 mg | ± 5,0 mg | ± 16 mg | ± 50 mg |
| 200 g | ± 0,10 mg | ± 0,3 mg | ± 1,0 mg | ± 3,0 mg | ± 10 mg | ± 30 mg | ± 100 mg |
| 500 g | ± 0,25 mg | ± 0,8 mg | ± 2,5 mg | ± 8,0 mg | ± 25 mg | ± 80 mg | ± 250 mg |
| 1 kg | ± 0,5 mg | ± 1,6 mg | ± 5,0 mg | ± 16 mg | ± 50 mg | ± 160 mg | ± 500 mg |
| 2 kg | ± 1,0 mg | ± 3,0 mg | ± 10 mg | ± 30 mg | ± 100 mg | ± 300 mg | ± 1 000 mg |
| 5 kg | ± 2,5 mg | ± 8,0 mg | ± 25 mg | ± 80 mg | ± 250 mg | ± 800 mg | ± 2 500 mg |
| 10 kg | ± 5,0 mg | ± 16 mg | ± 50 mg | ± 160 mg | ± 500 mg | ± 1 600 mg | ± 5 000 mg |
| 20 kg | ± 10 mg | ± 30 mg | ± 100 mg | ± 300 mg | ± 1 000 mg | ± 3 000 mg | ± 10 g |
| 50 kg | ± 25 mg | ± 80 mg | ± 250 mg | ± 800 mg | ± 2 500 mg | ± 8 000 mg | ± 25 g |
| 100 kg | - | ± 160 mg | ± 500 mg | ± 1 600 mg | ± 5 000 mg | ± 16 g | ± 50 g |
| 200 kg | - | ± 300 mg | ± 1 000 mg | ± 3 000 mg | ± 10 g | ± 30 g | ± 100 g |
| 500 kg | - | ± 800 mg | ± 2 500 mg | ± 8 000 mg | ± 25 g | ± 80 g | ± 250 g |
| 1 000 kg | - | ± 1 600 mg | ± 5 000 mg | ± 16 g | ± 50 g | ± 160 g | ± 500 g |
| 2 000 kg | - | - | ± 10 g | ± 30 g | ± 100 g | ± 300 g | ± 1 000 g |
| 5 000 kg | - | - | ± 25 g | ± 80 g | ± 250 g | ± 800 g | ± 2 500 g |

TEST WEIGHTS AND BOXES CLASS E1

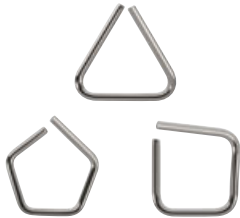

Milligram weights, wire shape



Individual weights, knob shape



Wooden box, for milligram weights



Plastic box, lined,
for individual
weights ≤ 50 g



Plastic box, lined,
for individual
weights ≥ 100 g



Wooden box, lined,
for individual weights ≤ 500 g



Wooden box, lined,
for individual weights ≥ 1 kg



Milligram weight
set in plastic case
(308-42)



Milligram weight
set in aluminium
protected case,
lined (308-426)



Plastic case, lined, for weight sets,
compact shape/knob shape



Aluminium protected case, lined,
for weight sets, knob shape



Wooden case, lined,
for weight sets, knob shape



Class E1 · Milligram weights, wire shape

Test weight material: stainless steel

| Weight | Tol +/- mg | Milligram weight, wire shape | | Plastic box | | Aluminium protected box | | Wooden box | | DAkkS certificate | |
|--------|------------|------------------------------|------|-------------|-----|-------------------------|------|-------------|------|-------------------|------|
| | | KERN | € | KERN | € | KERN | € | KERN | € | KERN | € |
| 1 mg | 0,003 | 308-31 | 89,- | 347-009-400 | 2,- | 317-009-600 | 13,- | 338-090-200 | 34,- | 962-251 | 69,- |
| 2 mg | 0,003 | 308-32 | 89,- | 347-009-400 | 2,- | 317-009-600 | 13,- | 338-090-200 | 34,- | 962-252 | 69,- |
| 5 mg | 0,003 | 308-33 | 89,- | 347-009-400 | 2,- | 317-009-600 | 13,- | 338-090-200 | 34,- | 962-253 | 69,- |
| 10 mg | 0,003 | 308-34 | 89,- | 347-009-400 | 2,- | 317-009-600 | 13,- | 338-090-200 | 34,- | 962-254 | 69,- |
| 20 mg | 0,003 | 308-35 | 89,- | 347-009-400 | 2,- | 317-009-600 | 13,- | 338-090-200 | 34,- | 962-255 | 69,- |
| 50 mg | 0,004 | 308-36 | 89,- | 347-009-400 | 2,- | 317-009-600 | 13,- | 338-090-200 | 34,- | 962-256 | 69,- |
| 100 mg | 0,005 | 308-37 | 89,- | 347-009-400 | 2,- | 317-009-600 | 13,- | 338-090-200 | 34,- | 962-257 | 69,- |
| 200 mg | 0,006 | 308-38 | 89,- | 347-009-400 | 2,- | 317-009-600 | 13,- | 338-090-200 | 34,- | 962-258 | 69,- |
| 500 mg | 0,008 | 308-39 | 89,- | 347-009-400 | 2,- | 317-009-600 | 13,- | 338-090-200 | 34,- | 962-259 | 69,- |

Class E1 · Individual weights, knob shape

Test weight material: stainless steel polished

| Weight | Tol +/- mg | Individual weight, knob shape | | Plastic box | | Aluminium protected box | | Wooden box | | DAkkS certificate Initial calibration* | | DAkkS certificate Recalibration | |
|--------|------------|-------------------------------|--------|-------------|------|-------------------------|-------|-------------|-------|--|--------|---------------------------------|-------|
| | | KERN | € | KERN | € | KERN | € | KERN | € | KERN | € | KERN | € |
| 1 g | 0,010 | 307-01 | 83,- | 317-020-400 | 4,80 | 317-010-600 | 13,- | 317-010-100 | 32,- | 963-231 | 250,- | 962-231 R | 82,- |
| 2 g | 0,012 | 307-02 | 89,- | 317-020-400 | 4,80 | 317-020-600 | 15,- | 317-020-100 | 30,- | 963-232 | 250,- | 962-232 R | 82,- |
| 5 g | 0,016 | 307-03 | 90,- | 317-030-400 | 4,80 | 317-030-600 | 14,- | 317-030-100 | 32,- | 963-233 | 250,- | 962-233 R | 82,- |
| 10 g | 0,020 | 307-04 | 97,- | 317-040-400 | 4,80 | 317-040-600 | 13,- | 317-040-100 | 30,- | 963-234 | 250,- | 962-234 R | 82,- |
| 20 g | 0,025 | 307-05 | 100,- | 317-050-400 | 4,80 | 317-050-600 | 13,- | 317-050-100 | 31,- | 963-235 | 250,- | 962-235 R | 82,- |
| 50 g | 0,030 | 307-06 | 118,- | 317-060-400 | 6,30 | 317-060-600 | 12,- | 317-060-100 | 35,- | 963-236 | 250,- | 962-236 R | 82,- |
| 100 g | 0,050 | 307-07 | 145,- | 317-070-400 | 7,80 | 317-070-600 | 13,- | 317-070-100 | 35,- | 963-237 | 250,- | 962-237 R | 82,- |
| 200 g | 0,100 | 307-08 | 186,- | 317-080-400 | 7,20 | 317-080-600 | 13,- | 317-080-100 | 39,- | 963-238 | 250,- | 962-238 R | 82,- |
| 500 g | 0,250 | 307-09 | 270,- | 317-090-400 | 8,70 | 317-090-600 | 17,- | 317-090-100 | 46,- | 963-239 | 250,- | 962-239 R | 82,- |
| 1 kg | 0,500 | 307-11 | 395,- | 317-110-400 | 10,- | 317-110-600 | 25,- | 317-110-100 | 61,- | 963-241 | 250,- | 962-241 R | 82,- |
| 2 kg | 1,000 | 307-12 | 570,- | 317-120-400 | 13,- | 317-120-600 | 29,- | 317-120-100 | 68,- | 963-242 | 570,- | 962-242 R | 101,- |
| 5 kg | 2,500 | 307-13 | 1020,- | 317-130-400 | 27,- | 317-130-600 | 53,- | 317-130-100 | 101,- | 963-243 | 570,- | 962-243 R | 101,- |
| 10 kg | 5,000 | 307-14 | 1640,- | 317-140-400 | 25,- | 317-140-600 | 75,- | 317-140-100 | 123,- | 963-244 | 570,- | 962-244 R | 101,- |
| 20 kg | 10,000 | 307-15 | 4280,- | - | - | 317-150-600 | 105,- | 317-150-100 | 580,- | 963-245 | 1320,- | 962-245 R | 760,- |
| 50 kg | 25,000 | 307-16 | 8190,- | - | - | 317-160-600 | 305,- | 317-160-100 | 710,- | 963-246 | 1540,- | 962-246 R | 840,- |

* For E1 weights > 1g at the point of DAkkS initial calibration, a volume determination will be carried out in accordance with OIML:R111. When recalibrating according to DAkkS, this is not required.

Class E1 · Weight sets, knob shape

Test weight material: stainless steel polished

| Weight set | Knob shape in plastic case | | Knob shape in aluminium protected case | | Knob shape in wooden case | | DAkkS certificate Initial calibration* | | DAkkS certificate Recalibration | |
|---------------|----------------------------|--------|--|--------|---------------------------|--------|--|--------|---------------------------------|--------|
| | KERN | € | KERN | € | KERN | € | KERN | € | KERN | € |
| 1 mg - 500 mg | 308-42 | 1130,- | 308-426 | 1380,- | - | - | 962-250 | 450,- | 962-250 R | 530,- |
| 1 mg - 50 g | 303-024 | 1930,- | 303-026 | 1830,- | 303-02 | 1970,- | 963-201 | 1440,- | 962-201 R | 890,- |
| 1 mg - 100 g | 303-034 | 2010,- | 303-036 | 1980,- | 303-03 | 2000,- | 963-202 | 1570,- | 962-202 R | 900,- |
| 1 mg - 200 g | 303-044 | 2250,- | 303-046 | 2270,- | 303-04 | 2310,- | 963-203 | 1800,- | 962-203 R | 990,- |
| 1 mg - 500 g | 303-054 | 2590,- | 303-056 | 2610,- | 303-05 | 2650,- | 963-204 | 1920,- | 962-204 R | 1030,- |
| 1 mg - 1 kg | 303-064 | 3140,- | 303-066 | 3260,- | 303-06 | 3200,- | 963-205 | 2040,- | 962-205 R | 1110,- |
| 1 mg - 2 kg | 303-074 | 4260,- | 303-076 | 4370,- | 303-07 | 4340,- | 963-206 | 2660,- | 962-206 R | 1180,- |
| 1 mg - 5 kg | 303-084 | 5270,- | 303-086 | 5660,- | 303-08 | 5460,- | 963-207 | 2980,- | 962-207 R | 1230,- |
| 1 mg - 10 kg | - | - | 303-096 | 6860,- | 303-09 | 7170,- | 963-208 | 3390,- | 962-208 R | 1270,- |
| 1 g - 50 g | 304-024 | 840,- | 304-026 | 620,- | 304-02 | 900,- | 963-215 | 1040,- | 962-215 R | 385,- |
| 1 g - 100 g | 304-034 | 980,- | 304-036 | 1130,- | 304-03 | 1040,- | 963-216 | 1130,- | 962-216 R | 420,- |
| 1 g - 200 g | 304-044 | 1350,- | 304-046 | 1500,- | 304-04 | 1410,- | 963-217 | 1380,- | 962-217 R | 500,- |
| 1 g - 500 g | 304-054 | 1610,- | 304-056 | 1780,- | 304-05 | 1740,- | 963-218 | 1500,- | 962-218 R | 550,- |
| 1 g - 1 kg | 304-064 | 2050,- | 304-066 | 2130,- | 304-06 | 2120,- | 963-219 | 1650,- | 962-219 R | 590,- |
| 1 g - 2 kg | 304-074 | 3200,- | 304-076 | 3330,- | 304-07 | 3300,- | 963-220 | 2310,- | 962-220 R | 680,- |
| 1 g - 5 kg | 304-084 | 4210,- | 304-086 | 4620,- | 304-08 | 4420,- | 963-221 | 2700,- | 962-221 R | 700,- |
| 1 g - 10 kg | - | - | 304-096 | 5820,- | 304-09 | 6120,- | 963-222 | 3150,- | 962-222 R | 760,- |

TEST WEIGHTS AND BOXES CLASS E2



NEW

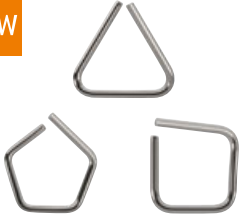

Milligram weights, wire shape



Milligram weights, flat polygonal sheet



Individual weights, compact shape



Individual weights, knob shape



Plastic box, lined, for individual weights ≤ 50 g



Plastic box, lined, for individual weights ≥ 100 g



Aluminium protected box, lined, for individual weights



Wooden box, lined, for individual weights ≤ 500 g



Wooden box, lined, for individual weights ≥ 1 kg



Milligram weight set in plastic case (318-22)



Milligram weight set in aluminium protected case, lined (318-226)



Plastic case, lined, for weight sets, compact shape/knob shape



Aluminium protected case, lined, for weight sets, compact shape/knob shape



Wooden case, lined, for weight sets, compact shape/knob shape

NEW Class E2 · Milligram weights, wire shape

Test weight material: stainless steel

| Weight | Tol +/- mg | Milligram weight, flat polygonal sheet | | Plastic box | | Aluminium protected box | | Wooden box | | DAkkS certificate | |
|---------------|------------|--|-------|-------------|-----|-------------------------|------|-------------|------|-------------------|------|
| | | KERN | € | KERN | € | KERN | € | KERN | € | KERN | € |
| 1 mg | 0,006 | 318-31 | 51,- | 347-009-400 | 2,- | 317-009-600 | 13,- | 338-090-200 | 34,- | 962-351 | 34,- |
| 2 mg | 0,006 | 318-32 | 51,- | 347-009-400 | 2,- | 317-009-600 | 13,- | 338-090-200 | 34,- | 962-352 | 34,- |
| 5 mg | 0,006 | 318-33 | 51,- | 347-009-400 | 2,- | 317-009-600 | 13,- | 338-090-200 | 34,- | 962-353 | 34,- |
| 10 mg | 0,008 | 318-34 | 51,- | 347-009-400 | 2,- | 317-009-600 | 13,- | 338-090-200 | 34,- | 962-354 | 34,- |
| 20 mg | 0,010 | 318-35 | 51,- | 347-009-400 | 2,- | 317-009-600 | 13,- | 338-090-200 | 34,- | 962-355 | 34,- |
| 50 mg | 0,012 | 318-36 | 51,- | 347-009-400 | 2,- | 317-009-600 | 13,- | 338-090-200 | 34,- | 962-356 | 34,- |
| 100 mg | 0,016 | 318-37 | 51,- | 347-009-400 | 2,- | 317-009-600 | 13,- | 338-090-200 | 34,- | 962-357 | 34,- |
| 200 mg | 0,020 | 318-38 | 51,- | 347-009-400 | 2,- | 317-009-600 | 13,- | 338-090-200 | 34,- | 962-358 | 34,- |
| 500 mg | 0,025 | 318-39 | 51,- | 347-009-400 | 2,- | 317-009-600 | 13,- | 338-090-200 | 34,- | 962-359 | 34,- |
| 1 mg - 500 mg | - | 318-42 | 610,- | - | - | - | - | - | - | - | - |

Class E2 · Milligram weights, flat polygonal sheet

Test weight material: stainless steel

| Weight | Tol +/- mg | Milligram weight, flat polygonal sheet | | Plastic box | | Aluminium protected box | | Wooden box | | DAkkS certificate | |
|--------|------------|--|------|-------------|-----|-------------------------|------|-------------|------|-------------------|------|
| | | KERN | € | KERN | € | KERN | € | KERN | € | KERN | € |
| 1 mg | 0,006 | 318-01 | 28,- | 347-009-400 | 2,- | 317-009-600 | 13,- | 338-090-200 | 34,- | 962-351 | 34,- |
| 2 mg | 0,006 | 318-02 | 28,- | 347-009-400 | 2,- | 317-009-600 | 13,- | 338-090-200 | 34,- | 962-352 | 34,- |
| 5 mg | 0,006 | 318-03 | 28,- | 347-009-400 | 2,- | 317-009-600 | 13,- | 338-090-200 | 34,- | 962-353 | 34,- |
| 10 mg | 0,008 | 318-04 | 28,- | 347-009-400 | 2,- | 317-009-600 | 13,- | 338-090-200 | 34,- | 962-354 | 34,- |
| 20 mg | 0,010 | 318-05 | 28,- | 347-009-400 | 2,- | 317-009-600 | 13,- | 338-090-200 | 34,- | 962-355 | 34,- |
| 50 mg | 0,012 | 318-06 | 28,- | 347-009-400 | 2,- | 317-009-600 | 13,- | 338-090-200 | 34,- | 962-356 | 34,- |
| 100 mg | 0,016 | 318-07 | 28,- | 347-009-400 | 2,- | 317-009-600 | 13,- | 338-090-200 | 34,- | 962-357 | 34,- |
| 200 mg | 0,020 | 318-08 | 28,- | 347-009-400 | 2,- | 317-009-600 | 13,- | 338-090-200 | 34,- | 962-358 | 34,- |
| 500 mg | 0,025 | 318-09 | 28,- | 347-009-400 | 2,- | 317-009-600 | 13,- | 338-090-200 | 34,- | 962-359 | 34,- |

Class E2 · Individual weights, compact shape or knob shape

Test weight material: stainless steel polished

| Weight | Tol +/- mg | Individual weights, compact shape | | Individual weights, knob shape | | Plastic box | | Aluminium protected box | | Wooden box | | DAkkS certificate | |
|--------|------------|-----------------------------------|-------|--------------------------------|--------|-------------|------|-------------------------|-------|-------------|-------|-------------------|------|
| | | KERN | € | KERN | € | KERN | € | KERN | € | KERN | € | KERN | € |
| 1 g | 0,03 | 316-01 | 41,- | 317-01 | 51,- | 317-020-400 | 4,80 | 317-010-600 | 13,- | 317-010-100 | 32,- | 962-331 | 34,- |
| 2 g | 0,04 | 316-02 | 41,- | 317-02 | 53,- | 317-020-400 | 4,80 | 317-020-600 | 15,- | 317-020-100 | 30,- | 962-332 | 34,- |
| 5 g | 0,05 | 316-03 | 43,- | 317-03 | 55,- | 317-030-400 | 4,80 | 317-030-600 | 14,- | 317-030-100 | 32,- | 962-333 | 34,- |
| 10 g | 0,06 | 316-04 | 44,- | 317-04 | 57,- | 317-040-400 | 4,80 | 317-040-600 | 13,- | 317-040-100 | 30,- | 962-334 | 34,- |
| 20 g | 0,08 | 316-05 | 47,- | 317-05 | 64,- | 317-050-400 | 4,80 | 317-050-600 | 13,- | 317-050-100 | 31,- | 962-335 | 34,- |
| 50 g | 0,10 | 316-06 | 53,- | 317-06 | 71,- | 317-060-400 | 6,30 | 317-060-600 | 12,- | 317-060-100 | 35,- | 962-336 | 34,- |
| 100 g | 0,16 | 316-07 | 59,- | 317-07 | 80,- | 317-070-400 | 7,80 | 317-070-600 | 13,- | 317-070-100 | 35,- | 962-337 | 42,- |
| 200 g | 0,30 | 316-08 | 69,- | 317-08 | 106,- | 317-080-400 | 7,20 | 317-080-600 | 13,- | 317-080-100 | 39,- | 962-338 | 42,- |
| 500 g | 0,80 | 316-09 | 102,- | 317-09 | 156,- | 317-090-400 | 8,70 | 317-090-600 | 17,- | 317-090-100 | 46,- | 962-339 | 42,- |
| 1 kg | 1,60 | 316-11 | 130,- | 317-11 | 215,- | 317-110-400 | 10,- | 317-110-600 | 25,- | 317-110-100 | 61,- | 962-341 | 42,- |
| 2 kg | 3,00 | 316-12 | 210,- | 317-12 | 315,- | 317-120-400 | 13,- | 317-120-600 | 29,- | 317-120-100 | 68,- | 962-342 | 52,- |
| 5 kg | 8,00 | 316-13 | 405,- | 317-13 | 510,- | 317-130-400 | 27,- | 317-130-600 | 53,- | 317-130-100 | 101,- | 962-343 | 52,- |
| 10 kg | 16,00 | 316-14 | 700,- | 317-14 | 780,- | 317-140-400 | 25,- | 317-140-600 | 75,- | 317-140-100 | 123,- | 962-344 | 52,- |
| 20 kg | 30,00 | - | - | 317-15 | 2330,- | - | - | 317-150-600 | 105,- | 317-150-100 | 580,- | 962-345 | 67,- |
| 50 kg | 80,00 | - | - | 317-16 | 4810,- | - | - | 317-160-600 | 305,- | 317-160-100 | 710,- | 962-346 | 77,- |

Tip:

Our highly-accurate OIML test weights are also available as **PREMIUM+ weights** for that extra level of safety. See all details page 187 or on www.kern-lab.com/premium+

Class E2 · Weight sets, compact shape

Test weight material: Milligram weights stainless steel, individual weights: polished stainless steel

| Weight sets | Compact shape in plastic case | | Compact shape in aluminium protected case | | DAkkS certificate | |
|---------------|-------------------------------|---------------|---|---------------|-------------------|--------------|
| | KERN | € | KERN | € | KERN | € |
| 1 mg - 500 mg | 318-22 | 270,- | 318-226 | 400,- | 962-350 | 230,- |
| 1 g - 50 g | 312-024 | 465,- | 312-026 | 435,- | 962-315 | 157,- |
| 1 g - 100 g | 312-034 | 520,- | 312-036 | 500,- | 962-316 | 187,- |
| 1 g - 200 g | 312-044 | 650,- | 312-046 | 630,- | 962-317 | 245,- |
| 1 g - 500 g | 312-054 | 750,- | 312-056 | 730,- | 962-318 | 285,- |
| 1 g - 1 kg | 312-064 | 970,- | 312-066 | 970,- | 962-319 | 315,- |
| 1 g - 2 kg | 312-074 | 1350,- | 312-076 | 1400,- | 962-320 | 385,- |
| 1 g - 5 kg | 312-084 | 1780,- | 312-086 | 1870,- | 962-321 | 440,- |
| 1 g - 10 kg | - | - | 312-096 | 2510,- | 962-322 | 475,- |

Class E2 · Weight sets, knob shape

Test weight material: Milligram weights stainless steel, individual weights: polished stainless steel

| Weight sets | Knob shape in plastic case | | Knob shape in aluminium protected case | | Knob shape in wooden case | | DAkkS certificate | |
|---------------|----------------------------|---------------|--|---------------|---------------------------|---------------|-------------------|--------------|
| | KERN | € | KERN | € | KERN | € | KERN | € |
| 1 mg - 500 mg | 318-22 | 270,- | 318-226 | 400,- | | | 962-350 | 230,- |
| 1 mg - 50 g | 313-024 | 880,- | 313-026 | 760,- | 313-02 | 930,- | 962-301 | 380,- |
| 1 mg - 100 g | 313-034 | 960,- | 313-036 | 1030,- | 313-03 | 1010,- | 962-302 | 410,- |
| 1 mg - 200 g | 313-044 | 1220,- | 313-046 | 1030,- | 313-04 | 1220,- | 962-303 | 480,- |
| 1 mg - 500 g | 313-054 | 1360,- | 313-056 | 1390,- | 313-05 | 1440,- | 962-304 | 510,- |
| 1 mg - 1 kg | 313-064 | 1620,- | 313-066 | 1700,- | 313-06 | 1690,- | 962-305 | 540,- |
| 1 mg - 2 kg | 313-074 | 2240,- | 313-076 | 2360,- | 313-07 | 2330,- | 962-306 | 600,- |
| 1 mg - 5 kg | 313-084 | 2920,- | 313-086 | 2910,- | 313-08 | 2940,- | 962-307 | 640,- |
| 1 mg - 10 kg | - | - | 313-096 | 3950,- | 313-09 | 3790,- | 962-308 | 680,- |
| 1 g - 50 g | 314-024 | 550,- | 314-026 | 460,- | 314-02 | 600,- | 962-315 | 157,- |
| 1 g - 100 g | 314-034 | 620,- | 314-036 | 710,- | 314-03 | 690,- | 962-316 | 187,- |
| 1 g - 200 g | 314-044 | 830,- | 314-046 | 900,- | 314-04 | 900,- | 962-317 | 245,- |
| 1 g - 500 g | 314-054 | 1070,- | 314-056 | 1100,- | 314-05 | 1110,- | 962-318 | 285,- |
| 1 g - 1 kg | 314-064 | 1290,- | 314-066 | 1380,- | 314-06 | 1360,- | 962-319 | 315,- |
| 1 g - 2 kg | 314-074 | 1910,- | 314-076 | 2040,- | 314-07 | 2000,- | 962-320 | 385,- |
| 1 g - 5 kg | 314-084 | 2410,- | 314-086 | 2590,- | 314-08 | 2620,- | 962-321 | 440,- |
| 1 g - 10 kg | - | - | 314-096 | 3630,- | 314-09 | 3460,- | 962-322 | 475,- |

Tip:

Our highly-accurate OIML test weights are also available as **PREMIUM+ weights** for that extra level of safety. See all details page 187 or on www.kern-lab.com/premium+

TEST WEIGHTS AND BOXES CLASS F1



NEW



Milligram weights,
wire shape



Milligram weights,
flat polygonal sheet



Individual weights/
Weight sets,
ECO shape



Individual weights/
Weight sets,
knob shape



Test weights (10 – 50 kg),
polished stainless steel,
KERN 327-141 ff,
optional: Wooden box



Block weight,
polished stainless steel



Plastic box, lined, for
• individual weights \leq 200 g
• individual weights \geq 500 g



Aluminium protected box, lined,
for individual weights



Wooden box, lined, for
• individual weights \leq 500 g
• individual weights \geq 1 kg



Milligram weight
set in plastic case
(328-22)



Milligram weight
set in aluminium
protected case,
lined (328-226)



Plastic case, lined for weight sets,
ECO shape/knob shape



Aluminium protected case, lined,
for weight sets ECO shape/
knob shape



Wooden case, lined, for weight sets
ECO shape/knob shape

NEW Class F1 · Milligram weights, wire shape

Test weight material: stainless steel

| Weight | Tol +/- mg | Milligram weight, flat polygonal sheet | | Plastic box | | Aluminium protected box | | Wooden box | | DAkkS certificate | |
|---------------|------------|--|-------|-------------|-----|-------------------------|------|-------------|------|-------------------|------|
| | | KERN | € | KERN | € | KERN | € | KERN | € | KERN | € |
| 1 mg | 0,02 | 328-31 | 21,- | 347-009-400 | 2,- | 317-009-600 | 13,- | 338-090-200 | 34,- | 962-451 | 22,- |
| 2 mg | 0,02 | 328-32 | 21,- | 347-009-400 | 2,- | 317-009-600 | 13,- | 338-090-200 | 34,- | 962-452 | 22,- |
| 5 mg | 0,02 | 328-33 | 21,- | 347-009-400 | 2,- | 317-009-600 | 13,- | 338-090-200 | 34,- | 962-453 | 22,- |
| 10 mg | 0,025 | 328-34 | 21,- | 347-009-400 | 2,- | 317-009-600 | 13,- | 338-090-200 | 34,- | 962-454 | 22,- |
| 20 mg | 0,03 | 328-35 | 21,- | 347-009-400 | 2,- | 317-009-600 | 13,- | 338-090-200 | 34,- | 962-455 | 22,- |
| 50 mg | 0,04 | 328-36 | 21,- | 347-009-400 | 2,- | 317-009-600 | 13,- | 338-090-200 | 34,- | 962-456 | 22,- |
| 100 mg | 0,05 | 328-37 | 21,- | 347-009-400 | 2,- | 317-009-600 | 13,- | 338-090-200 | 34,- | 962-457 | 22,- |
| 200 mg | 0,06 | 328-38 | 21,- | 347-009-400 | 2,- | 317-009-600 | 13,- | 338-090-200 | 34,- | 962-458 | 22,- |
| 500 mg | 0,08 | 328-39 | 21,- | 347-009-400 | 2,- | 317-009-600 | 13,- | 338-090-200 | 34,- | 962-459 | 22,- |
| 1 mg - 500 mg | - | 328-42 | 265,- | - | - | - | - | - | - | - | - |

Class F1 · Milligram weights, flat polygonal sheet

Test weight material: stainless steel

| Weight | Tol +/- mg | Milligram weight, flat polygonal sheet | | Plastic box | | Aluminium protected box | | Wooden box | | DAkkS certificate | |
|--------|------------|--|------|-------------|-----|-------------------------|------|-------------|------|-------------------|------|
| | | KERN | € | KERN | € | KERN | € | KERN | € | KERN | € |
| 1 mg | 0,02 | 328-01 | 13,- | 347-009-400 | 2,- | 317-009-600 | 13,- | 338-090-200 | 34,- | 962-451 | 22,- |
| 2 mg | 0,02 | 328-02 | 13,- | 347-009-400 | 2,- | 317-009-600 | 13,- | 338-090-200 | 34,- | 962-452 | 22,- |
| 5 mg | 0,02 | 328-03 | 13,- | 347-009-400 | 2,- | 317-009-600 | 13,- | 338-090-200 | 34,- | 962-453 | 22,- |
| 10 mg | 0,025 | 328-04 | 13,- | 347-009-400 | 2,- | 317-009-600 | 13,- | 338-090-200 | 34,- | 962-454 | 22,- |
| 20 mg | 0,03 | 328-05 | 13,- | 347-009-400 | 2,- | 317-009-600 | 13,- | 338-090-200 | 34,- | 962-455 | 22,- |
| 50 mg | 0,04 | 328-06 | 13,- | 347-009-400 | 2,- | 317-009-600 | 13,- | 338-090-200 | 34,- | 962-456 | 22,- |
| 100 mg | 0,05 | 328-07 | 13,- | 347-009-400 | 2,- | 317-009-600 | 13,- | 338-090-200 | 34,- | 962-457 | 22,- |
| 200 mg | 0,06 | 328-08 | 13,- | 347-009-400 | 2,- | 317-009-600 | 13,- | 338-090-200 | 34,- | 962-458 | 22,- |
| 500 mg | 0,08 | 328-09 | 13,- | 347-009-400 | 2,- | 317-009-600 | 13,- | 338-090-200 | 34,- | 962-459 | 22,- |

Class F1 · Individual weights, ECO shape or knob shape

Test weight material: stainless steel polished

| Weight | Tol +/- mg | Individual weight, ECO shape | | Individual weight, knob shape | | Plastic box | | Aluminium protected box | | Wooden box | | DAkkS certificate | |
|--------|------------|------------------------------|-------|-------------------------------|--------|-------------|------|-------------------------|-------|-------------|-------|-------------------|------|
| | | KERN | € | KERN | € | KERN | € | KERN | € | KERN | € | KERN | € |
| 1 g | 0,10 | 326-01 | 15,- | 327-01 | 33,- | 347-030-400 | 2,- | 317-010-600 | 13,- | 317-010-100 | 32,- | 962-431 | 22,- |
| 2 g | 0,12 | 326-02 | 15,- | 327-02 | 33,- | 347-030-400 | 2,- | 317-020-600 | 15,- | 317-020-100 | 30,- | 962-432 | 22,- |
| 5 g | 0,16 | 326-03 | 17,- | 327-03 | 34,- | 347-030-400 | 2,- | 317-030-600 | 14,- | 317-030-100 | 32,- | 962-433 | 22,- |
| 10 g | 0,20 | 326-04 | 21,- | 327-04 | 37,- | 347-050-400 | 2,- | 317-040-600 | 13,- | 317-040-100 | 30,- | 962-434 | 22,- |
| 20 g | 0,25 | 326-05 | 27,- | 327-05 | 42,- | 347-050-400 | 2,- | 317-050-600 | 13,- | 317-050-100 | 31,- | 962-435 | 22,- |
| 50 g | 0,30 | 326-06 | 36,- | 327-06 | 47,- | 347-070-400 | 2,- | 317-060-600 | 12,- | 317-060-100 | 35,- | 962-436 | 22,- |
| 100 g | 0,50 | 326-07 | 40,- | 327-07 | 54,- | 347-070-400 | 2,- | 317-070-600 | 13,- | 317-070-100 | 35,- | 962-437 | 24,- |
| 200 g | 1,00 | 326-08 | 49,- | 327-08 | 66,- | 347-080-400 | 2,10 | 317-080-600 | 13,- | 317-080-100 | 39,- | 962-438 | 24,- |
| 500 g | 2,50 | 326-09 | 98,- | 327-09 | 124,- | 347-090-400 | 3,- | 317-090-600 | 17,- | 317-090-100 | 46,- | 962-439 | 24,- |
| 1 kg | 5,00 | 326-11 | 130,- | 327-11 | 163,- | 347-110-400 | 3,80 | 317-110-600 | 25,- | 317-110-100 | 61,- | 962-441 | 24,- |
| 2 kg | 10 | 326-12 | 215,- | 327-12 | 245,- | 347-120-400 | 5,- | 317-120-600 | 29,- | 317-120-100 | 68,- | 962-442 | 31,- |
| 5 kg | 25 | 326-13 | 340,- | 327-13 | 395,- | 347-130-400 | 11,- | 317-130-600 | 53,- | 317-130-100 | 101,- | 962-443 | 31,- |
| 10 kg | 50 | 326-14 | 560,- | 327-14 | 680,- | 347-140-400 | 16,- | 317-140-600 | 75,- | 317-140-100 | 123,- | 962-444 | 31,- |
| 20 kg | 100 | - | - | 327-15 | 1830,- | - | - | 317-150-600 | 105,- | 317-150-100 | 580,- | 962-445 | 35,- |
| 50 kg | 250 | - | - | 327-16 | 3930,- | - | - | 317-160-600 | 305,- | 317-160-100 | 710,- | 962-446 | 47,- |

Class F1 · Block weights

Block weight material: stainless steel polished

| Weight | Tol +/- mg | Block weight | | Aluminium protected box | | DAkkS certificate | |
|--------|------------|--------------|--------|-------------------------|-------|-------------------|------|
| | | KERN | € | KERN | € | KERN | € |
| 5 kg | 25 | 326-36 | 950,- | 346-060-600 | 71,- | 962-443 | 31,- |
| 10 kg | 50 | 326-37 | 1380,- | 346-070-600 | 95,- | 962-444 | 31,- |
| 20 kg | 100 | 326-38 | 1830,- | 346-080-600 | 125,- | 962-445 | 35,- |
| 50 kg | 250 | 326-39 | 4370,- | 346-090-600 | 83,- | 962-446 | 47,- |

Class F1 · Test weights, stackable

Test weight material: stainless steel polished

| Weight | Tol +/- mg | Test weight | | Wooden box | | DAkkS certificate | |
|---|------------|-------------|---------------|-------------|--------------|-------------------|-------------|
| | | KERN | € | KERN | € | KERN | € |
|  5 kg | 25 | 327-131 | 1000,- | 337-131-100 | 465,- | 962-443 | 31,- |
| 10 kg | 50 | 327-141 | 1340,- | 337-141-100 | 300,- | 962-444 | 31,- |
| 20 kg | 100 | 327-151 | 1680,- | 337-151-100 | 325,- | 962-445 | 35,- |
| 50 kg | 250 | 327-161 | 3880,- | 337-161-100 | 510,- | 962-446 | 47,- |



Class F1 · Weight sets, ECO shape

Test weight material: Milligram weights stainless steel, Individual weights: polished stainless steel

| Weight sets | ECO shape in plastic case | | ECO shape in aluminium protected case | | ECO shape in wooden case | | DAkkS certificate | |
|---------------|---------------------------|---------------|---------------------------------------|---------------|--------------------------|---------------|-------------------|--------------|
| | KERN | € | KERN | € | KERN | € | KERN | € |
| 1 mg - 500 mg | 328-22 | 136,- | 328-226 | 220,- | - | - | 962-450 | 122,- |
| 1 mg - 50 g | 325-024 | 540,- | 325-026 | 390,- | 325-022 | 600,- | 962-401 | 205,- |
| 1 mg - 100 g | 325-034 | 600,- | 325-036 | 620,- | 325-032 | 650,- | 962-402 | 215,- |
| 1 mg - 200 g | 325-044 | 690,- | 325-046 | 710,- | 325-042 | 740,- | 962-403 | 240,- |
| 1 mg - 500 g | 325-054 | 790,- | 325-056 | 810,- | 325-052 | 910,- | 962-404 | 250,- |
| 1 mg - 1 kg | 325-064 | 1010,- | 325-066 | 1020,- | 325-062 | 1060,- | 962-405 | 265,- |
| 1 mg - 2 kg | 325-074 | 1300,- | 325-076 | 1320,- | 325-072 | 1370,- | 962-406 | 305,- |
| 1 mg - 5 kg | 325-084 | 1580,- | 325-086 | 1620,- | 325-082 | 1780,- | 962-407 | 320,- |
| 1 mg - 10 kg | - | - | 325-096 | 2340,- | 325-092 | 2390,- | 962-408 | 345,- |
| 1 g - 50 g | 326-024 | 370,- | 326-026 | 250,- | 326-022 | 435,- | 962-415 | 81,- |
| 1 g - 100 g | 326-034 | 420,- | 326-036 | 440,- | 326-032 | 490,- | 962-416 | 94,- |
| 1 g - 200 g | 326-044 | 520,- | 326-046 | 540,- | 326-042 | 600,- | 962-417 | 119,- |
| 1 g - 500 g | 326-054 | 610,- | 326-056 | 630,- | 326-052 | 750,- | 962-418 | 132,- |
| 1 g - 1 kg | 326-064 | 830,- | 326-066 | 850,- | 326-062 | 900,- | 962-419 | 145,- |
| 1 g - 2 kg | 326-074 | 1110,- | 326-076 | 1140,- | 326-072 | 1220,- | 962-420 | 182,- |
| 1 g - 5 kg | 326-084 | 1410,- | 326-086 | 1430,- | 326-082 | 1630,- | 962-421 | 200,- |
| 1 g - 10 kg | - | - | 326-096 | 2070,- | 326-092 | 2240,- | 962-422 | 220,- |

Class F1 · Weight sets, knob shape

Test weight material: Milligram weights stainless steel, Individual weights: polished stainless steel

| Weight sets | Knob shape in plastic case | | Knob shape in aluminium protected case | | Knob shape in wooden case | | DAkkS certificate | |
|---------------|----------------------------|---------------|--|---------------|---------------------------|---------------|-------------------|--------------|
| | KERN | € | KERN | € | KERN | € | KERN | € |
| 1 mg - 500 mg | 328-22 | 136,- | 328-226 | 220,- | - | - | 962-450 | 122,- |
| 1 mg - 50 g | 323-024 | 550,- | 323-026 | 465,- | 323-02 | 600,- | 962-401 | 205,- |
| 1 mg - 100 g | 323-034 | 610,- | 323-036 | 660,- | 323-03 | 650,- | 962-402 | 215,- |
| 1 mg - 200 g | 323-044 | 730,- | 323-046 | 800,- | 323-04 | 790,- | 962-403 | 240,- |
| 1 mg - 500 g | 323-054 | 860,- | 323-056 | 940,- | 323-05 | 980,- | 962-404 | 250,- |
| 1 mg - 1 kg | 323-064 | 1110,- | 323-066 | 1180,- | 323-06 | 1170,- | 962-405 | 265,- |
| 1 mg - 2 kg | 323-074 | 1580,- | 323-076 | 1590,- | 323-07 | 1730,- | 962-406 | 305,- |
| 1 mg - 5 kg | 323-084 | 1960,- | 323-086 | 1960,- | 323-08 | 2160,- | 962-407 | 320,- |
| 1 mg - 10 kg | - | - | 323-096 | 2790,- | 323-09 | 2900,- | 962-408 | 345,- |
| 1 g - 50 g | 324-024 | 385,- | 324-026 | 330,- | 324-02 | 445,- | 962-415 | 81,- |
| 1 g - 100 g | 324-034 | 435,- | 324-036 | 485,- | 324-03 | 500,- | 962-416 | 94,- |
| 1 g - 200 g | 324-044 | 650,- | 324-046 | 640,- | 324-04 | 720,- | 962-417 | 119,- |
| 1 g - 500 g | 324-054 | 770,- | 324-056 | 770,- | 324-05 | 880,- | 962-418 | 132,- |
| 1 g - 1 kg | 324-064 | 1020,- | 324-066 | 1020,- | 324-06 | 1070,- | 962-419 | 145,- |
| 1 g - 2 kg | 324-074 | 1460,- | 324-076 | 1420,- | 324-07 | 1570,- | 962-420 | 182,- |
| 1 g - 5 kg | 324-084 | 1840,- | 324-086 | 1840,- | 324-08 | 2040,- | 962-421 | 200,- |
| 1 g - 10 kg | - | - | 324-096 | 2650,- | 324-09 | 2830,- | 962-422 | 220,- |

 New model

TEST WEIGHTS AND BOXES CLASS F2



Milligram weights,
flat polygonal sheet



Individual weights/Weight sets,
knob shape



Block weight, stainless steel



Test weights (10 - 50 kg),
finely turned stainless steel,
KERN 337-141 ff,
optional: Wooden box



Plastic box,
lined, for
individual
weights
≤ 200 g



Plastic box,
lined, for
individual
weights
≥ 500 g



Aluminium protected box, lined,
for individual weights



Wooden box, not lined
for individual weights ≤ 500 g



Wooden box, not lined,
for individual weights ≥ 1 kg



Milligram weight
set in plastic case
(338-22)



Milligram weight
set in aluminium
protected case,
lined (338-226)



Plastic case, lined, for weight sets,
knob shape





Aluminium protected case, lined,
for weight sets, knob shape



Wooden case, for weight sets,
knob shape



Class F2 · Milligram weights, flat polygonal sheet

Test weight material: stainless steel

| Weight | Tol +/- mg | Milligram weight, flat polygonal sheet | | Plastic box | | Aluminium protected box | | Wooden box | | DAkkS certificate | |
|--------|------------|--|------|-------------|---|-------------------------|------|---|------|-------------------|---|
| | | KERN | € | KERN |  | € | KERN |  | € | KERN |  |
| 1 mg | 0,06 | 338-01 | 8,60 | 347-009-400 | 2,- | 317-009-600 | 13,- | 338-090-200 | 34,- | 962-451 | 22,- |
| 2 mg | 0,06 | 338-02 | 8,30 | 347-009-400 | 2,- | 317-009-600 | 13,- | 338-090-200 | 34,- | 962-452 | 22,- |
| 5 mg | 0,06 | 338-03 | 8,60 | 347-009-400 | 2,- | 317-009-600 | 13,- | 338-090-200 | 34,- | 962-453 | 22,- |
| 10 mg | 0,08 | 338-04 | 8,60 | 347-009-400 | 2,- | 317-009-600 | 13,- | 338-090-200 | 34,- | 962-454 | 22,- |
| 20 mg | 0,10 | 338-05 | 8,30 | 347-009-400 | 2,- | 317-009-600 | 13,- | 338-090-200 | 34,- | 962-455 | 22,- |
| 50 mg | 0,12 | 338-06 | 8,60 | 347-009-400 | 2,- | 317-009-600 | 13,- | 338-090-200 | 34,- | 962-456 | 22,- |
| 100 mg | 0,16 | 338-07 | 8,60 | 347-009-400 | 2,- | 317-009-600 | 13,- | 338-090-200 | 34,- | 962-457 | 22,- |
| 200 mg | 0,20 | 338-08 | 8,30 | 347-009-400 | 2,- | 317-009-600 | 13,- | 338-090-200 | 34,- | 962-458 | 22,- |
| 500 mg | 0,25 | 338-09 | 8,60 | 347-009-400 | 2,- | 317-009-600 | 13,- | 338-090-200 | 34,- | 962-459 | 22,- |

Class F2 · Individual weights, knob shape

Test weight material: finely turned stainless steel

| Weight | Tol +/- mg | Individual weight, knob shape | | Plastic box | | Aluminium protected box | | Wooden box | | DAkkS certificate | |
|--------|------------|-------------------------------|--------|-------------|---|-------------------------|-------|---|-------|-------------------|---|
| | | KERN | € | KERN |  | € | KERN |  | € | KERN |  |
| 1 g | 0,3 | 337-01 | 17,- | 347-030-400 | 2,- | 317-010-600 | 13,- | 337-010-200 | 21,- | 962-431 | 22,- |
| 2 g | 0,4 | 337-02 | 17,- | 347-030-400 | 2,- | 317-020-600 | 15,- | 337-020-200 | 17,- | 962-432 | 22,- |
| 5 g | 0,5 | 337-03 | 18,- | 347-030-400 | 2,- | 317-030-600 | 14,- | 337-030-200 | 18,- | 962-433 | 22,- |
| 10 g | 0,6 | 337-04 | 20,- | 347-050-400 | 2,- | 317-040-600 | 13,- | 337-040-200 | 18,- | 962-434 | 22,- |
| 20 g | 0,8 | 337-05 | 28,- | 347-050-400 | 2,- | 317-050-600 | 13,- | 337-050-200 | 18,- | 962-435 | 22,- |
| 50 g | 1,0 | 337-06 | 30,- | 347-070-400 | 2,- | 317-060-600 | 12,- | 337-060-200 | 20,- | 962-436 | 22,- |
| 100 g | 1,6 | 337-07 | 34,- | 347-070-400 | 2,- | 317-070-600 | 13,- | 337-070-200 | 22,- | 962-437 | 24,- |
| 200 g | 3,0 | 337-08 | 41,- | 347-080-400 | 2,10 | 317-080-600 | 13,- | 337-080-200 | 24,- | 962-438 | 24,- |
| 500 g | 8,0 | 337-09 | 58,- | 347-090-400 | 3,- | 317-090-600 | 17,- | 337-090-200 | 28,- | 962-439 | 24,- |
| 1 kg | 16 | 337-11 | 81,- | 347-110-400 | 3,80 | 317-110-600 | 25,- | 337-110-200 | 43,- | 962-441 | 24,- |
| 2 kg | 30 | 337-12 | 124,- | 347-120-400 | 5,- | 317-120-600 | 29,- | 337-120-200 | 41,- | 962-442 | 31,- |
| 5 kg | 80 | 337-13 | 220,- | 347-130-400 | 11,- | 317-130-600 | 53,- | 337-130-200 | 85,- | 962-443 | 31,- |
| 10 kg | 160 | 337-14 | 385,- | 347-140-400 | 16,- | 317-140-600 | 75,- | 337-140-200 | 93,- | 962-444 | 31,- |
| 20 kg | 300 | 337-15 | 750,- | - | - | 317-150-600 | 105,- | 337-150-200 | 385,- | 962-445 | 35,- |
| 50 kg | 800 | 337-16 | 1430,- | - | - | 317-160-600 | 305,- | 337-160-200 | 590,- | 962-446 | 47,- |

Class F2 · Test weights, stackable

Test weight material: finely turned stainless steel

| Weight | Tol +/- mg | Test weight | Wooden box | | DAkkS certificate | | |
|--|------------|-------------|------------|-------------|-------------------|---------|------|
| | | | € | KERN | € | KERN | |
|  5 kg | 80 | 337-131 | 550,- | 337-131-200 | 360,- | 962-443 | 31,- |
| 10 kg | 160 | 337-141 | 640,- | 337-141-200 | 360,- | 962-444 | 31,- |
| 20 kg | 300 | 337-151 | 820,- | 337-151-200 | 385,- | 962-445 | 35,- |
| 50 kg | 800 | 337-161 | 2080,- | 337-161-200 | 590,- | 962-446 | 47,- |

Class F2 · Block weights



Block weight material: stainless steel glass bead blasted

| Weight | Tol +/- mg | Block weight | Aluminium protected box | | DAkkS certificate | | |
|--------|------------|--------------|-------------------------|-------------|-------------------|---------|------|
| | | | € | KERN | € | KERN | |
| 5 kg | 80 | 336-36 | 520,- | 346-060-600 | 71,- | 962-443 | 31,- |
| 10 kg | 160 | 336-37 | 720,- | 346-070-600 | 95,- | 962-444 | 31,- |
| 20 kg | 300 | 336-38 | 920,- | 346-080-600 | 125,- | 962-445 | 35,- |
| 50 kg | 800 | 336-39 | 2250,- | 346-090-600 | 83,- | 962-446 | 47,- |

 New model

Class F2 · Weight sets, knob shape

Test weight material: Milligram weights stainless steel, individual weights finely turned stainless steel

| Weight | Knob shape in plastic case | | Knob shape in aluminium protected case | | Knob shape in wooden case | | DAkkS certificate | | | | |
|---------------|----------------------------|---|--|---------|---|---------------|-------------------|---|---------------|---------|--------------|
| | KERN |  | € | KERN |  | € | KERN |  | € | | |
| 1 mg - 500 mg | 328-22 | | 136,- | 328-226 | | 220,- | - | | - | 962-450 | 122,- |
| 1 mg - 50 g | 333-024 | | 365,- | 333-026 | | 410,- | 333-02 | | 370,- | | 205,- |
| 1 mg - 100 g | 333-034 | | 400,- | 333-036 | | 450,- | 333-03 | | 405,- | 962-402 | 215,- |
| 1 mg - 200 g | 333-044 | | 480,- | 333-046 | | 520,- | 333-04 | | 490,- | 962-403 | 240,- |
| 1 mg - 500 g | 333-054 | | 540,- | 333-056 | | 600,- | 333-05 | | 560,- | 962-404 | 250,- |
| 1 mg - 1 kg | 333-064 | | 710,- | 333-066 | | 750,- | 333-06 | | 710,- | 962-405 | 265,- |
| 1 mg - 2 kg | 333-074 | | 950,- | 333-076 | | 1050,- | 333-07 | | 980,- | 962-406 | 305,- |
| 1 mg - 5 kg | 333-084 | | 1170,- | 333-086 | | 1330,- | 333-08 | | 1390,- | 962-407 | 320,- |
| 1 mg - 10 kg | - | | - | 333-096 | | 1980,- | 333-09 | | 1720,- | 962-408 | 345,- |
| 1 g - 50 g | 334-024 | | 255,- | 334-026 | | 275,- | 334-02 | | 255,- | 962-415 | 81,- |
| 1 g - 100 g | 334-034 | | 290,- | 334-036 | | 315,- | 334-03 | | 295,- | 962-416 | 94,- |
| 1 g - 200 g | 334-044 | | 370,- | 334-046 | | 415,- | 334-04 | | 380,- | 962-417 | 119,- |
| 1 g - 500 g | 334-054 | | 430,- | 334-056 | | 490,- | 334-05 | | 450,- | 962-418 | 132,- |
| 1 g - 1 kg | 334-064 | | 600,- | 334-066 | | 620,- | 334-06 | | 580,- | 962-419 | 145,- |
| 1 g - 2 kg | 334-074 | | 840,- | 334-076 | | 940,- | 334-07 | | 850,- | 962-420 | 182,- |
| 1 g - 5 kg | 334-084 | | 1050,- | 334-086 | | 1230,- | 334-08 | | 1260,- | 962-421 | 200,- |
| 1 g - 10 kg | - | | - | 334-096 | | 1750,- | 334-09 | | 1590,- | 962-422 | 220,- |

TEST WEIGHTS AND BOXES CLASS M1



Milligram weights,
flat polygonal sheet



Individual weights/weight sets,
knob shape, finely turned
stainless steel



Hook weights, finely turned
stainless steel



Slotted weights, finely turned
stainless steel



Plastic box, for individual
weights ≤ 200 g, for hook
weights and slotted weights
≤ 50 g



Plastic box, lined, for
individual weights ≥ 500 g,
for hook weights and
slotted weights ≥ 100 g



Aluminium protected box,
lined, for individual weights



Wooden box, not lined,
for individual weights
≤ 500 g



Wooden box, not lined,
for individual weights ≥ 1 kg



Milligram weight
set in plastic case
(348-22)

Milligram weight
set in aluminium
protected case,
lined (348-226)



Plastic case, lined, for weight sets,
knob shape, finely turned
stainless steel



Aluminium protected case, lined,
for weight sets, knob shape,
finely turned stainless steel



Wooden case, for weight sets,
knob shape, finely turned
stainless steel



Test weights (10 - 50 kg), finely turned
stainless steel KERN 347-141 ff,
optional: Wooden box



Beam bars, aluminium or
stainless steel



Block weights, lacquered cast iron/stainless steel glass bead blasted,
optional: Aluminium protected box, lined



Class M1 · Milligram weights, flat polygonal sheet

Test weight material: stainless steel

| Weight | Tol +/- mg | Milligram weight, flat polygonal sheet | | Plastic box | | Aluminium protected box | | Wooden box | | DAkkS certificate | |
|--------|------------|--|------|-------------|-----|-------------------------|------|-------------|------|-------------------|------|
| | | KERN | € | KERN | € | KERN | € | KERN | € | KERN | € |
| 1 mg | 0,20 | 348-01 | 5,10 | 347-009-400 | 2,- | 317-009-600 | 13,- | 338-090-200 | 34,- | 962-651 | 18,- |
| 2 mg | 0,20 | 348-02 | 5,10 | 347-009-400 | 2,- | 317-009-600 | 13,- | 338-090-200 | 34,- | 962-652 | 18,- |
| 5 mg | 0,20 | 348-03 | 5,10 | 347-009-400 | 2,- | 317-009-600 | 13,- | 338-090-200 | 34,- | 962-653 | 18,- |
| 10 mg | 0,25 | 348-04 | 5,- | 347-009-400 | 2,- | 317-009-600 | 13,- | 338-090-200 | 34,- | 962-654 | 18,- |
| 20 mg | 0,30 | 348-05 | 5,10 | 347-009-400 | 2,- | 317-009-600 | 13,- | 338-090-200 | 34,- | 962-655 | 18,- |
| 50 mg | 0,40 | 348-06 | 5,10 | 347-009-400 | 2,- | 317-009-600 | 13,- | 338-090-200 | 34,- | 962-656 | 18,- |
| 100 mg | 0,50 | 348-07 | 5,10 | 347-009-400 | 2,- | 317-009-600 | 13,- | 338-090-200 | 34,- | 962-657 | 18,- |
| 200 mg | 0,60 | 348-08 | 5,10 | 347-009-400 | 2,- | 317-009-600 | 13,- | 338-090-200 | 34,- | 962-658 | 18,- |
| 500 mg | 0,80 | 348-09 | 5,10 | 347-009-400 | 2,- | 317-009-600 | 13,- | 338-090-200 | 34,- | 962-659 | 18,- |

Class M1 · Individual weights, knob shape

Test weights material: stainless steel

| Weight | Tol +/- mg | Individual weight | | Plastic box | | Aluminium protected box | | Wooden box | | DAkkS certificate | |
|--------|------------|-------------------|-------|-------------|------|-------------------------|------|-------------|------|-------------------|------|
| | | KERN | € | KERN | € | KERN | € | KERN | € | KERN | € |
| 1 g | 1,0 | 347-01 | 8,70 | 347-030-400 | 2,- | 317-010-600 | 13,- | 337-010-200 | 21,- | 962-631 | 18,- |
| 2 g | 1,2 | 347-02 | 8,70 | 347-030-400 | 2,- | 317-020-600 | 15,- | 337-020-200 | 17,- | 962-632 | 18,- |
| 5 g | 1,6 | 347-03 | 8,90 | 347-030-400 | 2,- | 317-030-600 | 14,- | 337-030-200 | 18,- | 962-633 | 18,- |
| 10 g | 2,0 | 347-04 | 9,30 | 347-050-400 | 2,- | 317-040-600 | 13,- | 337-040-200 | 18,- | 962-634 | 18,- |
| 20 g | 2,5 | 347-05 | 16,- | 347-050-400 | 2,- | 317-050-600 | 13,- | 337-050-200 | 18,- | 962-635 | 18,- |
| 50 g | 3,0 | 347-06 | 17,- | 347-070-400 | 2,- | 317-060-600 | 12,- | 337-060-200 | 20,- | 962-636 | 18,- |
| 100 g | 5,0 | 347-07 | 21,- | 347-070-400 | 2,- | 317-070-600 | 13,- | 337-070-200 | 22,- | 962-637 | 20,- |
| 200 g | 10 | 347-08 | 26,- | 347-080-400 | 2,10 | 317-080-600 | 13,- | 337-080-200 | 24,- | 962-638 | 20,- |
| 500 g | 25 | 347-09 | 37,- | 347-090-400 | 3,- | 317-090-600 | 17,- | 337-090-200 | 28,- | 962-639 | 20,- |
| 1 kg | 50 | 347-11 | 59,- | 347-110-400 | 3,80 | 317-110-600 | 25,- | 337-110-200 | 43,- | 962-641 | 20,- |
| 2 kg | 100 | 347-12 | 98,- | 347-120-400 | 5,- | 317-120-600 | 29,- | 337-120-200 | 41,- | 962-642 | 21,- |
| 5 kg | 250 | 347-13 | 210,- | 347-130-400 | 11,- | 317-130-600 | 53,- | 337-130-200 | 85,- | 962-643 | 21,- |
| 10 kg | 500 | 347-14 | 375,- | 347-140-400 | 16,- | 317-140-600 | 75,- | 337-140-200 | 93,- | 962-644 | 21,- |

Class M1 · Block weights

Block weight material: lacquered cast iron, surface and edges machined or unmachined (ECO)

| Weight | Tol +/- g | Block weight | | ECO Block weight | | Aluminium protected box | | DAkkS certificate | |
|--------|-----------|--------------|-------|------------------|-------|-------------------------|-------|-------------------|------|
| | | KERN | € | KERN | € | KERN | € | KERN | € |
| 5 kg | 0,25 | 346-86 | 69,- | 346-76 | 61,- | 346-060-600 | 71,- | 962-643 | 21,- |
| 10 kg | 0,50 | 346-87 | 109,- | 346-77 | 97,- | 346-070-600 | 95,- | 962-644 | 21,- |
| 20 kg | 1,00 | 346-88 | 175,- | 346-78 | 177,- | 346-080-600 | 125,- | 962-645 | 26,- |
| 50 kg | 2,50 | 346-89 | 410,- | 346-79 | 440,- | 346-090-600 | 83,- | 962-646 | 29,- |

Class M1 · Block weights

Block weight material: stainless steel glass bead blasted

| Weight | Tol +/- g | Block weight | | Aluminium protected box | | DAkkS certificate | |
|--------|-----------|--------------|--------|-------------------------|-------|-------------------|------|
| | | KERN | € | KERN | € | KERN | € |
| 5 kg | 0,25 | 346-06 | 445,- | 346-060-600 | 71,- | 962-643 | 21,- |
| 10 kg | 0,50 | 346-07 | 580,- | 346-070-600 | 95,- | 962-644 | 21,- |
| 20 kg | 1,00 | 346-08 | 810,- | 346-080-600 | 125,- | 962-645 | 26,- |
| 50 kg | 2,50 | 346-09 | 2050,- | 346-090-600 | 83,- | 962-646 | 29,- |

Class M1 · Test weights, stackable

Test weight material: finely turned stainless steel

| Weight | Tol +/- g | Test weight | | Wooden box | | DAkkS certificate | | |
|---|-----------|-------------|--------|-------------|-------|-------------------|------|---|
| | | KERN | € | KERN | € | KERN | € | € |
|  5 kg | 0,25 | 347-131 | 540,- | 337-131-200 | 360,- | 962-643 | 21,- | |
| 10 kg | 0,5 | 347-141 | 620,- | 337-141-200 | 360,- | 962-644 | 21,- | |
| 20 kg | 1,0 | 347-151 | 790,- | 337-151-200 | 385,- | 962-645 | 26,- | |
| 50 kg | 2,5 | 347-161 | 2040,- | 337-161-200 | 590,- | 962-646 | 29,- | |

Class M1 · Heavy duty weights, stackable

Heavy duty weight material: lacquered steel

Designed to be lifted with forklift trucks or cranes, delivery time is approx. 6-8 weeks

Dimensions: see internet on www.kern-sohn.com

| Weight | Tol +/- g | Heavy duty weight | | DAkkS certificate | |
|---------|-----------|-------------------|---------|-------------------|-------|
| | | KERN | € | KERN | € |
| 100 kg | 5 | 346-81 | 1920,- | 962-691 | 76,- |
| 200 kg | 10 | 346-82 | 2930,- | 962-692 | 76,- |
| 500 kg | 25 | 346-83 | 5310,- | 962-693 | 76,- |
| 1000 kg | 50 | 346-84 | 7550,- | 962-694 | 166,- |
| 2000 kg | 100 | 346-85 | 14000,- | 962-695 | 305,- |

Class M1 · Weight sets, knob shape

Test weight material: Milligram weights stainless steel, individual weights finely turned stainless steel

| Weight | Knob shape, in plastic case | | Knob shape, in aluminium protected case | | Knob shape, in wooden case | | DAkkS certificate | | |
|---------------|-----------------------------|-------|---|--------|----------------------------|--------|-------------------|---------|------|
| | KERN | € | KERN | € | KERN | € | KERN | € | € |
| 1 mg - 500 mg | 348-22 | 64,- | 348-226 | 122,- | - | - | - | 962-650 | 76,- |
| 1 mg - 50 g | 343-024 | 250,- | 343-026 | 245,- | 343-02 | 230,- | 962-601 | 129,- | |
| 1 mg - 100 g | 343-034 | 270,- | 343-036 | 265,- | 343-03 | 255,- | 962-602 | 135,- | |
| 1 mg - 200 g | 343-044 | 320,- | 343-046 | 315,- | 343-04 | 315,- | 962-603 | 152,- | |
| 1 mg - 500 g | 343-054 | 360,- | 343-056 | 350,- | 343-05 | 365,- | 962-604 | 159,- | |
| 1 mg - 1 kg | 343-064 | 530,- | 343-066 | 450,- | 343-06 | 540,- | 962-605 | 167,- | |
| 1 mg - 2 kg | 343-074 | 700,- | 343-076 | 680,- | 343-07 | 730,- | 962-606 | 183,- | |
| 1 mg - 5 kg | 343-084 | 890,- | 343-086 | 920,- | 343-08 | 1040,- | 962-607 | 195,- | |
| 1 mg - 10 kg | - | - | 343-096 | 1350,- | 343-09 | 1400,- | 962-608 | 205,- | |
| 1 g - 50 g | 344-024 | 174,- | 344-026 | 172,- | 344-02 | 153,- | 962-615 | 50,- | |
| 1 g - 100 g | 344-034 | 194,- | 344-036 | 193,- | 344-03 | 184,- | 962-616 | 60,- | |
| 1 g - 200 g | 344-044 | 245,- | 344-046 | 245,- | 344-04 | 240,- | 962-617 | 73,- | |
| 1 g - 500 g | 344-054 | 285,- | 344-056 | 285,- | 344-05 | 300,- | 962-618 | 82,- | |
| 1 g - 1 kg | 344-064 | 455,- | 344-066 | 380,- | 344-06 | 445,- | 962-619 | 90,- | |
| 1 g - 2 kg | 344-074 | 630,- | 344-076 | 610,- | 344-07 | 630,- | 962-620 | 108,- | |
| 1 g - 5 kg | 344-084 | 820,- | 344-086 | 860,- | 344-08 | 930,- | 962-621 | 116,- | |
| 1 g - 10 kg | - | - | 344-096 | 1300,- | 344-09 | 1310,- | 962-622 | 126,- | |

Tip:

We also offer a large range of heavy-duty weights in other materials, (e.g. stainless steel) and in other forms (e.g. discs) or individual weight containers, please ask for details.

 New model

Class M1 · Slotted weights

Slotted weight material: finely turned stainless steel

| Weight | Tol +/- mg | Slotted weight | Plastic box, lined | | DAkkS certificate | | |
|--------|------------|----------------|--------------------|-------------|-------------------|---------|------|
| | | | € | KERN | € | KERN | |
| | | KERN | | | | | |
| 1 g | 1,0 | 347-015 | 28,- | 347-030-400 | 2,- | 962-631 | 18,- |
| 2 g | 1,2 | 347-025 | 28,- | 347-030-400 | 2,- | 962-632 | 18,- |
| 5 g | 1,6 | 347-035 | 30,- | 347-030-400 | 2,- | 962-633 | 18,- |
| 10 g | 2,0 | 347-045 | 33,- | 347-030-400 | 2,- | 962-634 | 18,- |
| 20 g | 2,5 | 347-055 | 35,- | 347-080-400 | 2,10 | 962-635 | 18,- |
| 50 g | 3,0 | 347-065 | 37,- | 347-080-400 | 2,10 | 962-636 | 18,- |
| 100 g | 5,0 | 347-075 | 43,- | 347-090-400 | 3,- | 962-637 | 20,- |
| 200 g | 10 | 347-085 | 53,- | 347-090-400 | 3,- | 962-638 | 20,- |
| 500 g | 25 | 347-095 | 72,- | 347-110-400 | 3,80 | 962-639 | 20,- |
| 1 kg | 50 | 347-115 | 129,- | 347-130-400 | 11,- | 962-641 | 20,- |
| 2 kg | 100 | 347-125 | 159,- | 347-130-400 | 11,- | 962-642 | 21,- |
| 5 kg | 250 | 347-135 | 285,- | 347-140-400 | 16,- | 962-643 | 21,- |
| 10 kg | 500 | 347-145 | 425,- | 347-140-400 | 16,- | 962-644 | 21,- |



Class M1 · Beam bars, for fixing slotted weights

Beam bars material: 10 g: aluminium, 100 g-1 kg: finely turned stainless steel

| Own weight beam bar | Maximum total load ⁽¹⁾ | Largest slotted weight possible | Material | Length | Beam bar | DAkkS certificate | | |
|---------------------|-----------------------------------|---------------------------------|-----------------|--------|----------------|-------------------|---------|------|
| | | | | | | € | KERN | |
| | | | | | KERN | € | KERN | € |
| 10 g | 200 g | 100 g | Aluminium | 117,5 | 347-445-100* | 56,- | 962-634 | 18,- |
| 100 g | 2 kg | 1 kg | Stainless steel | 238 | 347-075-100** | 77,- | 962-637 | 20,- |
| 500 g | 20 kg | 10 kg | Stainless steel | 639 | 347-095-100*** | 127,- | 962-639 | 20,- |
| 1 kg | 40 kg | 10 kg | Stainless steel | 1020 | 347-115-100*** | 160,- | 962-641 | 20,- |

⁽¹⁾ is exclusive of the own weight of the beam bar, e.g. the maximum possible total weight is calculated from "Maximum total load" + "own weight beam bar"

Class M1 · Slotted weights

Slotted weight material: finely turned stainless steel (only compatible with the 347-...7-100 series supporting bars)

| Weight | Tol +/- mg | Slotted weight | DAkkS certificate | | |
|--------|------------|----------------|-------------------|---------|------|
| | | | € | KERN | |
| | | KERN | € | KERN | € |
| 5 g | 1,6 | 347-037 | 30,- | 962-633 | 18,- |
| 10 g | 2,0 | 347-047 | 31,- | 962-634 | 18,- |
| 20 g | 2,5 | 347-057 | 34,- | 962-635 | 18,- |
| 50 g | 3,0 | 347-067 | 39,- | 962-636 | 18,- |
| 100 g | 5,0 | 347-077 | 67,- | 962-637 | 20,- |
| 200 g | 10 | 347-087 | 75,- | 962-638 | 20,- |
| 500 g | 25 | 347-097 | 85,- | 962-639 | 20,- |
| 1 kg | 50 | 347-117 | 182,- | 962-641 | 20,- |
| 2 kg | 100 | 347-127 | 215,- | 962-642 | 21,- |
| 5 kg | 250 | 347-137 | 410,- | 962-643 | 21,- |
| 10 kg | 500 | 347-147 | 520,- | 962-644 | 21,- |



Class M1 · Beam bars, for fixing slotted weights

Beam bars material: 10 g: aluminium, 100 g-1 kg: finely turned stainless steel (only compatible with the 347-...7 series slotted weights)

| Own weight beam bar | Maximum total load ⁽¹⁾ | Largest slotted weight possible | Material | Length | Tol +/- mg | Beam bar | DAkkS certificate | | |
|---------------------|-----------------------------------|---------------------------------|-----------------|--------|------------|-------------|-------------------|---------|------|
| | | | | | | | € | KERN | |
| | | | | | | KERN | € | KERN | € |
| 1 kg | 125 kg | 10 kg | Stainless steel | 300 mm | 50 | 347-117-100 | 185,- | 962-641 | 20,- |
| 5 kg | 161 kg | 10 kg | Stainless steel | 600 mm | 250 | 347-137-100 | 430,- | 962-643 | 21,- |
| 10 kg | 180 kg | 10 kg | Stainless steel | 800 mm | 500 | 347-147-100 | 560,- | 962-644 | 21,- |

⁽¹⁾ is exclusive of the own weight of the beam bar, e.g. the maximum possible total weight is calculated from "Maximum total load" + "own weight beam bar"

Class M1 · Hook weights

Hook weight material: finely turned stainless steel

| Weight | Tol +/- mg | Hook weight | Plastic box, lined | | DAkkS certificate | | |
|--------|------------|-------------|--------------------|-------------|-------------------|---------|-------------|
| | | KERN | € | KERN | € | KERN | € |
| 1 g | 1,0 | 347-016 | 26,- | 347-030-400 | 2,- | 962-631 | 18,- |
| 2 g | 1,2 | 347-026 | 26,- | 347-030-400 | 2,- | 962-632 | 18,- |
| 5 g | 1,6 | 347-036 | 27,- | 347-030-400 | 2,- | 962-633 | 18,- |
| 10 g | 2,0 | 347-046 | 27,- | 347-050-400 | 2,- | 962-634 | 18,- |
| 20 g | 2,5 | 347-056 | 28,- | 347-050-400 | 2,- | 962-635 | 18,- |
| 50 g | 3,0 | 347-066 | 33,- | 347-070-400 | 2,- | 962-636 | 18,- |
| 100 g | 5,0 | 347-076 | 37,- | 347-090-400 | 3,- | 962-637 | 20,- |
| 200 g | 10,0 | 347-086 | 46,- | 347-090-400 | 3,- | 962-638 | 20,- |
| 500 g | 25,0 | 347-096 | 79,- | 347-110-400 | 3,80 | 962-639 | 20,- |
| 1 kg | 50,0 | 347-116 | 98,- | 347-120-400 | 5,- | 962-641 | 20,- |
| 2 kg | 100,0 | 347-126 | 140,- | 347-130-400 | 11,- | 962-642 | 21,- |
| 5 kg | 250,0 | 347-136 | 250,- | 347-140-400 | 16,- | 962-643 | 21,- |
| 10 kg | 500,0 | 347-146 | 425,- | - | - | 962-644 | 21,- |



Newton weights (N):

All hook and slotted weights as well as beam bars are available **with N adjustment according to M1 tolerances**, additional price € 8,-/pc. We need to know the exact location of use of the newton weights (street, postcode, city and country).

DAkkS calibration certificate for N weights: identical to DAkkS prices for individual weights **M1**, additional price € 8,-

TEST WEIGHTS AND BOXES CLASSES M2 · M3



Individual weights/Weight sets,
knob shape, stainless steel



Individual weights/Weight sets,
knob shape, lacquered cast iron



Block weights,
lacquered cast iron



Plastic box, lined,
for individual weights



Aluminium protected box,
lined, for individual weights



Wooden box, not lined, for
individual weights ≤ 500 g,
❗ not appropriate for
cast iron weights



Wooden box, not lined, for
individual weights ≥ 1 kg,
❗ not appropriate for
cast iron weights



Aluminium protected case,
lined, for block weights



Aluminium protected case, lined, for weight
sets knob shape, finely turned stainless steel,
❗ not appropriate for cast iron weights





Wooden case, for weight sets, knob shape,
finely turned stainless steel



Wooden block, for weight sets,
knob shape, lacquered cast iron

Class M2 · Individual weights, knob shape

Test weight material: finely turned stainless steel

| Weight | Tol +/- mg | Individual weight, knob shape | Plastic box | | Aluminium protected box | | Wooden box | | DAkkS certificate | | |
|--------|------------|-------------------------------|-------------|--|-------------------------|---|------------|--|-------------------|---------|------|
| | | | € | KERN  | € | KERN  | € | KERN  | € | KERN | € |
| 1 g | 3 | 357-01 | 8,70 | 347-030-400 | 2,- | 317-010-600 | 13,- | 337-010-200 | 21,- | 962-631 | 18,- |
| 2 g | 4 | 357-02 | 8,70 | 347-030-400 | 2,- | 317-020-600 | 15,- | 337-020-200 | 17,- | 962-632 | 18,- |
| 5 g | 5 | 357-03 | 8,90 | 347-030-400 | 2,- | 317-030-600 | 14,- | 337-030-200 | 18,- | 962-633 | 18,- |
| 10 g | 6 | 357-04 | 9,30 | 347-050-400 | 2,- | 317-040-600 | 13,- | 337-040-200 | 18,- | 962-634 | 18,- |
| 20 g | 8 | 357-05 | 16,- | 347-050-400 | 2,- | 317-050-600 | 13,- | 337-050-200 | 18,- | 962-635 | 18,- |
| 50 g | 10 | 357-06 | 17,- | 347-070-400 | 2,- | 317-060-600 | 12,- | 337-060-200 | 20,- | 962-636 | 18,- |
| 100 g | 16 | 357-07 | 21,- | 347-070-400 | 2,- | 317-070-600 | 13,- | 337-070-200 | 22,- | 962-637 | 20,- |
| 200 g | 30 | 357-08 | 26,- | 347-080-400 | 2,10 | 317-080-600 | 13,- | 337-080-200 | 24,- | 962-638 | 20,- |
| 500 g | 80 | 357-09 | 36,- | 347-090-400 | 3,- | 317-090-600 | 17,- | 337-090-200 | 28,- | 962-639 | 20,- |
| 1 kg | 160 | 357-11 | 59,- | 347-110-400 | 3,80 | 317-110-600 | 25,- | 337-110-200 | 43,- | 962-641 | 20,- |
| 2 kg | 300 | 357-12 | 94,- | 347-120-400 | 5,- | 317-120-600 | 29,- | 337-120-200 | 41,- | 962-642 | 21,- |
| 5 kg | 800 | 357-13 | 198,- | 347-130-400 | 11,- | 317-130-600 | 53,- | 337-130-200 | 85,- | 962-643 | 21,- |
| 10 kg | 1600 | 357-14 | 330,- | 347-140-400 | 16,- | 317-140-600 | 75,- | 337-140-200 | 93,- | 962-644 | 21,- |



Class M2 · Block weights

Block weight material: lacquered cast iron, surface and edges machined or unmachined (ECO)

| Weight | Tol +/- g | Block weight | ECO block weight | | Aluminium protected box | | DAkkS certificate | | |
|--------|-----------|--------------|------------------|--------|-------------------------|---|-------------------|---------|------|
| | | | € | KERN | € | KERN  | € | KERN | € |
| 5 kg | 0,8 | 356-86 | 69,- | 356-76 | 61,- | 346-060-600 | 71,- | 962-643 | 21,- |
| 10 kg | 1,6 | 356-87 | 116,- | 356-77 | 97,- | 346-070-600 | 95,- | 962-644 | 21,- |
| 20 kg | 3,0 | 356-88 | 196,- | 356-78 | 177,- | 346-080-600 | 125,- | 962-645 | 26,- |
| 50 kg | 8,0 | 356-89 | 480,- | 356-79 | 430,- | 346-090-600 | 83,- | 962-646 | 29,- |

Class M2 · Weight sets, knob shape

Test weight material: finely turned stainless steel

| Weight | Knob shape, in aluminium protected case | | Knob shape, in wooden case | | DAkkS certificate | |
|-------------|---|--|----------------------------|--|-------------------|---------|
| | € | KERN  | € | KERN  | € | KERN |
| 1 g - 50 g | 172,- | 354-026 | 153,- | 354-02 | 50,- | 962-615 |
| 1 g - 100 g | 193,- | 354-036 | 184,- | 354-03 | 60,- | 962-616 |
| 1 g - 200 g | 245,- | 354-046 | 240,- | 354-04 | 73,- | 962-617 |
| 1 g - 500 g | 285,- | 354-056 | 300,- | 354-05 | 82,- | 962-618 |
| 1 g - 1 kg | 380,- | 354-066 | 440,- | 354-06 | 90,- | 962-619 |
| 1 g - 2 kg | 600,- | 354-076 | 630,- | 354-07 | 108,- | 962-620 |
| 1 g - 5 kg | 820,- | 354-086 | 910,- | 354-08 | 116,- | 962-621 |
| 1 g - 10 kg | 2100,- | 354-096 | 1290,- | 354-09 | 126,- | 962-622 |

Class M3 · Individual weights, knob shape

Test weight material: finely turned stainless steel

| Weight | Tol +/- mg | Individual weight, knob shape | | Plastic box | | Aluminium protected box | | Wooden box | | DAkkS certificate | |
|--------|------------|-------------------------------|-------------|-------------|-------------|-------------------------|-------------|-------------|-------------|-------------------|-------------|
| | | KERN | € | KERN | € | KERN | € | KERN | € | KERN | € |
| 1 g | 10 | 367-01 | 7,60 | 347-030-400 | 2,- | 317-010-600 | 13,- | 337-010-200 | 21,- | 962-631 | 18,- |
| 2 g | 12 | 367-02 | 7,70 | 347-030-400 | 2,- | 317-020-600 | 15,- | 337-020-200 | 17,- | 962-632 | 18,- |
| 5 g | 16 | 367-03 | 7,80 | 347-030-400 | 2,- | 317-030-600 | 14,- | 337-030-200 | 18,- | 962-633 | 18,- |
| 10 g | 20 | 367-04 | 8,20 | 347-050-400 | 2,- | 317-040-600 | 13,- | 337-040-200 | 18,- | 962-634 | 18,- |
| 20 g | 25 | 367-05 | 14,- | 347-050-400 | 2,- | 317-050-600 | 13,- | 337-050-200 | 18,- | 962-635 | 18,- |
| 50 g | 30 | 367-06 | 15,- | 347-070-400 | 2,- | 317-060-600 | 12,- | 337-060-200 | 20,- | 962-636 | 18,- |
| 100 g | 50 | 367-07 | 18,- | 347-070-400 | 2,- | 317-070-600 | 13,- | 337-070-200 | 22,- | 962-637 | 20,- |
| 200 g | 100 | 367-08 | 24,- | 347-080-400 | 2,10 | 317-080-600 | 13,- | 337-080-200 | 24,- | 962-638 | 20,- |
| 500 g | 250 | 367-09 | 34,- | 347-090-400 | 3,- | 317-090-600 | 17,- | 337-090-200 | 28,- | 962-639 | 20,- |
| 1 kg | 500 | 367-11 | 57,- | 347-110-400 | 3,80 | 317-110-600 | 25,- | 337-110-200 | 43,- | 962-641 | 20,- |
| 2 kg | 1000 | 367-12 | 92,- | 347-120-400 | 5,- | 317-120-600 | 32,- | 337-120-200 | 41,- | 962-642 | 21,- |

Class M3 · Individual weights, knob and cylindrical shape

Test weight material: lacquered cast iron

| Weight | Tol +/- g | Individual weight, knob and cylindrical shape | | DAkkS certificate | |
|---------|-----------|---|--------------|-------------------|-------------|
| | | KERN | € | KERN | € |
| 100 g* | 0,05 | 366-91 | 12,- | 962-637 | 20,- |
| 200 g* | 0,10 | 366-92 | 13,- | 962-638 | 20,- |
| 500 g** | 0,25 | 366-93 | 18,- | 962-639 | 20,- |
| 1 kg** | 0,50 | 366-94 | 22,- | 962-641 | 20,- |
| 2 kg** | 1,0 | 366-95 | 31,- | 962-642 | 21,- |
| 5 kg** | 2,5 | 366-96 | 63,- | 962-643 | 21,- |
| 10 kg** | 5,0 | 366-97 | 102,- | 962-644 | 21,- |



Class M3 · Block weights

Block weight material: lacquered cast iron, surface and edges machined or unmachined (ECO)

| Weight | Tol +/- g | Block weight | ECO block weight | | Aluminium protected box | | DAkkS certificate | | |
|--------|-----------|--------------|------------------|--------|-------------------------|-------------|-------------------|---------|-------------|
| | | | € | KERN | € | KERN | € | KERN | |
| 5 kg | 2,5 | 366-86 | 69,- | 366-76 | 61,- | 346-060-600 | 71,- | 962-643 | 21,- |
| 10 kg | 5,0 | 366-87 | 116,- | 366-77 | 97,- | 346-070-600 | 95,- | 962-644 | 21,- |
| 20 kg | 10 | 366-88 | 205,- | 366-78 | 177,- | 346-080-600 | 125,- | 962-645 | 26,- |
| 50 kg | 25 | 366-89 | 495,- | 366-79 | 430,- | 346-090-600 | 83,- | 962-646 | 29,- |

Class M3 · Weight sets, knob and cylindrical shape

Test weight material: ≤ 50 g stainless steel, ≥ 100 g lacquered cast iron

| Weight | Knob and cylindrical shape, DAkkS certificate in wooden block | | | |
|-------------|---|--------------|---------|--------------|
| | KERN | € | KERN | € |
| 1 g – 1 kg | 362-96 | 240,- | 962-619 | 90,- |
| 1 g – 2 kg | 362-97 | 340,- | 962-620 | 108,- |
| 1 g – 5 kg | 362-98 | 485,- | 962-621 | 116,- |
| 1 g – 10 kg | 362-99 | 590,- | 962-622 | 126,- |



Weight set
1 g – 10 kg

Tweezers, weight grips, gloves, dusting brush



Tweezers

to be able to safely grip small test weights

| For class | For weight | Length | Version | KERN | € |
|-----------|--------------|--------|---|---------|------|
| E1 - M3 | 1 mg - 200 g | 105 mm | 1 Stainless steel with silicone-coated tips | 315-243 | 25,- |
| E1 - M3 | 500 g - 2 kg | 250 mm | 1 Stainless steel with silicone-coated tips | 315-245 | 68,- |
| E1 - M3 | ≤ 5 g | 130 mm | 2 Stainless steel, curved, high-quality plastic tips | 315-246 | 4,10 |
| E1 - M3 | ≤ 5 g | 136 mm | 3 Stainless steel, straight, high quality plastic tips | 315-247 | 4,10 |
| E1 - M3 | ≤ 200 g | 225 mm | 4 Stainless steel, straight, high-quality plastic tips, with a special shape for gripping weights of various shapes and sizes | 315-248 | 36,- |
| F2 - M3 | 1 mg - 200 g | 100 mm | 5 Stainless steel | 335-240 | 16,- |
| E1 - M3 | 1 mg - 200 g | 100 mm | 6 Plastic | 315-242 | 5,35 |

Weight grip

plastic coated

| For class | For knob shaped weights | KERN | € |
|-----------|-------------------------|---------|------|
| E1 - M3 | 2 kg | 315-273 | 32,- |
| E1 - M3 | 5 kg | 315-274 | 36,- |
| E1 - M3 | 10 kg | 315-275 | 41,- |
| E1 - M3 | 20 kg | 315-276 | 61,- |



1 not appropriate for cast iron weights



Gloves

Cotton, 1 pair. Help to protect the test weights when being used daily, from grease from fingers, damp etc.
Suitable for test weights up to 2 kg.

| KERN | € |
|---------|------|
| 317-280 | 4,60 |

Gloves

Leather/cotton, 1 pair. Help to protect the test weights when being used daily, from grease from fingers, damp etc.
Ideal for test weights from 2 kg.

| KERN | € |
|---------|------|
| 317-290 | 6,60 |

Premium gloves

Nylon, 1 pair.
Particularly elastic, one size fits all, with special fingertip coating to ensure a safe grip. Helps to protect the test weights in everyday use from grease from fingers, damp etc.
Ideal for all test weights.

| KERN | € |
|---------|-----|
| 317-281 | 9,- |



Dusting brush

to clean the weights

| KERN | € |
|---------|------|
| 318-270 | 4,10 |

Bellows

for cleaning weights

| KERN | € |
|---------|------|
| 318-271 | 6,10 |

Microfibre cloth

for cleaning weights

| KERN | € |
|---------|------|
| 318-272 | 6,50 |

Boxes for individual weights



For weights ≤ 200 g, OIML class E1 - E2:
Box with lid

For weights ≥ 500 g, OIML class E1 - M3:
Box with screw cap

Box material: Plastic, lined, suitable for single weights, KERN No. 307, 316, 317, 327, 337, 347

Box material: Plastic, not lined, suitable for single weights, KERN No. 307, 316, 317, 327, 337, 347

Plastic box, lined
for single weights E1 - E2

Plastic box, not lined
for single weights E1 - M3

| For weights | KERN | € |
|---------------------|-------------|------|
| 1 - 500 mg (single) | 347-009-400 | 2,- |
| 1 - 2 g (single) | 317-020-400 | 4,80 |
| 5 g | 317-030-400 | 4,80 |
| 10 g | 317-040-400 | 4,80 |
| 20 g | 317-050-400 | 4,80 |
| 50 g | 317-060-400 | 6,30 |
| 100 g | 317-070-400 | 7,80 |
| 200 g | 317-080-400 | 7,20 |
| 500 g | 317-090-400 | 8,70 |
| 1 kg | 317-110-400 | 10,- |
| 2 kg | 317-120-400 | 13,- |
| 5 kg | 317-130-400 | 27,- |
| 10 kg | 317-140-400 | 25,- |

| For weights | KERN | € |
|-----------------------|-------------|------|
| 1 - 500 mg (single) | 347-009-400 | 2,- |
| 1 g - 5 g (single) | 347-030-400 | 2,- |
| 10 g - 20 g (single) | 347-050-400 | 2,- |
| 50 g - 100 g (single) | 347-070-400 | 2,- |
| 200 g | 347-080-400 | 2,10 |
| 500 g | 347-090-400 | 3,- |
| 1 kg | 347-110-400 | 3,80 |
| 2 kg | 347-120-400 | 5,- |
| 5 kg | 347-130-400 | 11,- |
| 10 kg | 347-140-400 | 16,- |



For weights ≤ 500 g, OIML class E1 - F1
For weights ≥ 1 kg, OIML class E1 - F1

For weights ≤ 500 g, OIML class F2 - M3
For weights ≥ 1 kg, OIML class F2 - M3

For test weights ≥ 10 kg, OIML class F1 - M1

Box material: Wood, lined, suitable for single weights, KERN No. 307, 316, 317, 326, 327

Box material: Wood, not lined, suitable for single weights, KERN No. 337, 347, 357, 367
■ not suitable for cast iron weights

Box material: Wood, lined/not lined, suitable for single weights, KERN No. 327, 337, 347
■ not suitable for cast iron weights

Wooden box, lined
for single weights E1 - F1

Wooden box, not lined
for single weights F2 - M3

Wooden box, not lined
for test weights F1 - M1

| For weights | KERN | € |
|-------------|-------------|-------|
| - | - | - |
| 1 g | 317-010-100 | 32,- |
| 2 g | 317-020-100 | 30,- |
| 5 g | 317-030-100 | 32,- |
| 10 g | 317-040-100 | 30,- |
| 20 g | 317-050-100 | 31,- |
| 50 g | 317-060-100 | 35,- |
| 100 g | 317-070-100 | 35,- |
| 200 g | 317-080-100 | 39,- |
| 500 g | 317-090-100 | 46,- |
| 1 kg | 317-110-100 | 61,- |
| 2 kg | 317-120-100 | 68,- |
| 5 kg | 317-130-100 | 101,- |
| 10 kg | 317-140-100 | 123,- |
| 20 kg | 317-150-100 | 580,- |
| 50 kg | 317-160-100 | 710,- |

| For weights | KERN | € |
|---------------------|-------------|-------|
| 1 - 500 mg (single) | 338-090-200 | 34,- |
| 1 g | 337-010-200 | 21,- |
| 2 g | 337-020-200 | 17,- |
| 5 g | 337-030-200 | 18,- |
| 10 g | 337-040-200 | 18,- |
| 20 g | 337-050-200 | 18,- |
| 50 g | 337-060-200 | 20,- |
| 100 g | 337-070-200 | 22,- |
| 200 g | 337-080-200 | 24,- |
| 500 g | 337-090-200 | 28,- |
| 1 kg | 337-110-200 | 43,- |
| 2 kg | 337-120-200 | 41,- |
| 5 kg | 337-130-200 | 85,- |
| 10 kg | 337-140-200 | 93,- |
| 20 kg | 337-150-200 | 385,- |
| 50 kg | 337-160-200 | 590,- |

| For weights | KERN | € |
|-------------|-------------|-------|
| 5 kg | 337-131-200 | 360,- |
| 10 kg | 337-141-200 | 360,- |
| 20 kg | 337-151-200 | 385,- |
| 50 kg | 337-161-200 | 590,- |

Wooden box, lined
for test weights F1

| For weights | KERN | € |
|-------------|-------------|-------|
| 5 kg | 337-131-100 | 465,- |
| 10 kg | 337-141-100 | 300,- |
| 20 kg | 337-151-100 | 325,- |
| 50 kg | 337-161-100 | 510,- |

Boxes for individual weights



For weights ≤ 5 kg, OIML class E1 – M3

Box material: Aluminium protected, lined, suitable for mg and single weights, KERN No. 307, 308, 316, 317, 318, 326, 327, 328, 337, 338, 347, 348, 357, 367

■ not suitable for cast iron weights

Aluminium protected box, lined

for individual weights, knob and compact shape, class E1 – M3

| For weights | KERN |  | € |
|---------------------|-------------|---|------|
| 1 - 500 mg (single) | 317-009-600 | | 13,- |
| 1 g | 317-010-600 | | 13,- |
| 2 g | 317-020-600 | | 15,- |
| 5 g | 317-030-600 | | 14,- |
| 10 g | 317-040-600 | | 13,- |
| 20 g | 317-050-600 | | 13,- |
| 50 g | 317-060-600 | | 12,- |
| 100 g | 317-070-600 | | 13,- |
| 200 g | 317-080-600 | | 13,- |
| 500 g | 317-090-600 | | 17,- |
| 1 kg | 317-110-600 | | 25,- |
| 2 kg | 317-120-600 | | 29,- |
| 5 kg | 317-130-600 | | 53,- |



For weights ≤ 10 kg, OIML class E1 – M3

Box material: Aluminium protected, lined, suitable for single weights, KERN No. 307, 316, 317, 326, 327, 337, 347, 357, 367

■ not suitable for cast iron weights

Aluminium protected box, lined

for individual weights, knob and compact shape, class E1 – M3

| For weights | KERN |  | € |
|-------------|-------------|---|-------|
| 10 kg | 317-140-600 | | 75,- |
| 20 kg | 317-150-600 | | 105,- |
| 50 kg | 317-160-600 | | 305,- |



For block weight ≥ 5 kg, OIML class F1 – M3

Box material: Aluminium protected, lined, suitable for block weights, KERN No. 326, 336, 346, 356, 366

Aluminium protected box, lined

for individual weights F1 – M3

| For weights | KERN |  | € |
|-------------|-------------|---|-------|
| 5 kg | 346-060-600 | | 71,- |
| 10 kg | 346-070-600 | | 95,- |
| 20 kg | 346-080-600 | | 125,- |
| 50 kg | 346-090-600 | | 83,- |

Clean room boxes



NEW



For weights ≤ 500 g, OIML class E1 – M1
For weights 1 g – 2 kg, OIML class E1 – M1

Box material: POM (Polyoxymethylen), not lined, suitable for single weights, KERN No. 307, 316, 317, 327, 337, 347

Polyoxymethylene boxes POM, unlined

for single weights E1 – M1

| For weights | KERN |  | € |
|---------------------|-------------|---|-------|
| 1 - 500 mg (single) | 317-009-700 | | 91,- |
| 1 g | 317-010-700 | | 91,- |
| 2 g | 317-020-700 | | 91,- |
| 5 g | 317-030-700 | | 91,- |
| 10 g | 317-040-700 | | 91,- |
| 20 g | 317-050-700 | | 91,- |
| 50 g | 317-060-700 | | 91,- |
| 100 g | 317-070-700 | | 91,- |
| 200 g | 317-080-700 | | 101,- |
| 500 g | 317-090-700 | | 139,- |
| 1 kg | 317-110-700 | | 185,- |
| 2 kg | 317-120-700 | | 215,- |



NEW



For weights 10 kg - 20 kg, OIML class E1 – M1
*Box with handle

Box material: POM (Polyoxymethylen), not lined, suitable for single weights, KERN No. 307, 316, 317, 327, 337, 347

Polyoxymethylene boxes POM, unlined

for single weights E1 – M1

| For weights | KERN |  | € |
|-------------|-------------|---|-------|
| 5 kg* | 317-130-700 | | 495,- |
| 10 kg* | 317-140-700 | | 670,- |
| 20 kg* | 317-150-700 | | 810,- |

Carrying cases/boxes for individual weight sets

Individual weight sets:

You can create your own "tailor-made" individual weight sets yourself.

KERN will customise your own personal wooden box/plastic carrying case.

The largest individual weight which will fit is given in the table.

Sample order:

Your individual weight set (class F1):

1 × 50 g, 2 × 100 g, 1 × 500 g, 2 × 1 kg, 1 × 2 kg.

The correct individual box is **KERN No. 313-080-400** (plastic) or **KERN No. 315-070-100** (wood, lined)



Plastic case

for individual weight sets classes E1 – M3, not appropriate for cast iron weights

| Largest possible weight | KERN |  | € |
|-------------------------|-------------|---|--------------|
| ≤ 500 g | 313-050-400 | | 77,- |
| ≤ 5 kg | 313-080-400 | | 194,- |

Wooden case

lined, for individual weight sets classes E1 – F1
* with side handles

| Largest possible weight | KERN |  | € |
|-------------------------|-------------|---|--------------|
| ≤ 200 g | 315-040-100 | | 235,- |
| ≤ 1 kg | 315-060-100 | | 340,- |
| ≤ 2 kg | 315-070-100 | | 205,- |
| ≤ 5 kg* | 315-080-100 | | 325,- |
| ≤ 10 kg* | 315-090-100 | | 360,- |

Wooden case not lined, for individual weight set classes F2 – M3, not appropriate for cast iron weights * with side handles

| Largest possible weight | KERN |  | € |
|-------------------------|-------------|---|--------------|
| ≤ 200 g | 335-040-200 | | 148,- |
| ≤ 500 g | 335-050-200 | | 148,- |
| ≤ 1 kg | 335-060-200 | | 210,- |
| ≤ 2 kg | 335-070-200 | | 205,- |
| ≤ 5 kg* | 335-080-200 | | 325,- |
| ≤ 10 kg* | 335-090-200 | | 360,- |

Carrying cases for standard weight sets



Fig. shows 313-010-600

Plastic case for weight sets

with standard denomination classes E1 – M3, not appropriate for cast iron weights

| Largest possible weight | KERN |  | € |
|-------------------------|-------------|---|--------------|
| ≤ 500 g | 313-052-400 | | 77,- |
| ≤ 5 kg | 313-082-400 | | 194,- |

Aluminium protected case

for weight sets with standard denomination classes E1 – M2
*no handle **1 front handle ***2 side handles

| For weights | For class | KERN |  | € |
|---------------|-----------|----------------|---|--------------|
| 1 mg - 500 mg | E1 - M1 | 313-010-600* | | 65,- |
| 1 mg - 50 g | E1 - M1 | 313-020-600* | | 94,- |
| 1 mg - 100 g | E1 - M1 | 313-030-600* | | 103,- |
| 1 mg - 200 g | E1 - M1 | 313-040-600* | | 109,- |
| 1 mg - 500 g | E1 - M1 | 313-050-600* | | 132,- |
| 1 mg - 1 kg | E1 - M1 | 313-060-600* | | 161,- |
| 1 mg - 2 kg | E1 - M1 | 313-070-600** | | 189,- |
| 1 mg - 5 kg | E1 - M1 | 313-080-600*** | | 250,- |
| 1 mg - 10 kg | E1 - M1 | 313-090-600*** | | 330,- |
| 1 g - 50 g | E1 - M2 | 314-020-600* | | 89,- |
| 1 g - 100 g | E1 - M2 | 314-030-600* | | 98,- |
| 1 g - 200 g | E1 - M2 | 314-040-600* | | 104,- |
| 1 g - 500 g | E1 - M2 | 314-050-600* | | 127,- |
| 1 g - 1 kg | E1 - M2 | 314-060-600* | | 156,- |
| 1 g - 2 kg | E1 - M2 | 314-070-600* | | 184,- |
| 1 g - 5 kg | E1 - M2 | 314-080-600*** | | 245,- |
| 1 g - 10 kg | E1 - M2 | 314-090-600*** | | 330,- |

Weight containers for rectangular weights or other test weights, stainless steel glass bead blasted, adjusted to OIML class M1

Preconfigured weight containers for testing high-load floor scales, pallet scales, pallet truck scales, crane scales, etc. This can also be used for storing the weights. This means the weight container and the weights can be placed on the balance in one go, saving you time and money. The weight container is adjusted to OIML accuracy class M1. Other OIML accuracy classes are also available, please ask.

| Weight of the weight container, OIML class M1 | Tol +/- g | Possible equipment, rectangular weights, OIML class M1 | Maximum total weight (weight container incl. weights) | Price (weight container excluding weights) | |
|---|-----------|--|---|--|--------|
| | | | | KERN | € |
| 20 kg | 1,0 | 5 × 20 kg | 120 kg | 346-022-005 | 1610,- |
| 40 kg | 1,5 | 8 × 20 kg | 200 kg | 346-042-008 | 2070,- |
| 50 kg | 2,5 | 10 × 20 kg | 250 kg | 346-052-010 | 2070,- |
| 50 kg | 2,5 | 4 × 50 kg | 250 kg | 346-055-004 | 2070,- |
| 50 kg | 2,5 | 9 × 50 kg | 500 kg | 346-055-009 | 2070,- |
| 60 kg | 3,0 | 8 × 50 kg and 2 × 20 kg | 500 kg | 346-065-009 | 2250,- |

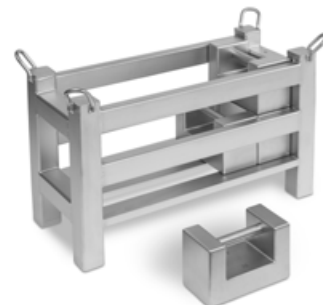

| Weight of the weight container, OIML class M1 | Tol +/- g | Possible equipment, test weights, OIML class M1 | Maximum total weight (weight container incl. weights) | Price (weight container excluding weights) | |
|---|-----------|---|---|--|--------|
| | | | | KERN | € |
| 20 kg | 1,0 | max. 10 × 10 kg or 5 × 20 kg | 120 kg | 347-022-005 | 1610,- |
| 40 kg | 2,0 | max. 16 × 10 kg or 8 × 20 kg | 200 kg | 347-042-008 | 1890,- |
| 50 kg | 2,5 | max. 20 × 10 kg or 10 × 20 kg | 250 kg | 347-052-010 | 2070,- |
| 60 kg | 3,0 | max. 22 × 20 kg | 500 kg | 347-062-022 | 2250,- |



Individual weight containers for rectangular weights or other test weights, calibrated to OIML class M1

Individual weight carriers for testing high capacity floor scales, pallet scales, pallet truck scales, crane scales, etc. This can also be used for storing the weights. This means the weight container and the weights can be placed on the scale in one go, saving time and money.

The weight container can be calibrated to OIML accuracy classes M1 – M3. On request, KERN will make you a “tailor-made” weight carrier to your specifications.

Example:

| | | | |
|--------------------|----------------------|---|--------|
| 3 block weights | each 50 kg, class M1 | = | 150 kg |
| 1 weight container | each 50 kg, class M1 | = | 50 kg |
| Total | | = | 200 kg |

| Weight of the weight container, OIML class M1 | Price | |
|---|-------------|--------|
| | KERN | € |
| Individual weight container for rectangular weights | 346-000-000 | 1700,- |
| Individual weight container for test weights | 347-000-000 | 1700,- |



Example illustration

18



ACCREDITED CALIBRATION, VERIFICATION SERVICE

The DAkkS (German accreditation body)

The DAkkS is the national accreditation body of the Federal Republic of Germany. According to Regulation (EC) No. 765/2008 and the Accreditation Body Act (AkkStelleG), the DAkkS acts in the public interest as the sole service provider for accreditation in Germany.

In order to be able to fulfil its sovereign accreditation tasks, the DAkkS was entrusted by the Federal Government. As an entrusted body, the DAkkS is subject to federal supervision.

Only an accredited calibration laboratory can issue a DAkkS calibration certificate. This defines not only the measuring method as well as the measuring result, but also gives information on tracing the test medium to national standards and the relevant uncertainty of measurement.

-
- > **You are certified to ...**
ISO 9001, QS 9000, GLP, GMP, TS16949
 - > **You need ...**
to control your measuring equipment
 - > **Our solution ...**
DAkkS calibration certificate; (traceability, measuring uncertainty, internationally recognised)
-

KERN – Precision is our business

The KERN calibration laboratory for electronic balances and weights has been accredited by DKD since 1994 and today is one of the most modern and best-equipped DAkkS calibration laboratories for balances, test weights and force measurement in Europe.

Thanks to the high level of automation, we can carry out DAkkS calibration of balances, test weights and force-measuring devices 24 hours a day, 7 days a week.

Do you have any further requests or questions on this matter? We would be pleased to help you or visit us on the web at www.kern-lab.com

Accredited calibration

Why? DAkkS calibration is always necessary when checking equipment (balance or test weight) is to be used in a QM process (e.g. to ISO 9000ff, GS 9000, TS 16949, VDA 6.1, FDA, GLP, GMP, GMP etc.)

What? Any checking equipment in proper condition can be DAkkS calibrated

How? Determination of accuracy throughout the world by a laboratory which is accredited to DIN EN ISO 17025. Traceability to internationally recognised standards. The DAkkS calibration certificate confirms both the measurement characteristics of the checking equipment and the general requirements for the control of checking equipment.

Where? Internationally recognised – this is monitored by ILAC (International Laboratory Accreditation Cooperation) and e.g. DAkkS (German calibration service) in Germany

When? The operator control the use of checking equipment and periodic recalibration time intervals themselves

Range of services:

Area accredited by DAkkS:

- DAkkS calibration of balances with a maximum load of up to 50.000 kg
- DAkkS calibration of weights in the range of 1 mg – 2.500 kg. Calibrations can be carried out in the following classes: E1, E2, F1, F2, M1, M2, M3
- DAkkS calibration of force gauges and force transducers
- Volume determination for weights of accuracy class E1
- DAkkS calibration of temperature and humidity sensors

Area offered as factory calibration:

- Measuring of sensitivity (magnetic characteristics)
- Factory calibration in various sizes: Force (sensors and measuring devices), hardness (Shore, UCI, Leeb, etc.), thickness of coatings and walls, torque wrench testing devices, and much more
- Conformity assessments and recalibration of balances and weights at the KERN verification point, working closely with the verification authorities.

And on top of all these services, we also offer additional services.

Balance & weight in the quality management system

Do you already use all the modules of the KERN precision package for maximum accuracy and reliability of your balance?

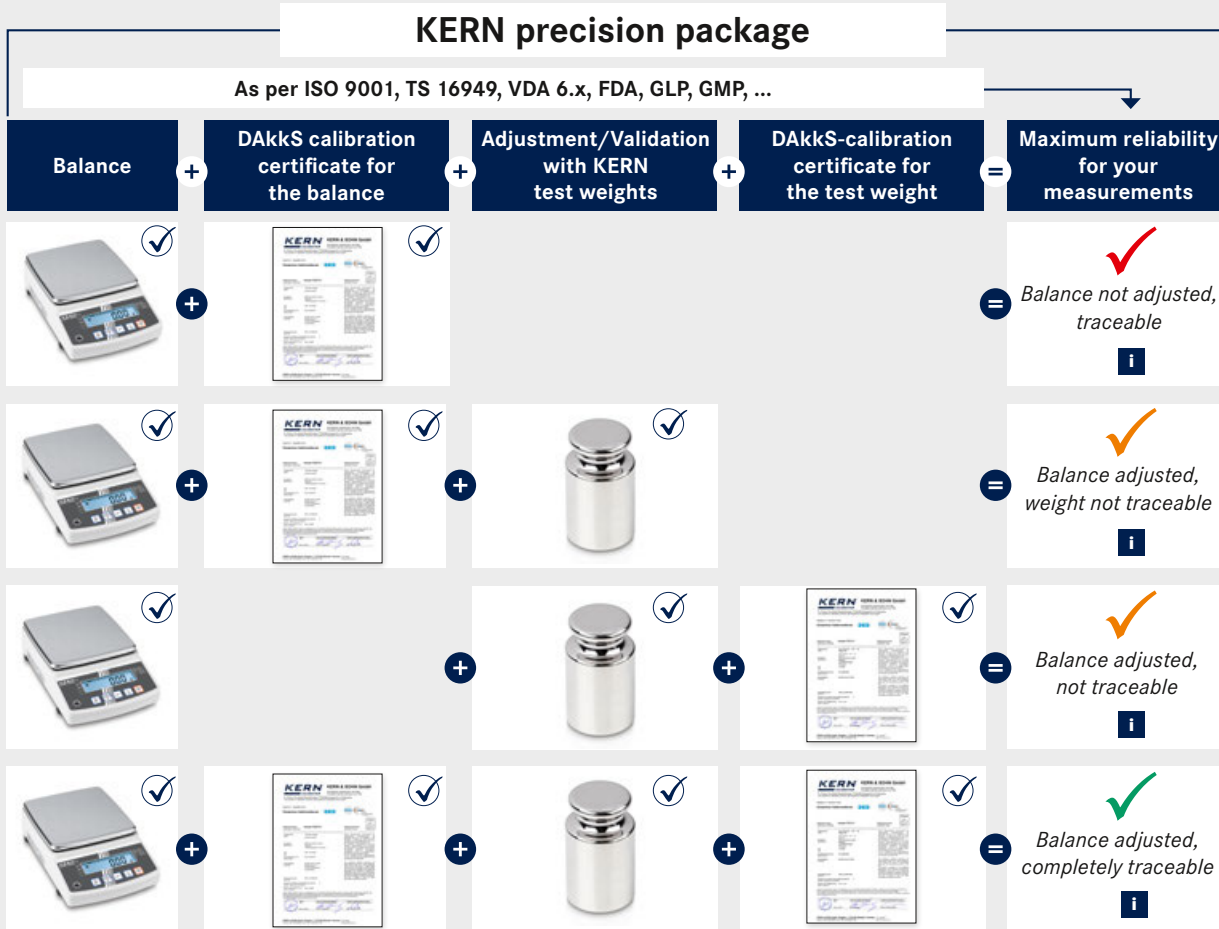

Information and ordering:
kern-sohn.com/qmb

The KERN calibration laboratory (D-K-19408-01-00)

KERN has a highly-automated DAkkS laboratory with accreditation to DIN EN ISO/IEC 17025 in numerous fields.

By using the most modern calibration technology with high-end calibration robots in fully air-conditioned laboratories, the measurement uncertainty and process times are reduced to a minimum, and also the quality of the calibration is increased.

As an accredited and certified calibration service provider with decades of experience, KERN offers you an extensive range of services, which will leave no demand unfulfilled. The accreditation applies to the extent specified in the appendix to the certificate D-K-19408-01-00.

We offer the following services:

Balances

- ▶ Accredited calibration up to 50 t
- ▶ Minimum sample weight (in use)
- ▶ Usage accuracy
- ▶ Adjustment at the location of installation
- ▶ Certificate of conformity
- ▶ Equipment qualification:
 - > Design qualification (DQ)
 - > Installation qualification (IQ)
 - > Function qualification (OQ)
 - > Performance qualification (PQ)
 - > Maintenance qualification (MQ)
- ▶ Conformity assessment/Verification

Weights

- ▶ Accredited calibration up to 2.5 t (OIML classes E1 – M3)
- ▶ Volume determination for OIML class E1
- ▶ Measuring of sensitivity (magnetic characteristics)
- ▶ Verification (where possible)

Force measuring devices and force transducers

- ▶ Accredited calibration up to 5 kN

Temperature and humidity sensors

- ▶ Accredited calibration up to 50 °C resp. 75 %

Factory calibration for

- ▶ Force measuring devices and force transducers ≤ 250 kN
- ▶ Hardness
- ▶ Layer thickness
- ▶ Material thickness
- ▶ Temperature of moisture analysers

Our commitment to satisfy our customers never stops. Perhaps this is one of the reasons why our roots can perhaps be traced so far back in history. **Discover the KERN route to success: fast – competent – reliable – versatile!**

The order process

- 1 You will receive a **reminder** that your test equipment is due or you will generate online a quotation for new or existing test equipment
- 2 Submission or collection of your test equipment
- 3 Initial inspection of your goods, to check that they are suitable for calibration, and are complete, etc.
- 4 You will get a detailed **order confirmation**
- 5 Our experts will carry out **initial calibration**
- 6 Checked for conformity with required tolerances and if required, any **necessary actions** which arise from this are carried out
- 7 Before these actions are carried out, we will contact you (in so far as no **individual processing** has been agreed with you beforehand)
- 8 After your **approval** the necessary actions will be implemented and the calibration will be completed
- 9 After that your **test equipment will be returned** to you without delay, together with the appropriate calibration certificates
- 10 We will **monitor your recalibration periods** and will send you a reminder about your next calibration, free of charge

Our service

► Reminder service

The continuous cyclic recalibration of your checking equipment is an integral part of the reliable management of test equipment. You can rely on us to support you, and we will remind you in time, free of charge, when the next recalibration is due. In addition, you have the option of managing your test equipment online by yourself (cf. 1, 10).

► Quote generator

You will be impressed by our price-to-performance ratio. Request a non-binding quotation or create it yourself to suit your specifications at www.kern-lab.com (cf. 1)

► Collection service

We will be pleased to arrange a pick up by our forwarding agent the goods from your premises. You only need to tell us the weight and dimensions of your package and leave the rest to us (cf. 2)

► Repair and reconditioning of balances and weights

KERN will get your weights back up to standard, regardless of the manufacturer. Whether it is adjustment, marking, sand blasting or lacquering – the aim here is compliance and long-term stability. Any repairs of balances and instruments which may be necessary can be carried out quickly and easily (cf. 5, 6)

► Individual processing

In order to avoid delays with future orders, we would be pleased to incorporate your individual requirements for future processing of such calibration results. Even for smaller issues such as the printing of calibration certificates (stapling, punching, double-sided) we can work to your requirements (cf. 8).

► Express service and dispatch

If you need a particularly fast service, you can use your DAKkS express service. You will receive your test equipment after only 2 days (cf. 9).

www.kern-lab.com – the central portal for everything you need to know about the extensive KERN calibration services

On our website you will always find the latest news and useful information about testing and measuring devices, calibration, legal metrology and expansions to our range of services. You will also find numerous online services on the website.

Database supported management of test equipment

Information on your test equipment which has been calibrated by us is stored in our database. In this way it is possible to make trend calculations. You will therefore get an overview about the long-term stability and trend behaviour of your test equipment as well as the necessary recalibration period can easily be determined and specified.

Paperless documentation

So there is no administrative effort, we can handle all calibration documentation in a paperless process. From quotation, through to order confirmation, delivery note and invoice right up to calibration certificate, you will receive all documents by e-mail or you can retrieve them online. Would you prefer to receive your certificate or your invoice in paper form, for example? Of course this is not a problem either.

We will send you everything you require by post.

Calibration certificate download

By using our download service you can easily download your calibration certificates as soon as the calibration work is complete and you will have access to them at any time in the future. Simply create your user account on www.kern-lab.com and you will never have to look for your certificates again.

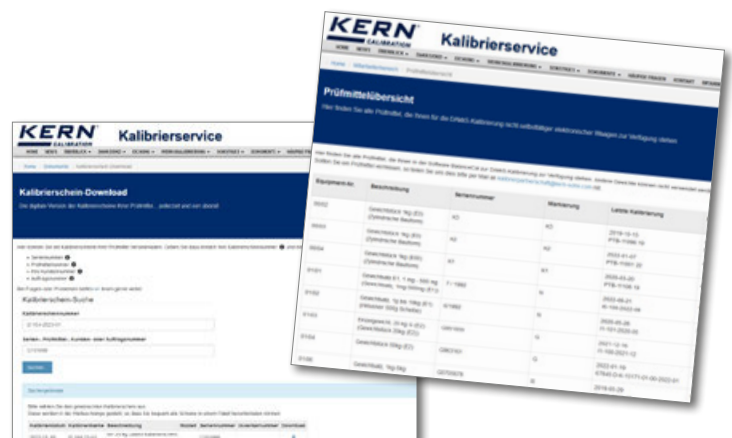

Accredited Calibration of Balances

Any balance will only give correct results if it is checked regularly, i.e. calibrated correctly and adjusted when required. A balance is only a reliable measuring and checking tool if it is calibrated and this calibration is documented. The issued calibration certificates with accreditation symbol are proof of the metrological traceability to national and international standards, as required by the DIN EN ISO 9000 and DIN EN ISO/IEC 17025 standards, amongst others. KERN recommends a recalibration period of one year. The standard does not give a defined recalibration period. KERN recommends that, with intensive (daily) use, you to recalibrate your balance every 6 months and at normal (weekly) use, every 12 months.



The advantages of using on-site calibration:

- + **Calibration on-site** at your premises in the field of use
- + **Minimisation of measurement uncertainty** and guarantee of process accuracy strictly according to guideline EURAMET cg-18
- + **No risk of damage** during transportation
- + **Low downtime**
- + **Direct and personal contact** with the service technician
- + **Cross-brand servicing**, basic inspection and adjustment by a specialist
- + You tell us **when you would like us to come**
- + **Device training** for qualified users



a) KERN on-site calibration (we visit you)

In Germany, KERN has a close-knit network of KERN DAkkS calibration laboratory employees, who can carry out on-site calibration of balances up to 50 tonnes.

This on-site testing service is metrologically recommended, as your balance is in its field of use and can be calibrated without any possible transportation problems.

Lower downtime and personal contact with our expert are the major benefits of this service.

Preparatory maintenance work by agreement. Prices for on-site calibration on request.

You tell us when you would like us to come, giving us details of the balances to be tested. Our on-site DAkkS calibration team will then get in touch with you immediately and will discuss the process with you at your premises – it's straight forward and professional.

This KERN calibration service is also independent of the brand.

Please feel free to contact us at Phone +49 7433 9933-400 or E-Mail: testservices-onsite@kern-sohn.com



The advantages of using in-house calibration:

- + **Short calibration time:** Test time in the laboratory is only four working days
- + **Competence:** Calibration laboratory, which complies with the highest standards in the area of metrology
- + **Independent management** of the recalibration calendar for your individual measuring instrument is possible
- + **Cross-brand service:** Measuring devices from any manufacturer can be calibrated independently
- + **Repair:** Any necessary repairs can be carried out immediately, if you wish



b) Calibration at the KERN factory (you send your balance to us)

Recommended for new devices and for balances which can be affordably transported, as then there is no need for us to travel to carry out the calibration on-site. Repairs can be carried out at the same time, quickly and in full.

The process would be as follows:

- Day 1: Send your balance to the KERN calibration laboratory in Balingen.
- Day 2 to 3: Evaluation and calibration of your balance by our specialists.
- Day 4: After positive validation, your balance is returned.

Please feel free to contact us at Phone +49 7433 9933-400 or E-Mail: recalibration-balances@kern-sohn.com

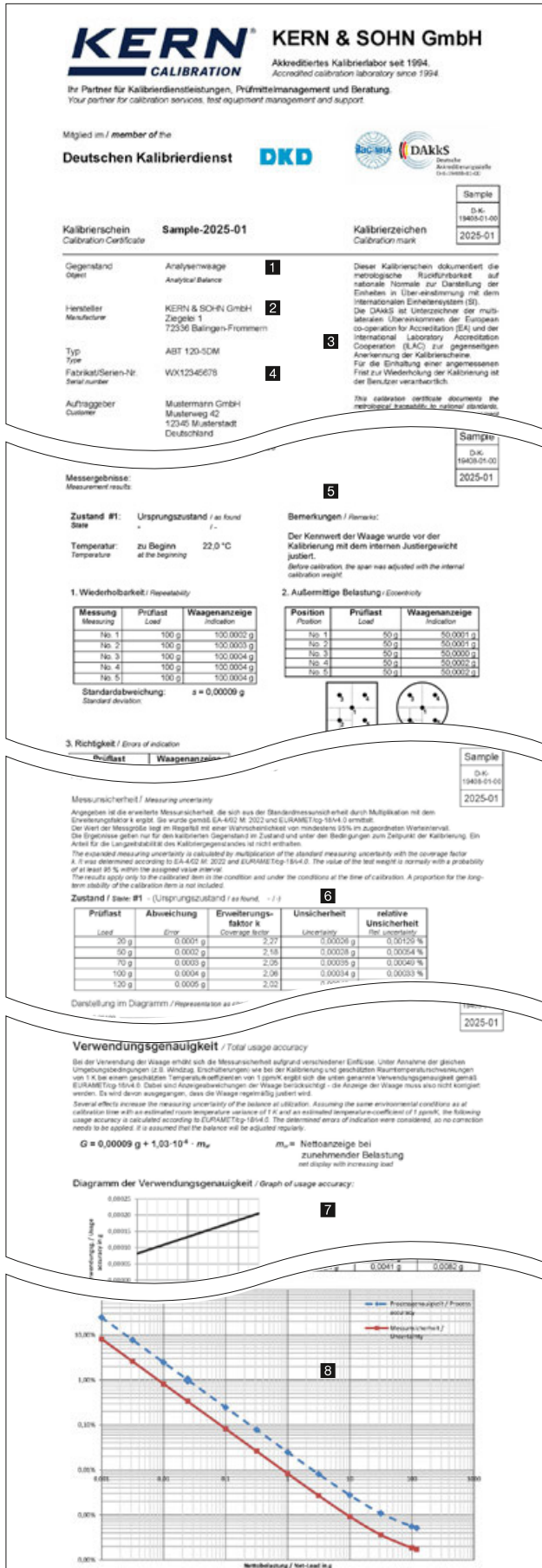

To get reliable weighing results you need to have calibrated balances. KERN offers you an extensive calibration service for your balances – You have the choice:

Recalibration

- The recalibration schedule depends on the frequency of use, the conditions of use and the safety requirements.
- We would recommend that you recalibrate your balances every 6 months if they are used intensively, and every 12 months with normal use.
- The KERN calibration service is independent of the brand.



Initial calibration and recalibration of balance at the KERN factory

KERN

Price excl. of VAT ex works €

| Weighing capacity | | |
|--|--|--|
| Analytical balances | | |
| [Max] ≤ 5 kg | 963-101 | 200,- |
| [Max] > 5 kg | 963-102 | 250,- |
| Precision balances/Industrial scales | | |
| [Max] ≤ 5 kg | 963-127 | 103,- |
| [Max] > 5 kg – 50 kg | 963-128 | 124,- |
| [Max] > 50 kg – 350 kg | 963-129 | 153,- |
| [Max] > 350 kg – 1500 kg | 963-130 | 215,- |
| [Max] > 1500 kg – 2900 kg ¹⁾ | 963-131 | 290,- |
| [Max] > 2900 kg – 6000 kg ¹⁾ | 963-132 | 580,- |
| [Max] > 6000 kg – 12000 kg ¹⁾ | 963-133 | 650,- |
| Hanging scales/Crane scales | | |
| [Max] ≤ 5 kg | 963-127H | 103,- |
| [Max] > 5 kg – 50 kg | 963-128H | 124,- |
| [Max] > 50 kg – 350 kg | 963-129H | 145,- |
| [Max] > 350 kg – 1500 kg | 963-130H | 255,- |
| [Max] > 1500 kg – 2900 kg | 963-131H | 395,- |
| [Max] > 2900 kg – 6000 kg | 963-132H | 650,- |
| [Max] > 6000 kg – 12000 kg ³⁾ | 963-133H | 910,- |
| Preparation for recalibration (cleaning, function test) | 969-003R | 26,- |
| Additional services | | |
| Minimum weight of sample (for details see page 221) | 969-103 | 10,- |
| Additional measurement points (as part of the) weighing test | 963-140 | 5,50/ measurement point |
| Additional measurement points (as part of the) repeatability testing | 963-140 | 5,50/ each further measurement point |
| Express service with delivery time 48 hours (only on initial purchase) | 962-116 | 52,-/ scale |
| Express shipping: Express supplement for guaranteed delivery on the next working day (if ready for shipment before 12:00 noon) | in GER only <small>(other countries on request)</small> | 40,-/ parcel |

¹⁾ Floor scales & axle load scales only (Price per weighing panel). Please ask for further details.
²⁾ On request
³⁾ Processing time 4 working days
⁴⁾ Processing time 15 working days

18 Calibration certificate with accreditation symbol for balances (extract)

- 1 Official document
- 4 Identification/Applicant
- 7 Application accuracy, see the *Glossary*
- 2 Item to be calibrated
- 5 Metrological component
- 8 Minimum weight of sample (additional price)
- 3 Traceability, see the *Glossary*
- 6 Uncertainty of measurement, see the *Glossary*

Minimum weight of sample (in use)

What is the lightest item you can weigh on your balance, while still achieving accurate and reliable weighing results? What exactly is the limit?

The KERN minimum sample weight protocol accounts for the established minimum sample weight of your balance and its location of installation and use with the relative measuring uncertainty. With various safety coefficients and required weighing accuracy (process accuracy), depending on standard or quality-related requirements on the balance being used.

The higher the selected safety coefficient, the higher the safety when using the balance in a particular process.

Typical perturbations when using the balance e.g. small fluctuations in temperature are taken into account. In easily predictable conditions in a professional environment of use, KERN recommends a safety coefficient of 3. For critical processes, a correspondingly higher factor should be selected. The minimum sample weight protocol contains a diagram as well as a table, from which you can ascertain the minimum sample weight for your balance, depending on the process.

Adjustment at the location of installation

Why?

Adjustment at the location of installation is necessary, as the measuring results of balances depend on the local gravitational force (gravitational acceleration) and therefore depend on the location of use. KERN can carry this out just before shipping at the factor, individually to suit the location of installation.

What are the advantages of carrying out adjustment at the location of installation?

- The balance gives reliable measurement results at the location of installation.
- No time-consuming on-site adjustment necessary.
- You do not need a Service Engineer or any additional weights.
- The balance is ready for immediate use.

Pricing table* for adjustment at the location of installation

| Weighing capacity | KERN | Price excl. of VAT ex works € |
|-------------------------|---------|--|
| [Max] ≤ 5 kg | 961-247 | 43,- |
| [Max] > 5 - 50 kg | 961-248 | 52,- |
| [Max] > 50 - 350 kg | 961-249 | 62,- |
| [Max] > 350 - 1500 kg | 961-250 | 99,- |
| [Max] > 1500 - 2900 kg | 961-251 | 131,- |
| [Max] > 2900 - 6000 kg | 961-252 | 260,- |
| [Max] > 6000 - 12000 kg | 961-253 | 300,- |

For adjustment to the location of installation you need the value for gravitational acceleration at the location of installation, which KERN can calculate using the point of use. The procedure is suitable for balances with a resolution of <60,000 d. For higher resolutions we recommend a balance with an internal adjusting weight or adjustment with a calibrated adjusting weight at the location of installation.

Certificate of conformity

With a certificate of conformity you get a statement about whether the balance meets your defined requirements. In conjunction with a calibration certificate with accreditation symbol it serves as documented proof that the balance fulfils the required process demands. When doing this the process owner for the balance can select from different temperature specifications – depending on its individual requirements:

| Conformity evaluation on the basis of the: | KERN | Price excl. of VAT ex works € |
|--|----------------------------|--|
| Usage accuracy* | relative | 969-511 |
| | absolute | 969-512 |
| Calibration results* | relative | 969-513 |
| | absolute | 969-514 |
| Measurements as manufacturer or customer specification | Foreign device | 969-515 |
| | Customer specifications | 969-516 |
| | KERN devices | 969-517 |

relative = % / absolute = g *as attachment to the calibration certificate with accreditation symbol
(Details see www.kern-lab.com)

Example for absolute customer tolerance (absolute) (Item no. 969-511):

| No. | Tare | Load | Display | Deviation | Uncertainty | Customer tolerance | Conformity ¹⁾ |
|-----|------|--------|-----------|-----------|-------------|--------------------|--------------------------|
| 1 | 0 g | 500 g | 500,00 g | 0,00 g | ± 0,013 g | ± 0,05 g | ☑ |
| 2 | 0 g | 1000 g | 1000,00 g | 0,00 g | ± 0,015 g | ± 0,05 g | ☑ |
| 3 | 0 g | 1500 g | 1500,01 g | 0,01 g | ± 0,017 g | ± 0,05 g | ☑ |
| 4 | 0 g | 2000 g | 2000,01 g | 0,01 g | ± 0,020 g | ± 0,10 g | ☑ |
| 5 | 0 g | 3000 g | 3000,02 g | 0,02 g | ± 0,022 g | ± 0,10 g | ☑ |

¹⁾Evaluation criteria: |[Deviation]| + [extended measuring uncertainty] ≤ [tolerance]

Documented quality of your balances in the log book

Consistently high product quality requires the use of measuring and test equipment that provides comprehensible, consistent and reproducible results. Hence, quality management systems require that measuring and test equipment produces a detailed traceable description and documentation of calibration results and conformity statements. According to the guiding principle of GMP/GLP: "Work not documented is work not done."

Equipment qualification is documentary evidence that a equipment is suitable for the intended purpose and is working faultlessly. A balance log book as well as our EQS (Equipment Qualification Software) is used to record all activities and results required for the qualification and monitoring of balances during routine operation. This includes the installation and commissioning of the balances, routine tests, maintenance as well as the recording of special events (failures, repairs, change of location).

The structure of the balance log book is based on the qualification process of the balance. The requirements for the qualification system such as DIN EN ISO 9001, DIN EN ISO/IEC 17025, GLP/GMP, VDA must be taken into account. The log book supports the user in his/her daily work with the balance and is meant to serve as necessary evidence during inspections and audits. The responsibility for maintaining the log book and its appropriate use is to be borne by the user.

Our proposal: Count on our support!

KERN offers this qualification concept throughout. Our validation services are carried out on the spot by technicians of our calibration laboratory and comprise among other things: installation, measurement test inclusive DAkks calibration certificate as well as records in your qualification log book of the EQS software (Equipment Qualification Software).

We give you advice about the options of device qualification, as required and will be happy to set up an appointment for qualification at the place of installation.

We offer individual calibration and maintenance agreements for the periodically required requalification.

Further information can be found at www.kern-lab.com



Important elements of equipment qualification:



Design qualification (DQ)

With the design qualification, which is carried out under consideration of a requirement specification/functional description, all the requirements on which you as a user depend on, are defined. The purchase decision is made on the basis of the design specifications and the available devices. Careful selection in the DQ can prevent subsequent deficiencies.



Installation qualification (IQ)

During the installation qualification based on a FMEA, we perform a documented installation, up to the qualified commissioning of your device. Points of this qualification are:

- Scope of delivery and identification
- Visual inspection of the system components
- Evaluation of the installation site
- Hardware installation and device settings
- Cleaning
- Query of work instructions during use
- Clarification of deviations
- Document review and approval

We carry out our qualifications in accordance with the GMP standard.



Function qualification (OQ)

Instruction is given to the user/s. Items of the OQ are:

- Function test of the system
- Initial adjustment on site
- Metrological verification including USP & Ph.Eur.
- Creation of test protocols
- Check of menu function and error message
- Review and approval of documents
- Evaluation of performance and determination of further test procedure



Performance qualification (PQ)

The PQ represents documented evidence that the balance or weighing system functions in the selected application as intended. This will be assured by a qualification test of the equipment under real conditions with respect to its surroundings and the problem definition (such as traceable data transmission).



Maintenance qualification (MQ)

The periodical maintenance, cleaning work and complete metrological test of the balance/weighing system is documented in the MQ by a trained authorised engineer. Maintenance is carried out with the help of a maintenance schedule. The maintenance times are determined by you. We are happy to support you with a maintenance contract for the entire organisation of your measuring system.



If you are interested in a training for equipment qualification, please feel free to contact us at **+49 7433 9933-400** or testservices-onsite@kern-sohn.com

Recalibration Price of Test Weights (Accredited Calibration)

| Class acc. | → E1 ²⁾ with volume determination | E1 ¹⁾ without volume determination | E2 ¹⁾ | F1/F2 ¹⁾ * F2 only | M1/M2/M3 ¹⁾ | | | | | |
|-----------------|---|--|------------------|-------------------------------------|------------------------|-------------------------------------|-----------|-------------------------------------|----------|-------------------------------------|
| Nominal value ↓ | KERN | Price € excl. of VAT ex works | KERN | Price € excl. of VAT ex works | KERN | Price € excl. of VAT ex works | KERN | Price € excl. of VAT ex works | KERN | Price € excl. of VAT ex works |
| 1 mg | - | - | 962-251R | 82,- | 962-351R | 36,- | 962-451R | 23,- | 962-651R | 19,- |
| 2 mg | - | - | 962-252R | 82,- | 962-352R | 36,- | 962-452R | 23,- | 962-652R | 19,- |
| 5 mg | - | - | 962-253R | 82,- | 962-353R | 36,- | 962-453R | 23,- | 962-653R | 19,- |
| 10 mg | - | - | 962-254R | 82,- | 962-354R | 36,- | 962-454R | 23,- | 962-654R | 19,- |
| 20 mg | - | - | 962-255R | 82,- | 962-355R | 36,- | 962-455R | 23,- | 962-655R | 19,- |
| 50 mg | - | - | 962-256R | 82,- | 962-356R | 36,- | 962-456R | 23,- | 962-656R | 19,- |
| 100 mg | - | - | 962-257R | 82,- | 962-357R | 36,- | 962-457R | 23,- | 962-657R | 19,- |
| 200 mg | - | - | 962-258R | 82,- | 962-358R | 36,- | 962-458R | 23,- | 962-658R | 19,- |
| 500 mg | - | - | 962-259R | 82,- | 962-359R | 36,- | 962-459R | 23,- | 962-659R | 19,- |
| 1 g | 963-231 | 250,- | 962-231R | 82,- | 962-331R | 36,- | 962-431R | 23,- | 962-631R | 19,- |
| 2 g | 963-232 | 250,- | 962-232R | 82,- | 962-332R | 36,- | 962-432R | 23,- | 962-632R | 19,- |
| 5 g | 963-233 | 250,- | 962-233R | 82,- | 962-333R | 36,- | 962-433R | 23,- | 962-633R | 19,- |
| 10 g | 963-234 | 250,- | 962-234R | 82,- | 962-334R | 36,- | 962-434R | 23,- | 962-634R | 19,- |
| 20 g | 963-235 | 250,- | 962-235R | 82,- | 962-335R | 36,- | 962-435R | 23,- | 962-635R | 19,- |
| 50 g | 963-236 | 250,- | 962-236R | 82,- | 962-336R | 36,- | 962-436R | 23,- | 962-636R | 19,- |
| 100 g | 963-237 | 250,- | 962-237R | 82,- | 962-337R | 46,- | 962-437R | 26,- | 962-637R | 21,- |
| 200 g | 963-238 | 250,- | 962-238R | 82,- | 962-338R | 46,- | 962-438R | 26,- | 962-638R | 21,- |
| 500 g | 963-239 | 250,- | 962-239R | 82,- | 962-339R | 46,- | 962-439R | 26,- | 962-639R | 21,- |
| 1 kg | 963-241 | 250,- | 962-241R | 82,- | 962-341R | 46,- | 962-441R | 26,- | 962-641R | 21,- |
| 2 kg | 963-242 | 570,- | 962-242R | 101,- | 962-342R | 55,- | 962-442R | 33,- | 962-642R | 22,- |
| 5 kg | 963-243 | 570,- | 962-243R | 101,- | 962-343R | 55,- | 962-443R | 33,- | 962-643R | 22,- |
| 10 kg | 963-244 | 570,- | 962-244R | 101,- | 962-344R | 55,- | 962-444R | 33,- | 962-644R | 22,- |
| 20 kg | 963-245 | 1320,- | 962-245R | 760,- | 962-345R | 72,- | 962-445R | 37,- | 962-645R | 29,- |
| 50 kg | 963-246 | 1540,- | 962-246R | 840,- | 962-346R | 84,- | 962-446R | 51,- | 962-646R | 31,- |
| 100 kg | - | - | - | - | - | - | 962-591R* | 152,- | 962-691R | 82,- |
| 200 kg | - | - | - | - | - | - | 962-592R* | 152,- | 962-692R | 82,- |
| 500 kg | - | - | - | - | - | - | 962-593R* | 152,- | 962-693R | 82,- |
| 1000 kg | - | - | - | - | - | - | - | - | 962-694R | 179,- |
| 2000 kg | - | - | - | - | - | - | - | - | 962-695R | 330,- |
| 1 mg-500 mg | - | - | 962-250R | 530,- | 962-350R | 250,- | 962-450R | 131,- | 962-650R | 82,- |
| 1 mg-50 g | 963-201 | 1440,- | 962-201R | 870,- | 962-301R | 410,- | 962-401R | 215,- | 962-601R | 140,- |
| 1 mg-100 g | 963-202 | 1570,- | 962-202R | 900,- | 962-302R | 450,- | 962-402R | 235,- | 962-602R | 146,- |
| 1 mg-200 g | 963-203 | 1800,- | 962-203R | 990,- | 962-303R | 510,- | 962-403R | 260,- | 962-603R | 164,- |
| 1 mg-500 g | 963-204 | 1920,- | 962-204R | 1030,- | 962-304R | 550,- | 962-404R | 270,- | 962-604R | 172,- |
| 1 mg-1 kg | 963-205 | 2040,- | 962-205R | 1110,- | 962-305R | 590,- | 962-405R | 285,- | 962-605R | 180,- |
| 1 mg-2 kg | 963-206 | 2660,- | 962-206R | 1180,- | 962-306R | 650,- | 962-406R | 330,- | 962-606R | 198,- |
| 1 mg-5 kg | 963-207 | 2980,- | 962-207R | 1230,- | 962-307R | 690,- | 962-407R | 345,- | 962-607R | 210,- |
| 1 mg-10 kg | 963-208 | 3390,- | 962-208R | 1270,- | 962-308R | 740,- | 962-408R | 375,- | 962-608R | 215,- |
| 1 g-50 g | 963-215 | 1040,- | 962-215R | 385,- | 962-315R | 169,- | 962-415R | 88,- | 962-615R | 54,- |
| 1 g-100 g | 963-216 | 1130,- | 962-216R | 420,- | 962-316R | 200,- | 962-416R | 101,- | 962-616R | 65,- |
| 1 g-200 g | 963-217 | 1380,- | 962-217R | 500,- | 962-317R | 265,- | 962-417R | 128,- | 962-617R | 80,- |
| 1 g-500 g | 963-218 | 1500,- | 962-218R | 550,- | 962-318R | 305,- | 962-418R | 143,- | 962-618R | 90,- |
| 1 g-1 kg | 963-219 | 1650,- | 962-219R | 590,- | 962-319R | 340,- | 962-419R | 157,- | 962-619R | 96,- |
| 1 g-2 kg | 963-220 | 2310,- | 962-220R | 680,- | 962-320R | 420,- | 962-420R | 197,- | 962-620R | 117,- |
| 1 g-5 kg | 963-221 | 2700,- | 962-221R | 700,- | 962-321R | 470,- | 962-421R | 215,- | 962-621R | 126,- |
| 1 g-10 kg | 963-222 | 3150,- | 962-222R | 760,- | 962-322R | 510,- | 962-422R | 240,- | 962-622R | 136,- |

¹⁾ Processing time 4 working days, ²⁾ Processing time 15 working days, ¹⁾ Preparation of reverification of balances, 969-006R, € 26,-

| Additional costs for preparation, overhaul and adjustment before the calibration | KERN | Price excl. of VAT ex works € |
|--|----------|-------------------------------|
| Preparation of weights (e.g. cleaning, etc.) | | |
| Single weight | 969-001R | 5,- |
| Weight set | 969-002R | 21,- |
| Subsequent services are carried out after confirmation | | |
| Continued overhaul of weights (e.g. wet-cleaning, markings, repair, special packaging, adjustment E1 (DAkkS only), E2 ...) | 969-005R | T & M basis |
| Adjustment, per weight only available for weights with adjustment chamber (F1- M3) | 969-010R | 15,- |
| Second calibration after adjustment or substitution, per weight | | |
| Class E1 | 969-210R | 63,- |
| Class E1 incl. volume determination | 969-211R | 230,- |
| Class E2 | 969-310R | 30,- |
| Class F1/F2 | 969-410R | 20,- |
| Class M1- M3 | 969-610R | 16,- |
| Testing of magnetic properties according to OIML R111:2004, per weight | 961-115R | 16,- |
| Calibration of NON-OIML test weights, additional price per weight | - | 8,- |

| KERN Standard Service Time* ¹ | |
|--|-----------------|
| Standard service Class E2 - M3 | 4 working days |
| Standard service Class E1, 1 mg - 500 mg, and recalibration 1 g - 10 kg with a known volume | 10 working days |
| Class E1, ≥ 1 g, incl. volume determination (new weights) | 15 working days |

¹⁾ The delivery time for recalibrations can vary depending on the order situation as well as in case of queries, bottlenecks, etc.



Express service in 48 hours
except for class E1

- Urgent order is received at KERN by 12:00 noon at the latest
- Ready for shipping at KERN within two working days, at 12:00 noon
- Return by standard parcel service or express shipping (Costs and processing time on request)
- Additional cost for Express Service, for each test weight, KERN 962-115 € 21,-
- For Express shipping

Verification Prices for Test Weights and (Crane) Scales

| Class acc. OIML R 111:2004 | → E2 ¹⁾ with verification certificate | F1 ¹⁾ with verification certificate | M1 ¹⁾ with verification certificate | | | |
|-------------------------------|--|--|--|-------------------------------------|---------|-------------------------------------|
| Nominal value ↓ | KERN | Price € excl. of VAT ex works | KERN | Price € excl. of VAT ex works | KERN | Price € excl. of VAT ex works |
| 1 mg | 952-351 | 57,- | 952-451 | 48,- | 952-651 | 34,- |
| 2 mg | 952-352 | 57,- | 952-452 | 48,- | 952-652 | 34,- |
| 5 mg | 952-353 | 57,- | 952-453 | 48,- | 952-653 | 34,- |
| 10 mg | 952-354 | 57,- | 952-454 | 48,- | 952-654 | 34,- |
| 20 mg | 952-355 | 57,- | 952-455 | 48,- | 952-655 | 34,- |
| 50 mg | 952-356 | 57,- | 952-456 | 48,- | 952-656 | 34,- |
| 100 mg | 952-357 | 57,- | 952-457 | 48,- | 952-657 | 34,- |
| 200 mg | 952-358 | 57,- | 952-458 | 48,- | 952-658 | 34,- |
| 500 mg | 952-359 | 57,- | 952-459 | 48,- | 952-659 | 34,- |
| 1 g | 952-331 | 57,- | 952-431 | 48,- | 952-631 | 34,- |
| 2 g | 952-332 | 57,- | 952-432 | 48,- | 952-632 | 34,- |
| 5 g | 952-333 | 57,- | 952-433 | 48,- | 952-633 | 34,- |
| 10 g | 952-334 | 57,- | 952-434 | 48,- | 952-634 | 34,- |
| 20 g | 952-335 | 57,- | 952-435 | 48,- | 952-635 | 34,- |
| 50 g | 952-336 | 57,- | 952-436 | 48,- | 952-636 | 34,- |
| 100 g | 952-337 | 63,- | 952-437 | 48,- | 952-637 | 34,- |
| 200 g | 952-338 | 63,- | 952-438 | 50,- | 952-638 | 34,- |
| 500 g | 952-339 | 63,- | 952-439 | 50,- | 952-639 | 34,- |
| 1 kg | 952-341 | 63,- | 952-441 | 50,- | 952-641 | 34,- |
| 2 kg | 952-342 | 71,- | 952-442 | 57,- | 952-642 | 36,- |
| 5 kg | 952-343 | 71,- | 952-443 | 57,- | 952-643 | 36,- |
| 10 kg | 952-344 | 71,- | 952-444 | 57,- | 952-644 | 44,- |
| 20 kg | 952-345 | 83,- | 952-445 | 59,- | 952-645 | 50,- |
| 50 kg | - | - | 952-446 | 70,- | 952-646 | 52,- |
| 1 mg-500 mg | 952-350 | 285,- | 952-450 | 148,- | 952-650 | 92,- |
| 1 mg-50 g | 952-301 | 460,- | 952-401 | 240,- | 952-601 | 154,- |
| 1 mg-100 g | 952-302 | 500,- | 952-402 | 260,- | 952-602 | 164,- |
| 1 mg-200 g | 952-303 | 570,- | 952-403 | 295,- | 952-603 | 183,- |
| 1 mg-500 g | 952-304 | 610,- | 952-404 | 305,- | 952-604 | 192,- |
| 1 mg-1 kg | 952-305 | 630,- | 952-405 | 320,- | 952-605 | 200,- |
| 1 mg-2 kg | 952-306 | 720,- | 952-406 | 360,- | 952-606 | 220,- |
| 1 mg-5 kg | 952-307 | 790,- | 952-407 | 395,- | 952-607 | 235,- |
| 1 mg-10 kg | 952-308 | 830,- | 952-408 | 420,- | 952-608 | 240,- |
| 1 g-50 g | 952-315 | 185,- | 952-415 | 107,- | 952-615 | 70,- |
| 1 g-100 g | 952-316 | 220,- | 952-416 | 113,- | 952-616 | 75,- |
| 1 g-200 g | 952-317 | 290,- | 952-417 | 145,- | 952-617 | 89,- |
| 1 g-500 g | 952-318 | 330,- | 952-418 | 160,- | 952-618 | 99,- |
| 1 g-1 kg | 952-319 | 355,- | 952-419 | 175,- | 952-619 | 109,- |
| 1 g-2 kg | 952-320 | 445,- | 952-420 | 220,- | 952-620 | 130,- |
| 1 g-5 kg | 952-321 | 495,- | 952-421 | 240,- | 952-621 | 142,- |
| 1 g-10 kg | 952-322 | 550,- | 952-422 | 270,- | 952-622 | 152,- |

KERN verification delivery time

| | |
|--|----------------|
| Standard verification service Class E2 - M1 | 6 working days |
|--|----------------|

| | | |
|--|------|--|
| Additional costs for preparation, overhaul and adjustment before the verification | KERN | Price excl. of VAT ex works € |
|--|------|--|

Preparation of weights (e.g. cleaning, etc.)

| | | |
|---------------|----------|------|
| Single weight | 969-008R | 5,- |
| Weight set | 969-009R | 21,- |

Subsequent services are carried out after confirmation

| | | |
|--|----------|----------------|
| Continued overhaul of weights (e.g. wet-cleaning, markings, repair, special packaging, adjustment E2 ...) | 969-005R | T & M basis |
|--|----------|----------------|

| | | |
|---|----------|------|
| Adjustment, per weight only available for weights with adjustment chamber (F1/F2 - M1) | 969-010R | 15,- |
|---|----------|------|

Verification after adjustment or substitution, per weight

| | | |
|-------------|----------|------|
| Class E2 | 969-310R | 30,- |
| Class F1/F2 | 969-410R | 20,- |
| Class M1 | 969-610R | 16,- |

Verification prices for balances

| | Reverification ²⁾ | Price excl. of VAT ex works € |
|---|------------------------------|--|
| | KERN | |
| Accuracy class I (precision balances) ¹⁾ | | |
| [Max] ≤ 5 kg ¹⁾ | 950-101R | 245,- |
| [Max] > 5 kg ¹⁾ | 950-102R | 320,- |
| Accuracy class II (precision balances) ¹⁾ | | |
| [Max] ≤ 5 kg ¹⁾ | 950-116R | 126,- |
| [Max] > 5 kg - 50 kg ¹⁾ | 950-117R | 153,- |
| [Max] > 50 kg - 350 kg ¹⁾ | 950-118R | 235,- |
| Accuracy class III-IV ¹⁾ | | |
| Bench scales and industrial scales (excl. crane scales) | | |
| [Max] ≤ 5 kg ¹⁾ | 950-127R | 120,- |
| [Max] > 5 kg - 50 kg ¹⁾ | 950-128R | 120,- |
| [Max] > 50 kg - 350 kg ¹⁾ | 950-129R | 193,- |
| [Max] > 350 kg - 1500 kg ¹⁾ | 950-130R | 285,- |
| [Max] > 1500 kg - 2900 kg ¹⁾ | 950-131R | 395,- |
| [Max] > 2900 kg - 6000 kg ¹⁾ | 950-132R | 610,- |
| Crane scales | | |
| [Max] > 50 kg - 350 kg ¹⁾ | 950-129HR | 210,- |
| [Max] > 350 kg - 1500 kg ¹⁾ | 950-130HR | 345,- |
| [Max] > 1500 kg - 2900 kg ¹⁾ | 950-131HR | 500,- |
| [Max] > 2900 kg - 6000 kg ¹⁾ | 950-132HR | 760,- |
| [Max] > 6000 kg - 12000 kg ¹⁾ | 950-133HR | 1220,- |

¹⁾ Preparation of reverification of balances, 969-006R, € 26,- ²⁾ Verification ("reverification") only in Germany

Accredited calibration with calibration certificate for force gauges

The KERN calibration laboratory is at your side when you need an accredited calibration. From the transducer to the full measuring chain, we are happy to take care of traceable calibration of your test equipment for you.

Our accreditation includes the calibration of tensile and pressure force up to 5 kN according to the standards DIN EN ISO 376 and DKD-R 3-3, each with the Newton (N) display unit for a complete measuring chain (situation A) or voltage ratio/transmission coefficient (mV/V, situation B).

Below you will find a comparison of which standard meets which criteria:

Comparison of DIN EN ISO 376 and DKD-R 3-3

| | ISO 376 | DKD-R 3-3 |
|----------------------------------|---|--|
| Standardization | ISO standard (internationally standardized) | Standard of the DKD (Germany) |
| Measuring equipment | Force transducers and complete measuring chains | Force transducers and complete measuring chains |
| Area of application | Specifically force gauges for the testing of testing equipment | General force gauges |
| Number of power stages | 8 | 5 |
| Classification/Assessment | Classification in classes 00; 0,5; 1 and 2 | None in standard |
| Test sequences | Fixed procedure | Sequences A, B, C, D possible Standard is sequence A B, C and D are reduced sequences, relevant previous knowledge is necessary |
| Summary | Higher-quality calibration, as 8 force levels are calibrated | High-quality calibration, reduced sequences with less effort possible |

We can offer you a calibration solution for the following situations:

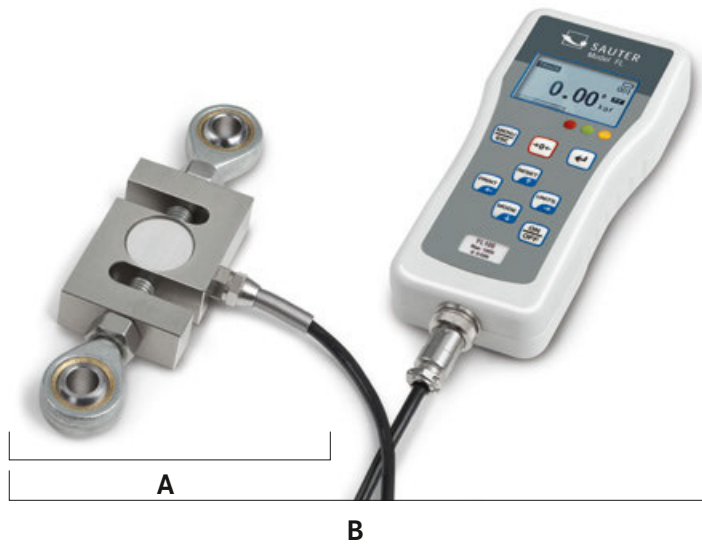

Situation A:
Separate force transducer,
display unit mV/V

Situation B:
Complete force gauge (N),
consisting of transducer, amplifier
and display, display unit N

► See also tables, right side

You can find further information on this topic at: www.kern-lab.com

KERN & SOHN GmbH
Akkreditiertes Kalibrierlabor seit 1994.
 Accredited calibration laboratory since 1994.

Ihr Partner für Kalibrierdienstleistungen, Prüfmittelmanagement und Beratung.
 Your partner for calibration services, test equipment management and support.

Mitglied im / member of the

Deutschen Kalibrierdienst

Sample
D.Nr.
19408-01-00
2025-01

Kalibrierschein
Calibration Certificate

Sample-2025-01

Kalibrierzeichen
Calibration mark

Gegenstand
Objekt

Kraftmessgerät
Force gauge

Max. 1000 N, dr 0,5 N

Hersteller
Manufacturer

Sauter GmbH
Zugzeile 1
72336 Balingen
Deutschland

Typ
Type

PH 1K

Seriennummer
Serial number

542H02287

Auftraggeber
Customer

Musterfirma GmbH
Musterstraße 1
12345678

Messwerte (Zugkraft) / Measurement results (tension force)

| Ausrichtung Kraft | Ausgangsposition / initial position | | 120° | | 240° | |
|----------------------|-------------------------------------|----------|----------|----------|----------|----------|
| Kraft force | R1 | R2 | R3 | R4 | R5 | R6 |
| 0,5 N | 0,5 N | 0,5 N | 0,5 N | 0,5 N | 0,5 N | 0,5 N |
| 200,0 N | +199,5 N | +199,5 N | +199,5 N | +199,5 N | +199,5 N | +199,5 N |
| 400,0 N | +399,5 N | +399,5 N | +399,5 N | +399,5 N | +399,5 N | +399,5 N |
| 600,0 N | +599,5 N | +599,5 N | +599,5 N | +599,5 N | +599,5 N | +599,5 N |
| 800,0 N | +799,5 N | +799,5 N | +799,5 N | +799,5 N | +799,5 N | +799,5 N |
| 1000,0 N | +999,5 N | +999,5 N | +999,5 N | +999,5 N | +999,5 N | +999,5 N |
| 0 N | 0,5 N | 0,5 N | 0,5 N | 0,5 N | 0,5 N | 0,5 N |

Messergebnisse (Zugkraft) / Measured values (tension force)

Aus den oben aufgeführten Messwerten ergeben sich die folgenden Messergebnisse:
 The following measurement results are calculated using the measured values above:

Rel. Kalibrierabweichung / Rel. cal. max. load error: $s_k = 0,000\%$
 Rel. Nullpunktabweichungen / Rel. zero error: $f_0 = 0,000\%$ (R1), $0,000\%$ (R2), $0,000\%$ (R3/R4), $0,000\%$ (R5/R6)

| Kraft force | Mittelwert \bar{x} average \bar{x} | rel. Wiederholgenauigkeit r' rel. repeatability r' | rel. Vergleichspräzision s' rel. reproducibility s' | rel. Umkehrspanne v rel. hysteresis v |
|----------------|---|---|--|--|
| 200,0 N | +199,5 N | 0,000% | 0,000% | +0,251% |
| 400,0 N | +399,5 N | 0,000% | 0,000% | 0,000% |
| 600,0 N | +599,5 N | 0,000% | 0,000% | 0,000% |
| 800,0 N | +799,5 N | 0,000% | 0,000% | +0,063% |
| 1000,0 N | +999,5 N | +0,050% | +0,050% | 0,000% |

Angaben in die erweiterte Messunsicherheit, die sich aus der Standardmessunsicherheit durch Multiplikation mit dem Erweiterungsfaktor $k=2$ ergibt. Sie wurde gemäß EN 4502 Nr. 2(2) und DKD-R 3-3 ermittelt und gilt jeweils für Messungen zwischen der angegebenen Kraftstufe und der Kalibrierhöhekraft. Der Wert der Messgröße liegt mit einer Wahrscheinlichkeit von mindestens 95% im angegebenen Messbereich.

Calibration certificate with accreditation symbol
for force-measuring devices (extract).

Prices for accredited calibration of force gauges and force transducers

Situation A: Force transducer (voltage ratio, in mV/V)*^{1,2}

| ISO 376 (8 stages) | | | DKD-R 3-3 (5 stages, sequence A) | | |
|---------------------------------------|-----------------|-------------------------------|----------------------------------|-----------------|-------------------------------|
| KERN | Measuring range | Price € ex works excl. of VAT | KERN | Measuring range | Price € ex works excl. of VAT |
| Tensile force: | | | | | |
| 963-161IV (R) | ≤ 500 N | 250,- | 963-161V (R) | ≤ 500 N | 235,- |
| 963-162IV (R) | ≤ 2 kN | 300,- | 963-162V (R) | ≤ 2 kN | 280,- |
| 963-163IV (R) | ≤ 5 kN | 390,- | 963-163V (R) | ≤ 5 kN | 360,- |
| Compression force: | | | | | |
| 963-261IV (R) | ≤ 500 N | 250,- | 963-261V (R) | ≤ 500 N | 235,- |
| 963-262IV (R) | ≤ 2 kN | 300,- | 963-262V (R) | ≤ 2 kN | 280,- |
| 963-263IV (R) | ≤ 5 kN | 390,- | 963-263V (R) | ≤ 5 kN | 360,- |
| Tensile and Compression force: | | | | | |
| 963-361IV (R) | ≤ 500 N | 420,- | 963-361V (R) | ≤ 500 N | 390,- |
| 963-362IV (R) | ≤ 2 kN | 500,- | 963-362V (R) | ≤ 2 kN | 465,- |
| 963-363IV (R) | ≤ 5 kN | 670,- | 963-363V (R) | ≤ 5 kN | 610,- |

Situation B: Complete force gauge (in N)*²

| ISO 376 (8 stages) | | | DKD-R 3-3 (5 stages, sequence A) | | |
|---------------------------------------|-----------------|-------------------------------|----------------------------------|-----------------|-------------------------------|
| KERN | Measuring range | Price € ex works excl. of VAT | KERN | Measuring range | Price € ex works excl. of VAT |
| Tensile force: | | | | | |
| 963-161I (R) | ≤ 500 N | 205,- | 963-161 (R) | ≤ 500 N | 187,- |
| 963-162I (R) | ≤ 2 kN | 250,- | 963-162 (R) | ≤ 2 kN | 225,- |
| 963-163I (R) | ≤ 5 kN | 345,- | 963-163 (R) | ≤ 5 kN | 315,- |
| Compression force: | | | | | |
| 963-261I (R) | ≤ 500 N | 205,- | 963-261 (R) | ≤ 500 N | 187,- |
| 963-262I (R) | ≤ 2 kN | 250,- | 963-262 (R) | ≤ 2 kN | 225,- |
| 963-263I (R) | ≤ 5 kN | 345,- | 963-263 (R) | ≤ 5 kN | 315,- |
| Tensile and Compression force: | | | | | |
| 963-361I (R) | ≤ 500 N | 375,- | 963-361 (R) | ≤ 500 N | 340,- |
| 963-362I (R) | ≤ 2 kN | 460,- | 963-362 (R) | ≤ 2 kN | 420,- |
| 963-363I (R) | ≤ 5 kN | 620,- | 963-363 (R) | ≤ 5 kN | 560,- |

Factory calibration for force

This is not an accredited calibration (no proof of metrological traceability).

Situation A: Force transducer (voltage ratio, in mV/V)*^{1,2}

Situation B: Complete force gauge (in N)*²

| Situation A: Force transducer (voltage ratio, in mV/V)* ^{1,2} | | | Situation B: Complete force gauge (in N)* ² | | |
|--|-----------------|-------------------------------|--|-----------------|-------------------------------|
| KERN | Measuring range | Price € ex works excl. of VAT | KERN | Measuring range | Price € ex works excl. of VAT |
| Tensile force: | | | | | |
| 961-161V (R) | ≤ 500 N | 235,- | 961-161 (R) | ≤ 500 N | 187,- |
| 961-162V (R) | ≤ 2 kN | 280,- | 961-162 (R) | ≤ 2 kN | 225,- |
| 961-163V (R) | ≤ 5 kN | 360,- | 961-163 (R) | ≤ 5 kN | 315,- |
| 961-164V (R) | ≤ 20 kN | 460,- | 961-164 (R) | ≤ 20 kN | 410,- |
| 961-165V (R) | ≤ 50 kN | 460,- | 961-165 (R) | ≤ 50 kN | 410,- |
| 961-166V (R) | ≤ 250 kN | 495,- | 961-166 (R) | ≤ 250 kN | 455,- |
| Compression force: | | | | | |
| 961-261V (R) | ≤ 500 N | 235,- | 961-261 (R) | ≤ 500 N | 187,- |
| 961-262V (R) | ≤ 2 kN | 280,- | 961-262 (R) | ≤ 2 kN | 225,- |
| 961-263V (R) | ≤ 5 kN | 360,- | 961-263 (R) | ≤ 5 kN | 315,- |
| 961-264V (R) | ≤ 20 kN | 460,- | 961-264 (R) | ≤ 20 kN | 410,- |
| 961-265V (R) | ≤ 50 kN | 460,- | 961-265 (R) | ≤ 50 kN | 410,- |
| 961-266V (R) | ≤ 250 kN | 495,- | 961-266 (R) | ≤ 250 kN | 455,- |
| Tensile and Compression force: | | | | | |
| 961-361V (R) | ≤ 500 N | 390,- | 961-361 (R) | ≤ 500 N | 340,- |
| 961-362V (R) | ≤ 2 kN | 465,- | 961-362 (R) | ≤ 2 kN | 420,- |
| 961-363V (R) | ≤ 5 kN | 610,- | 961-363 (R) | ≤ 5 kN | 560,- |
| 961-364V (R) | ≤ 20 kN | 660,- | 961-364 (R) | ≤ 20 kN | 610,- |
| 961-365V (R) | ≤ 50 kN | 660,- | 961-365 (R) | ≤ 50 kN | 610,- |
| 961-366V (R) | ≤ 250 kN | 720,- | 961-366 (R) | ≤ 250 kN | 670,- |

(R): Recalibration

For each force gauge without interface or from other manufacturers we charge a surcharge of € 10,- for the additional effort.

*¹ Compatibility with our amplifiers required

*² Installation in our measuring equipment required

Factory calibration certificates

As calibration certificates with accreditation symbol cannot be offered for all measuring devices or measurement sizes, or where it is not customary, we then offer factory calibration certificates. This is not an accredited calibration (no proof of metrological traceability). These calibration certificates meet international standards and are particularly suitable as proof of exacting calibration in the monitoring of your checking equipment, for example:

- Mechanical balances (spring balances, etc.)
- Force-measuring devices up to 250 kN
- Measuring devices for layer thickness 0 µm – 2000 µm
- Hardness testing devices in accordance with Leeb tests
- Ultrasonic material thickness testing device 25 mm – 300 mm

We carry out calibrations independent of brand. In order to avoid any unnecessary delays when processing your order, please send us the technical documents and necessary accessories with the checking device. Calibration time 4 working days.

| KERN | Measuring device | Measuring range | Price excl. of VAT ex works € |
|----------------------------|--|--|-------------------------------|
| Factory calibration | | | |
| 961-110 | Coating thickness | ≤ 2000 µm F or N | 167,- |
| 961-112 | Coating thickness | ≤ 2000 µm FN | 235,- |
| 961-113 | Wall thickness (ultra sound) | ≤ 300 mm (in stainless steel) | 167,- |
| 961-114 | Wall thickness (Test blocks) | ≤ 300 mm | 208,- |
| 961-170 | Hardness comparison plate (Shore) | For sets up to 7 plates | 132,- |
| 961-131 | Hardness tester (Leeb) | 400 – 800 HLD | 167,- |
| 961-132 | Hardness comparison plate (Leeb) | Hardness comparison plate (for Leeb durometer) | 167,- |
| 961-270 | Hardness (UCI) | 200 – 800 HV | 360,- |
| 961-150 | Length | ≤ 300 mm | 167,- |
| 961-190 | Light | ≤ 200000 lx | 325,- |
| 961-100 | Mechanical balances/spring balances | ≤ 5 kg | 99,- |
| 961-101 | Mechanical balances/spring balances | > 5 – 50 kg | 123,- |
| 961-102 | Mechanical balances/spring balances | > 50 – 350 kg | 146,- |
| 961-103 | Mechanical balances/spring balances | > 350 – 1500 kg | 225,- |
| 961-102K | Digital dynamometer KERN MAP | ≤ 130 kg | 167,- |
| 961-120 (R) | Torque wrench test devices | 1 Nm - 200 Nm | 235,- |
| 964-305 | Temperature calibration for moisture analyzer* | | 174,- |
| 961-290 | Refractometers | | 135,- |
| Additional services | | | |
| 962-116 | Express service with 48 hour delivery | | 52,-/ instrument |

(R): Recalibration

For each force gauge without interface or from other manufacturers we charge a surcharge of € 10,- for the additional effort.

*For an overview of calibratable instruments and test services for further measuring sizes see www.kern-lab.com

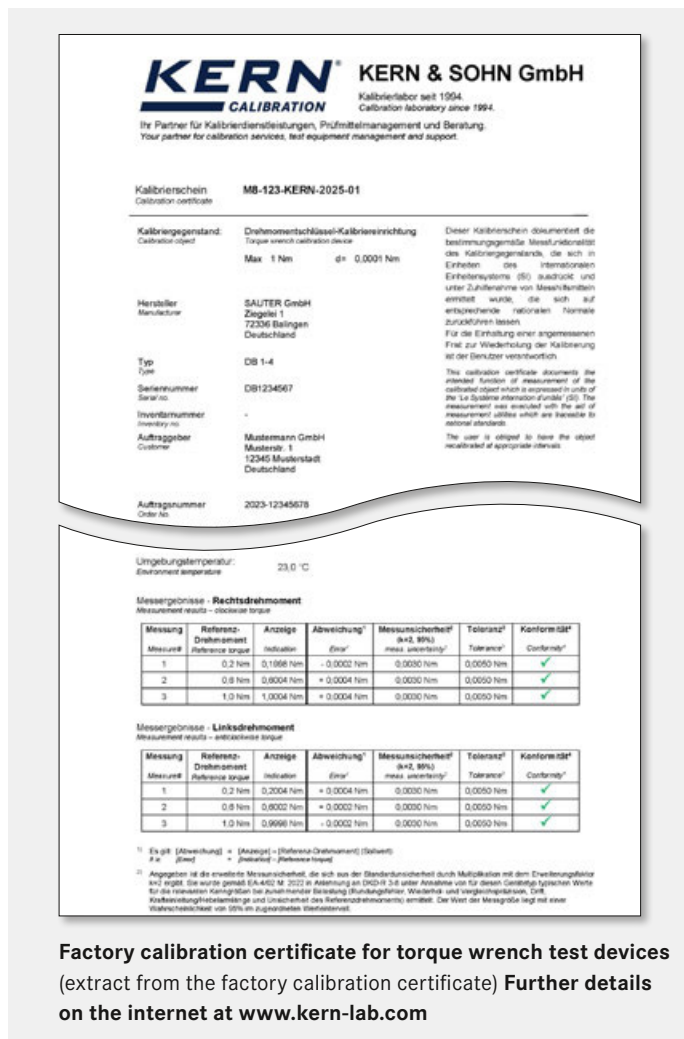

Factory calibration certificate for torque wrench test devices (extract from the factory calibration certificate) **Further details on the internet at www.kern-lab.com**

A

Accuracy classes for test weights

E, F, M ▶ *Error limit classes*

Adjusting of measurement equipment

Precise setting of a measurement value via a professional intervention in the measurement system.

Adjusting the weighing range of a balance



Either with the external test weight via the **adjusting program CAL**, or with the **internal automatic adjustment** resp. **adjusting switch**. It is necessary with variations in temperature, a change of environmental conditions, change of location, etc. Recommended as a daily check routine.

Alibi memory

For weighings where verification is mandatory, and which are to be analysed and processed by a PC (e.g. printing out a packing list using a PC instead of a printer connected directly to the balance) electronic archiving is required by the metrological authorities by a verifiable data memory which cannot be manipulated. Alibi memories from KERN fulfil this requirement. They are for paperless archiving of weighing results. For KERN products the alibi memory is fitted inside the balance, right between where the weight is determined and the output to the PC.

All data transferred to the PC is stored with date, time and all important weights for at least three months. These stored data strings can be displayed on the balance at any time. The data in the alibi memory can be deleted, but not changed.

Application accuracy

Allowance for measuring uncertainty during practical use of a balance. Is given in the appendix to the DKD calibration certificate.

ATEX

Derived from **AT**mosphère **EX**plosibles. (explosive atmosphere). A synonym for EU guidelines, which controls the quality and use of equipment in hazardous industrial environments, where there is explosion danger, e.g. by handling of flammable substances, which are present in high concentrations in the form of gas, mist, vapour or dust. Therefore see also directives 2014/34/EU as well as 1999/92/EU.

B

Balances which are verified/ not approved for verification

Metrologically almost identical. For verified balances certain details are regulated by law, e.g. software changes and additional markings.

C

CAL

Adjusting the balance is triggered with an external test weight by using the CAL key on the key pad or on the touch display of the display device or the CAL menu option. This will guarantee the consistent high accuracy of the balance.

Calibration of measurement equipment

Determination of the precision of a measurement value without intervention in the measurement system. Example: to check a balance you load a ▶ **test weight** upon it. The term “Calibrating” was formerly also used for ▶ **Adjusting**.

Calibration Certificate DKD/DAkkS

See *product group 18 “Calibration service”*



Calibration or verification



DAkkS-Calibration is possible for every balance in perfect condition. DAkkS calibration (DKD) is a private service monitored by the state for ensuring high quality requirements according to ISO 9000ff and others, e.g. in production or research. **Verifying (conformity assessment)** is only possible for type-approved balances marked with the green **M** ▶ **Verification**

Commercial error limit

Permitted tolerance (plus and minus) of measuring devices where verification is mandatory when used within their verification validity period. This tolerance is double the permissible error limit, in so far as this is not specified otherwise in the Weights and Measures Act).

Conformity assessment

Procedure for confirming warranted characteristics in accordance with recognised rules. For balances this relates to verification.

Conformity declaration from the manufacturer

The manufacturer declares that the product fulfils the applicable EU directives. With electronic balances this is always in conjunction with the CE mark.

Control of measuring equipment in the QM system in conjunction with quality standards

An organisation certified to a quality standard such as DIN EN ISO 9001 ff. e.g. a production plant is obliged to adhere to a defined quality standard within the framework of its quality management system. To do this, it is imperative to have a measurement equipment which is working accurately. Chapter 7.1.5 “Resources for monitoring and measuring” of DIN EN ISO 9001:2015-11 states that measuring equipment must be calibrated at defined intervals and before use. The measurement devices and measurement standards needed to do this must:

- be traced back to international or national standards.

(▶ **Traceability to the National Standard**)

- their uncertainty of measurement must be known
- they must be marked with a clear identification
- the test must be documented

The ▶ **DAkkS calibration (DKD)** fulfils all these requirements.

Conventional mass of weights

The problem is the air movement, which makes the weight appear lighter. In order to avoid this “distortion” in daily use, all weights are adjusted to the unit specifications given in R111, e.g. it is accepted that: material density of the weights is 8000 kg/m³, air density is 1.2 kg/m³ and measuring temperature is 20° C.

Counting resolution

The counting resolution is calculated in points from the ratio of the weighing range [Max] divided by the smallest part weight. It is a statement of counting accuracy.

D

DAkkS =

German accreditation authority

▶ **Calibration Certificate DKD/DAkkS**

See *product group 18 “Calibration service”*



Data interface

To connect the balance to a printer, PC, network or a second balance. Typical interfaces are, for example, RS-232, RS-485, USB, Bluetooth, LAN, Digital I/O, DUAL, LAN etc. The interface parameters can be set using the balance. The interfaces available are stated in the model description.

Density determination

One of the main areas of application for laboratory balances is determining densities, e.g. determining the specific weight of liquids and solids. To do this you will need a highly accurate precision or analytical balance and a density set. It is particularly convenient if the balance can calculate and display the density right away. It has become apparent that by means of weighting when in the process of determining the density of liquids and solids according to the buoyancy method particularly accurate results can be obtained (Archimedes' principle).

- Density determination of liquids: By means of measuring the buoyancy with a glass plummet with known volume immersed in the liquid to be measured

- Density determination of solid bodies:

$$\rho = \frac{A}{A-B} \cdot \rho_0$$

ρ = Density of sample

A = Weight of sample in air

B = Weight of sample in auxiliary liquid

ρ_0 = Density of the auxiliary liquid

Applications:

- Pre-packaged goods control, whenever a product is sold according to its volume [cm³]. This volume is calculated with weight [g] : density [g/cm³].
- Materials analysis

DMS = Strain gauge

An electrical resistor strip that is glued to an elastic deforming body made of aluminium. As the strain gauge is mechanically deformed its resistance value changes, allowing the measured value to be calculated.

**Draught shield**

Required for balances with ► **Readout** $d \leq 1$ mg, to avoid disturbing air movements.

Dual-range balance

As the load increases, the balance switches automatically to the next largest range, for both, weighing range [Max] as well as readout [d].

E**Error limit classes for test weights according to EU directive OIML R111**

For further details, see product group 17 "Test weights"

F**FACTORY**

These options can only be carried out at KERN factory.

FORCE = Electromagnetic force compensation

A counterforce is created by means of a coil in a permanent magnet. This counterforce is the same as the load of the weight being measured on the scale and therefore equalising. The measured value is calculated via the change in the coil current.

G**GLP = Good Laboratory Practice**

► **ISO/GLP**

Gravitational acceleration

► **Gravitational force**

Gravitational force

very important influence for precise electronic balances. Due to the varying influence balances have to be ► **adjusted at the location of use.**

H**HACCP = Hazard Analysis and Critical Control Points (HACCP)**

The HACCP concept is a preventative system, which is designed to guarantee the safety of foodstuffs. EC regulation 852/2004 mandates the use of the HACCP concept for all companies which are involved in production, processing and sales of foodstuffs.

I**ISO 9000ff/DIN EN ISO 9000ff**

Quality Management System in the form of a DIN Norm for quality assurance in a factory.

ISO calibration/ISO certificate**= factory calibration certificate**

Testing measurement devices for accuracy in accordance with a procedure which is recognised, but not accredited.

**ISO/GLP record keeping**

Quality Assurance Systems demands record keeping of weighing results and correct adjusting of the balance, giving details of date, time and balance identification. The easiest way to obtain this documentation is by means of a connected printer.

J**Junction Box**

For connection and simple corner adjustment of several load cells.

K**KCP**

KCP is an universal communication protocol between laboratory balances, industrial scales or other measuring instruments and digital devices, such as a computer, server or process management system. Due to the universal protocol structure, one measuring instrument can be replaced by another without adapting the communication interface.

L**Linearity/Precision**

Greatest deviation of the weight displayed of a balance with regard to the value of the respective test weight in terms of plus and minus across the whole weighing range.

M**Minimum load [Min]**

Lower limit of the verifiable weighing range. Is marked on the verification mark. The function of the balance is also given below the minimum load.

Minimum sample weight

Indicates the smallest weight which can be determined, depending on the process accuracy required.

Multi-division balance/**Multi-range balance**

On multi-division balances, the weighing range is subdivided several times, each with a different readability. The readability [d] changes automatically with increasing and decreasing load. Multi-range balances have several weighing ranges with different maximum loads and different numerical increments. Switching takes effect automatically when the load increases; switching back to the lower weighing range only takes effect when the scale has been completely unloaded.

N**Newton**

Newton (N) is the unit for physical force values. A Newton is the force required to accelerate a 1 kg mass at rest to a speed of 1 m/s within one second.

Notified body

Neutral and independent, predominantly government bodies, which are formally appointed by the EC. They are engaged in the field of verification for conformity evaluations (initial verification) and type-approval test within the scope of type approvals.

O**Optimisation of reference weight (when piece counting)**

See product group 9

"Counting balances/Counting systems"

P**Percentage determination**

Example: Reference weight prior to drying: 50 g = balance display 100 %. After drying 40 g = balance display 80 % absolute (dry mass) or 20 % relative (humidity).

Permissible ambient temperature

Measuring errors are possible if you use the balances outside the permitted specified ambient temperature range. With verified balances this is stated on the identification plate.

PLU (Price Look Up)

This refers to a data memory in price-computing retail scales for the base price of sales items.

Pre-packaging legislation (FPVO)

Ensures that pre-packed goods are filled correctly, for example, in food industry. The Weights and Measures Act governs the permissible weight and volume tolerances.

PRE-TARE

Entering and saving a tare weight (e.g. container weight) through weighing or manual entry using the balance keypad before the actual weighing process. When you subsequently place the tare container on the balance, the balance will show zero immediately – saves time. Particularly useful e.g. for checking fill levels

Proof of compatibility

This documents the verification compatibility for combinations of weighing modules such as display devices, load cells and connecting elements.

R**Readout [d]**

Smallest readable weight increment on a digital display.

Recalibration

Periodic checking of the precision of measurement equipment/checking equipment (e.g. balances/weights) to control accuracy,
 ▶ **Control of measurement equipment**

Reference weight

(when piece counting)

See *product group 9*

“Counting balances/Counting systems”

Reproducibility (standard deviation)

Sequenced measure of conformity in repeated weighing (e.g. balances) subject to the same conditions. Mostly 1 [d] or less. Quality feature.

Resolution of a balance

The resolution is calculated from the weighing range [Max] divided by the readout [d], e.g. [Max] 420 g : [d] 0.001 g = 420,000 points. The resolution is a quality feature – the higher, the better.

S

SC-TECH = Single-Cell Technology

▶ **FORCE**. The load cell consists of a single aluminium block, which gives a very high measurement quality.



Semi-micro balance

Analytical balance with a readout [d] = 0,01 mg

Smallest part weight when counting

The smallest piece weight, which a balance can accept for piece counting. For the relevant model, enter “g/piece” in the product data table.

T

T-FORK = Tuning fork principle

A resonating body (like a tuning fork) is electromagnetically excited, causing it to oscillate. The measured value is calculated via the change in frequency corresponding to the load of the weight being measured on the scale.



Taring, automatic

▶ **PRE-TARE**

Taring, subtractive

The available weighing range of a balance is reduced by the value of the tare load. Example: weighing range of a balance Max 6000 g, Tare (= container) 470 g, available weighing range 5530 g.

Test weight, external

(previously calibration weight)

For adjusting or checking the balance accuracy

▶ **Adjusting the weighing range**.

The external test weight can be DAkkS calibrated at any time, even afterwards, see *product group 18 “Calibration Service”*.



Test weight, internal

Like test weight external, but installed in the balance and powered.



Totalising

Various individual weighings are added automatically to aggregate, e.g. all individual weighings of a batch.



Traceability to the National Standard

A pre-requisite for every perfect measurement is the validated comprehensive proof that the measuring equipment can be traced back to the international or national standards. In Germany the statutory binding standards are available from the PTB.

Type approval for balances

Strict process to test whether a balance fulfils the verification requirements. A balance can only be verified, if it has got a type approval from a
 ▶ **notified body**.

U

Uncertainty of measurement of a balance (= standard deviation)

Determined for each balance according to a precisely given test method and documented in the
 ▶ **Calibration certificate**. It depends on various factors, both, internal and external. Uncertainty of measurement increases by a rising charge of the balance, see *product group 18 “Calibration Service”*

V

Verification

Verification, in accordance with the new terminology “Conformity assessment”. Only balances with ▶ **EC type approval** can be evaluated for conformity. These balances have an identification plate with the metrology marking **M**. The state requires assessment for conformity and this assessment serves as consumer protection. According to EU directive 2014/31/EEC balances must be officially assessed for conformity (calibrated) if they are used as follows:

- in commercial trade when the price of a commodity is determined by weighing.
- in the manufacture of pharmaceuticals in pharmacies and analysis in pharmaceutical and medical laboratories.
- for official purposes.
- in the production of prepackaging.
- in medical applications.

Every balance is tested by KERN and marked with a conformity mark. Its accuracy within the framework of permissible tolerances is thereby confirmed. EU verification applies to all member states of the EU.

Verification classes of balances

Class I – Analytical balance (precision balance),
 Class II – precision balance,
 Class III – industrial scale (commercial scale).



Verification of a balance with adjusting program CAL EXT

The adjusting program is sealed with an official mark after the verification. Thus the verification is only valid for the specific location of use.

▶ **Gravitational force**

To be able to correctly adjust the balance to your location of use, it is necessary to advise the location of use and postcode. See individual model details for the information as to whether verification can be carried out in the factory or at the location of use.

Verification of a balance with automatic internal adjusting CAL INT

The above restrictions in respect of the location of use do not apply, because the automatic internal adjusting works also after verification, therefore it is not sealed. In this case, verification does not depend on the location.

Verification validity for balances

Generally 2 years for all verification classes, for control balances generally 1 year, after expiry the balance has to be re-verified.

Verification value [e]

Measure of the verification tolerance, depending on balance, mostly between 1 [d] and 10 [d] ▶ **Readout**

W

Weighing range [Max]

is the working range of the balance. The balance can be loaded up to the specified upper limit.

COMMITMENT TO QUALITY AT AN INTERNATIONAL LEVEL



Partners with experience and competence are an essential factor for process-oriented processes in professional weighing and measuring technology. With KERN you have a service partner by your side who has a state-of-the-art test service with an accredited calibration laboratory. Our colleagues are available both for technical questions and also individual solutions and will be glad to help you.

The following accreditations and certificates represent our commitment to quality: Certified QM system DIN EN ISO 9001, DAkkS Accreditation DIN EN ISO/IEC 17025, conformity evaluation in accordance with NAWID: 2014/31/EU, Medical certifications DIN EN ISO 13485 and 93/42/EEC.

You can also find further information online, please see www.kern-lab.com



Accredited calibrations according to DIN EN ISO/IEC 17025:2018 norms for balances, weights, force, volumes of solid bodies, densities of solid bodies, temperature, humidity



CONFORMITY ASSESSMENT ACCORDING TO NAWID: 2014/31/EU

Retailer Information

Sales Conditions

All prices are valid as of January 1st 2025, Subject to change without notice. Current prices at www.kern-sohn.com. In Europe, all prices do not include the applicable V.A.T.

Delivery Conditions

We supply ex works Balingen, e.g. the transport costs are invoiced. With our contract logistics partners we always offer you shipping at a good rate. When shipping to islands or other more distant areas, or areas which are difficult to access, the transport costs may possibly be higher, please ask for details. Any goods supplied remain KERN's property until complete payment for the goods sold has been received.



Delivery is usually via courier service.



When you see this symbol by truck, please ask for prices.n.

Extract from general terms and conditions

Court of jurisdiction/Legal domicile:

72336 Balingen, Germany;
Commercial register N°: HRB 400865,
AG Stuttgart; Managing director: Albert Sauter
For the full Terms and Conditions,
please refer to the website.

<https://www.kern-sohn.com/shop/en/IMPRESSUM/AGB2/>

All dimensions are approximate. Technical changes in the course of further development, printing faults, price changes and product changes are likely in individual cases, due to product modifications as well as error.

Sale or return

within 14 days of purchase. Not valid for Software and order-specific adaptations such as special productions, cable extensions, special weights, etc. or test services such as calibration, verification, etc. Depending on the time and effort involved, there may be processing and storage costs, please ask for details.

Warranty

→ 3 years for products with list price \geq € 500.00

→ 2 years for components as well as products with list price $<$ € 500.00

→ 1 year for pallet truck scales

Does not apply to consumables such as batteries, rechargeable battery packs, etc.

Balances in areas regulated by law (► *Verficiation*) must comply with the commercial error limits during the period of validity for verification – these are usually double the verification permissible error limits. If this period of validity for verification expires, then reverification must be carried out. If, in order to pass the verification, it should be necessary to adjust the balance to comply with the verification permissible error limits, then this does not constitute a warranty claim.

Service

KERN DirectCash

The quick, secure COD procedure for protection against non-payment. With the KERN DirectCash COD system, you can safely deliver orders to end customers with unknown credit rating, with no risk of non-payment. Please request further details on this procedure.

Hire Purchase

Financing is available using KERN hire purchase – easy and convenient. Hire Purchase gives you the option of purchasing any product from our range against a simple monthly installment. The product value is financed over the period of the agreement. On payment of the last installment, the ownership of the contract item automatically transfers from the contractor to the contractee. The Hire Purchase Agreement can – if you so choose – be set for a period of between one and five years. This package includes the transfer of items as well as the guarantee for the entire transfer period.

Compared with buying the product, KERN hire purchase offers the advantage that the initial financial investment is largely unnecessary. This is particularly relevant when purchasing a number of products, for example when refitting a laboratory, a company department or a hospital ward. In addition the monthly installments constitute a direct cost and the item does not have to be capitalised by the purchaser.

After-Sales-Service

Repair service

Within 1 week at our plant in Balingen, transportation costs are additional. In urgent cases, if requested by customer, a replacement device will be provided until all repairs are completed; please ask.

Price reduction for a new device

If repair costs exceed the current value of the defective device, a new device will be offered for a discount price. This offer is valid only up to 2 years after warranty expiration.

Spare parts service

Usually within 48 hours, transportation costs are additional.

Marketing Support

KERN catalogues, brochures, branch prospectuses – your own personalised marketing tools

This catalogue and branch prospectuses are available free of charge. A neutral version of the catalogue, without the KERN address imprint, is also available free of charge for your marketing activities as PDF document. The KERN catalogue and branch prospectuses are available in the following languages: DE, EN, FR, IT, ES.

Important Notice

Explosion hazard/Humidity

Our models are not suitable for rooms with a risk of explosion. Our models are also not suitable for rooms with a high level of air humidity (condensing). Please observe the applicable electrical regulations.

Earth's gravitational force

Electronic balances are subject to location regulations due to the earth's gravitational force. If location of use is changed, reverification and recalibration of the electronic balance is needed.

Calibration Certificate with Accreditation Symbol

Upon request, you will receive a Calibration Certificate with accreditation symbol (Deutsche Akkreditierungsstelle GmbH – German accreditation point), which documents the precision of your balance in detail and also serves as your proof that you monitor your checking equipment in a Quality Management System to ISO 9001.

Accessories

Further extensive accessories for all our models can also be found in the KERN online shop www.kern-sohn.com

The oldest Precision Balance Factory in Germany

KERN & SOHN GmbH

Balances, Test Weights, Microscopes,
DAkKS Calibration Laboratory

Ziegelei 1
72336 Balingen
Germany
Tel. +49 7433 9933-0
info@kern-sohn.com
www.kern-sohn.com

Discover the multifaceted World of Balances, Microscopes and Measuring Technology
from KERN online: www.kern-sohn.com



- Full KERN & SAUTER Product Range
- Extensive Information and useful Download Options
- Useful KERN Services
- Convenient 24/7 Ordering
- Technical Product Data Sheets
- Technical Glossary
- Selection of more than 5,000 Items across Weighing and Measuring Technology, Optical Instruments as well as Accessories and Services
- Operating Instructions
- KERN Dealer Portal
- Descriptive Image and Video Material
- Practical Filter and Search Functions



Follow us on our social media channels too



Printed in Germany by KERN & SOHN GmbH
z-cb-en-4p-20251

